**User's
Manual**

**Model DX102L/DX104L/DX106L/DX112L
DAQSTATION DX100L**

vigilantplant®



Setting Items in the Setting Mode (Enclosed in parentheses are references.)

Soft key	Title	Item
#6	File (8.9)	Header string to be written to file Name of directory to which data are to be saved Range of data to be saved during manual save Daylight savings time (10.14)
#7		Save/Load, Clear data
#7 - #1	Save settings	Save setup data to the external storage medium (9.1)
#7 - #2	Load settings	Load setup data from the external storage medium (9.1)
#7 - #3	Save data	Store measured data using key operation (9.2)
#7 - #4	Load display data	Load the display data on the external storage medium (9.3)
#7 - #5	Load event data	Load the event data on the external storage medium (9.4)
#7 - #5	File list	List the files on the external storage medium (9.5)
#7 - #6	Delete	Delete files on the external storage medium (9.5)
#7 - #7	Format	Format the external storage medium (9.5)
#7 - #8	Clear data	Clear the measure/computed data in the internal memory (9.7)
#8	Time set (3.7)	Enter the current time
#9	Math range (11.4)	Computing equations, display span, and unit for computation channels
	Math alarm (11.5)	Alarm type for the computation channel Alarm value for the computation channel Output relay On/Off for the computation channel Output relay number for the computation channel
#10	Constant (11.6)	Constants (K01 to K12)
#11	Tag (7.1) TLOG (11.7) Rolling average (11.10)	Tag names of the computation channels Timer number used in TLOG, sum unit Turn On/Off the rolling average Sampling interval and the number of samples for the rolling average
#12	Batch set (10.12)	Application name, Supervisor name, Manager name, Batch number, Lot number, Auto increment, Display information

Quick**Reference**

Model DX102L/DX104L/DX106L/DX112L
DAQSTATION DX100L

Use this quick reference together with the user's manual IM 04L04A01-01E.

Operation Screens

Trend/Digital/Bar graph/Information (Alarm Summary/Message Summary/Memory Summary)/Historical Trend

Switching Operation Screens

Press the DISP/ENTER key to display the screen menu or the operation screen.

Press the up, down, right, or left arrow key to select the operation screen.

Sampling Interval and Sampling length for Display Data and Event Data

- When Acquiring the display data only from four measurement channels (The sampling length for the display data when acquiring both the display data and the event data is approximately 3/4 of the values in the table below.)

Display Update Rate	15 s	1 min	5 min	20 min	30 min	1 h	4 h	10 h
Sampling Interval (s)	0.5	2	10	40	60	120	480	1200
Sampling length (approx.)	10 h	41 h	8 days	34 days	52 days	104 days	416 days	1041 days
Sampling Interval (s)	125 ms	500 ms	1 s	5 s	30 s	120 s	600 s	
Sampling length (approx.)	4.2 h	16 h	33 h	6 days	41 days	166 days	833 days	

- When Acquiring the event data only from four measurement channels (The sampling length for the event data when acquiring both the display data and the event data is approximately 1/4 of the values in the table below.)

YOKOGAWA ◆

Yokogawa Electric Corporation

Run Mode

Operation Mode:
Setting Mode:
Basic Setting Mode:

Entered when the power is turned ON.
Entered by pressing the MENU key.
Entered by pressing the FUNC key for three seconds while the menu screen for the setting mode is displayed.

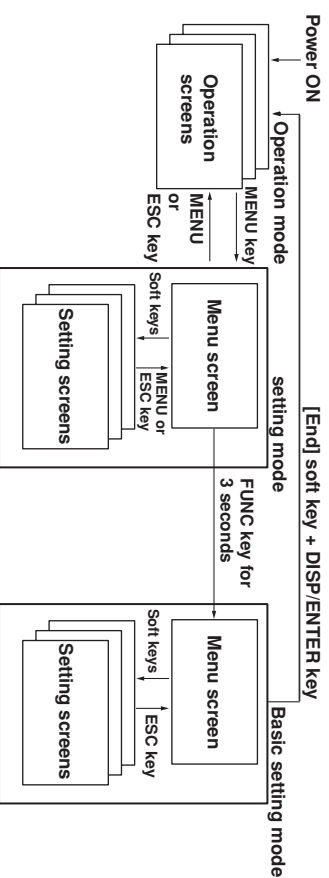

Returning to the operation mode:
from the operation mode:

Display the menu screen and press the MENU key or the ESC key.

from the basic setting mode:
Display the menu screen and press the [End] soft key to display a confirmation window. Select [Yes] and press the DISP/ENTER key to return to the operation mode.

key function

Batch	AlarmAck	Message	Manual sample	Key lock	Logout	Trigger	Math START
Math reset	Snap shot	Log	FTP test	E-Start START	E-Start test	Hodbus master	Field Bus
Save Display	Save Event						

NOTE

To avoid injury, death of personnel or damage to the instrument, the operator must refer to the explanation in the User's Manual or Service Manual.

Setting Items in the Setting Mode (Enclosed in parentheses are references.)

Soft key	Title	Item
#1	Range (5.1 to 5.7) Alarm (6.2)	Input type, span, scale, etc. Alarm type Alarm value Output relay On/Off Output relay number
#2	Tag (7.1) Filter (5.8) Moving average (5.8) Alarm delay time (6.3)	Tag name Filter time constant/Off (DX102L/DX104L) Number of samples for the moving average/Off (DX106L/DX112L)
#3	Trend/Save interval USER key (10.2)	Trend display update rate (7.3) Auto save interval (8.8) Assign an action to the USER key
#4	Message (7.5)	Message string
#5 - #1	Display Group set/Trip line	Group name (7.6) Assign channels to groups (7.6) Trip line position, display color (7.7)
#5 - #2	Color (7.8)	Measurement channel display color
#5 - #3	Zone (7.9) Graph (7.10)	Zone upper and lower limits Number of scale divisions for the trend and bar graph Bar graph base position Specify the scale display position for trends. Turn On/Off partial expanded display Position and boundary for the partial expanded display
#5 - #4	View (7.13)	Display direction (trend, bar graph) Background color (white or black) Trend line width Trip line width Grid for the trend display Interval for switching group displays (Scroll time) Scale digit LCD brightness Turn On/Off the LCD backlight saver Transition time for the LCD backlight saver and conditions that restore the backlight
	LCD (7.14)	

The #5 - #4 and #5 - #4 soft keys are for Color, Zone, Graph, and Partial settings for computation channels.

Foreword

Thank you for purchasing the YOKOGAWA DAQSTATION DX100L.

This User's Manual contains useful information about the functions, installation, wiring, operating procedures, and troubleshooting of the DX100L. To ensure correct use, please read this manual thoroughly before operation. Keep this manual in a safe place for quick reference in the event a question arises. In addition, a quick reference is provided on the previous page. This reference briefly explains operations that are used frequently. Separate this reference from the manual for use. The following four manuals, including this one, are provided as manuals for the DX100L.

Manual Name	Manual No.	Description
DX100L User's Manual	IM 04L04A01-01E	This manual. Explains all functions and procedures of the DX100L excluding the communication functions.
DX100/DX200 Communication Interface User's Manual	IM 04L02A01-17E	Explains the communication functions of the Ethernet/serial interface.
Fieldbus Communication Interface User's Manual	IM 04L02A01-18E	Explains the communication functions of the FOUNDATION Fieldbus interface. For models with /CF1.
DAQSTANDARD User's Manual	IM 04L41B01-61E	Included in the accompanying CD-ROM. Describes the functions and operating procedures of DAQSTANDARD that comes with the package.
Control of Pollution Caused by the Product	IM 04L01A01-92C	Gives a description of pollution control.

Notes

- This manual describes the DX100 style number "S4." For functions that have been added or changed on the DX100 style number "S4," see appendix 3.
- The contents of this manual are subject to change without prior notice as a result of continuing improvements to the DX100's performance and functions.
- Every effort has been made in the preparation of this manual to ensure the accuracy of its contents. However, should you have any questions or find any errors, please contact your nearest YOKOGAWA dealer.
- Copying or reproducing all or any part of the contents of this manual without YOKOGAWA's permission is strictly prohibited.
- The TCP/IP software used in this product and the documentation for that TCP/IP software are based in part on BSD Networking Software, Release 1 licensed from The Regents of the University of California.

Trademarks

- vigilantplant and DAQSTATION are registered trademarks of Yokogawa Electric Corporation.
- Microsoft and Windows are registered trademarks or trademarks of Microsoft Corporation in the United States and/or other countries.
- Adobe and Acrobat are registered trademarks or trademarks of Adobe Systems Incorporated.
- Company and product names that appear in this manual are registered trademarks or trademarks of their respective holders.
- The company and product names used in this manual are not accompanied by the registered trademark or trademark symbols (® and ™).

Revisions

First edition: February 2001 3rd edition: April 2008
Second edition: November 2003

Protection of Environment

Control of Pollution Caused by the Product



For details, see the Control of Pollution Caused by the Product (IM04L01A01-92C).

Proper Disposal of This Product

This is an explanation of how to dispose of this product based on Waste Electrical and Electronic Equipment (WEEE), Directive 2002/96/EC. This directive is only valid in the EU.

- **Marking**

This product complies with the WEEE Directive (2002/96/EC) marking requirement. The affixed product label (see below) indicates that you must not discard this electrical/electronic product in domestic household waste.



- **Product Category**

With reference to the equipment types in the WEEE directive Annex 1, this product is classified as a "Monitoring and Control instrumentation" product.

Do not dispose in domestic household waste. To return unwanted products, contact your local Yokogawa Europe B. V. office.

Safety Precautions

The DX100L conforms to IEC safety class I (provided with terminal for protective grounding), Installation Category II, and EN61326-1 (EMC standard), class A (use in a commercial, industrial, or business environment).

This product is a measurement category II (CAT II) instrument.

* Measurement category II (CAT II)

Applies to measuring circuits connected to low voltage installation, and electrical instruments supplied with power from fixed equipment such as electric switchboards.

The following general safety precautions must be observed during all phases of operation. If the DX100L is used in a manner not specified in this manual, the protection provided by the DX100L may be impaired. YOKOGAWA Electric Corporation assumes no liability for the customer's failure to comply with these requirements.

Please use this instrument as a measurement category II (CAT II) instrument.

This instrument is for indoor use only.

The following symbols are used on the DX100L.



"Handle with care." To avoid injury, death of personnel or damage to the instrument, the operator must refer to the explanation in the User's Manual or Service Manual.



High temperature : To avoid injury caused by hot surface, do not touch the heat sink.



Functional ground terminal. Do not use this terminal as a protective ground terminal.



Protective ground terminal.



AC



ON (power)



OFF (power)

Exemption from Responsibility

- YOKOGAWA makes no warranties regarding the product except those stated in the WARRANTY that is provided separately.
- YOKOGAWA assumes no liability to any party for any loss or damage, direct or indirect, caused by the user or any unpredictable defect of the product.

Handling Precautions of the Software

- YOKOGAWA makes no warranties regarding the software accompanying this product except those stated in the WARRANTY that is provided separately.
- Use the software on a single PC.
- You must purchase another copy of the software, if you are to use the software on another PC.
- Copying the software for any purposes other than backup is strictly prohibited.
- Please store the original media containing the software in a safe place.
- Reverse engineering, such as decompiling of the software, is strictly prohibited.
- No portion of the software supplied by YOKOGAWA may be transferred, exchanged, or sublet or leased for use by any third party without prior permission by YOKOGAWA.

Make sure to comply with the following safety precautions. Failure to comply may result in injury or death (electric shock hazard).

WARNING

Power Supply

Ensure that the source voltage matches the voltage of the power supply before turning ON the power.

Protective Grounding

Make sure to connect the protective grounding to prevent electric shock before turning ON the power.

Necessity of Protective Grounding

Never cut off the internal or external protective grounding wire or disconnect the wiring of the protective grounding terminal. Doing so poses a potential shock hazard.

Defect of Protective Grounding

Do not operate the instrument when the protective grounding or the fuse might be defective. Also, make sure to check them before operation.

Fuse

To prevent fire, only use a fuse that has a rating (voltage, current, and type) that is specified by the instrument. When replacing a fuse, turn OFF the power switch and unplug the power cord. Never short the fuse holder.

Do Not Operate in Explosive Atmosphere

Do not operate the instrument in the presence of flammable liquids or vapors. Operation of any electrical instrument in such an environment constitutes a safety hazard.

Do Not Remove Covers

Some areas inside the instrument have high voltages. Do not remove the cover if the power supply is connected. The cover should be removed by YOKOGAWA's qualified personnel only.

External Connection

Connect the protective grounding before connecting to the item under measurement or control unit.

Damage to the protection

Using the instrument in a manner not specified in this manual can damage the instrument's protection.

CAUTION

This instrument is a Class A product. Operation of this instrument in a residential area may cause radio interference, in which case the user is required to take appropriate measures to correct the interference.

Checking the Contents of the Package

Unpack the box and check the contents before operating the DX100L. If some of the contents are not correct or missing or if there is physical damage, contact the dealer from which you purchased them.

DX100L Main Unit

There is a name plate on the back side of the key panel cover. Open the cover and check that the model name and suffix code given on the name plate match those on the order.

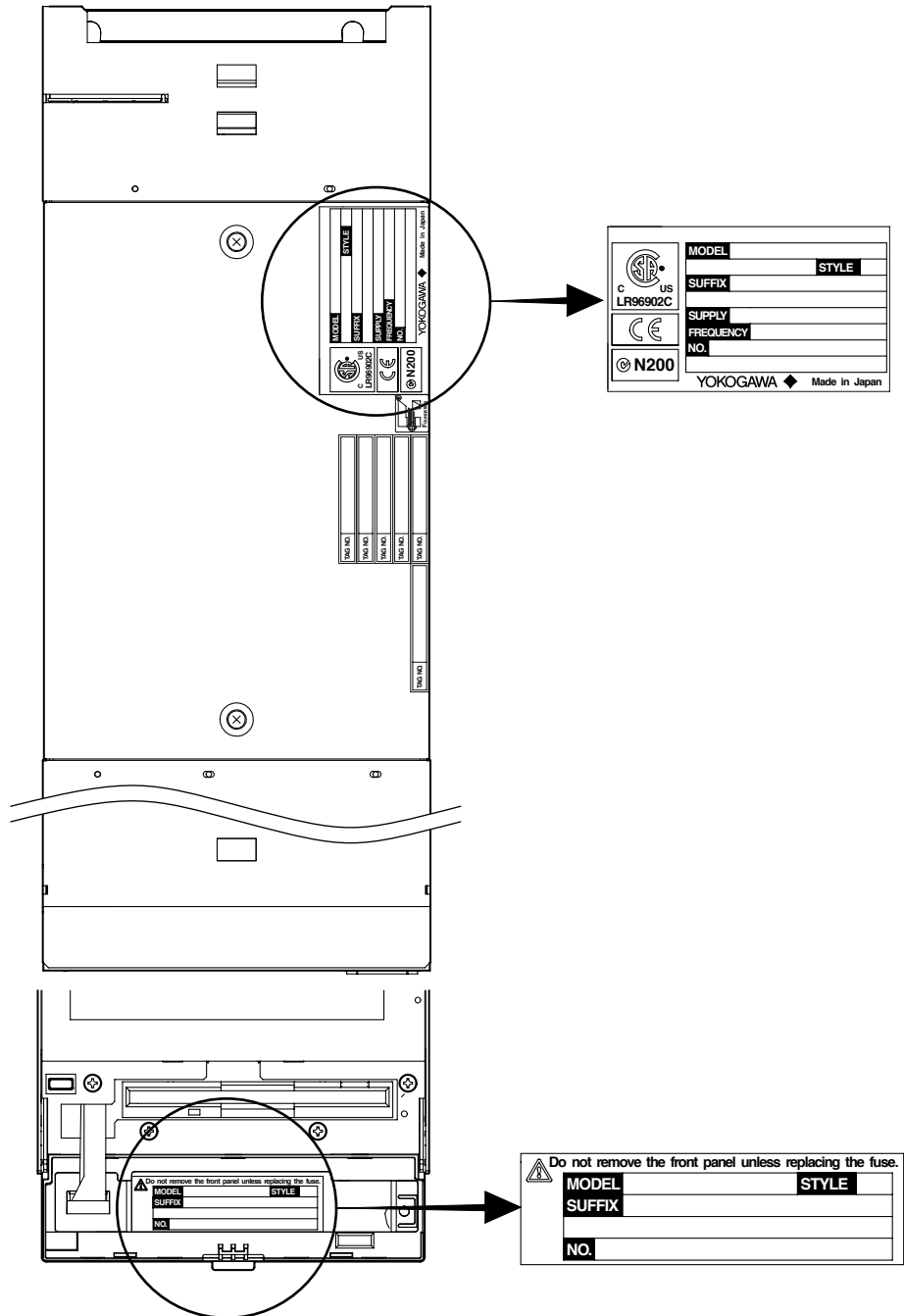

Checking the Contents of the Package

MODEL

Model code	Suffix code	Optional code	Description
DX102L			DAQSTATION DX100L (2 ch)
DX104L			DAQSTATION DX100L (4 ch)
DX106L			DAQSTATION DX100L (6 ch)
DX112L			DAQSTATION DX100L (12 ch)
Housing type	-1		For foxboro Spec 200 (except single shelf)
	-2		For μ R-F/SRHD
	-3		For NRE/SRHD
External storage medium	-1		Floppy disk
	-2		100 MB Zip disk ^{*10}
	-3		ATA flash memory card
	-5		250 MB Zip disk ^{*10}
Language		-2	English, deg.F/DST (DAQSTANDARD Software included)
Options		/AR1	Alarm output relay (2 relays)/remote control ^{*1}
		/AR2	Alarm output relay (4 relays)/remote control ^{*1}
		/A3	Alarm output relay (6 relays) ^{*1}
		/BT1	Batch function
		/C2	RS-232 interface ^{*2}
		/C3	RS-422/485 interface ^{*2}
		/CF1	Fieldbus Communication Interface ^{*2,7}
		/F1	FAIL/memory end output relay ^{*3}
		/H2	Clamped input terminal
		/H6	Mounting keit for single panel mounting ^{*4}
		/H7	Bezel color: Mansell 7.5BG4/1.5 ^{*5}
		/M1	mathematical function (with report function)
		/N1	Cu10, Cu25 RTD input/3 terminal isolated RTD
		/N2	3 terminal isolated RTD ^{*6}
		/P1	24 VDC/AC power supply
		/R1	Remote control
	/TPS2	24 VDC Power supply for transmitter(2 loops) ^{*8}	
	/TPS4	24 VDC Power supply for transmitter(4 loops) ^{*9}	

- *1 /AR1, /AR2 and /A3 cannot be specified simultaneously.
 *2 /C2, /C3 and /CF1 may not be specified together.
 *3 If /F1 is specified, /A3 cannot be specified.
 *4 /H6 can only be specified on DX1□□-2-□-□/□, and DX1□□-3-□-□/□ models
 *5 /H6 must be specified with this option.
 *6 /N2 can only be specified on DX106L, and DX112L models
 *7 If /CF1 is specified, make sure to specify /M1.
 *8 If /TPS2 is specified, /TPS4, /A2, /A3 and /F1 cannot be specified.
 *9 If /TPS4 is specified, /TPS2, /A1, /A2, /A3 and /F1 cannot be specified.
 *10 This product is no longer produced.

NO. (Serial No.)

When contacting the dealer from which you purchased the DX100L, please quote the serial No.

Standard Accessories

The following standard accessories are supplied with the DX100L. Make sure that all items are present and undamaged.

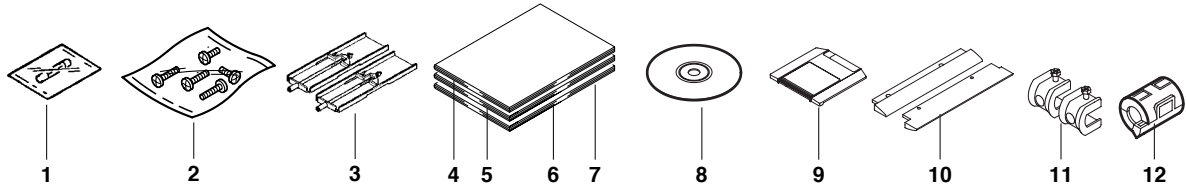

Number	Part Name	Part Number/Model	Q'ty	Notes
1	Fuse	A1347EF	1	250 V 1 A, time lag (except for /P1 model)
		A1352EF	1	250 V 4 A, time lag (for /P1 model)
2	Terminal screw		5	M4
3	Mounting bracket	E9710CM	2	Included only when the suffix code for the housing type is "-2."
		E9710CT	1	Included only when the suffix code for the housing type is "-3."
4	User's Manual	IM 04L04A01-01E	1	This manual
5	User's Manual	IM 04L02A01-17E	1	DX100/DX200 Communication Interface
6	User's Manual	IM 04L02A01-61E	1	DAQSTANDARD Software
7	User's Manual	IM 04L02A01-18E	1	Fieldbus Communication Interface. Provided only when "/CF1" is specified for the optional code.
8	DAQSTANDARD	DXA120	1	CD-ROM containing the DAQSTANDARD.
9	External storage medium	A1053MP	1	Zip disk, included only when the suffix code for external storage medium is "-2."
		A1056MP	1	250 MB Zip disk, included only when the medium suffix code for external storage medium is "-5."
		B9968NL	1	ATA flash memory card (32-MB CF card + adapter, capacity and model of the CF card may vary) included only when the suffix code for the external storage medium is "-3."
10	Frame	B9910HX	1	Included only when the suffix code for option is "/H6."
		B9910HW	1	Included only when the suffix code for option is "/H6."
		B9910HY	1	Included only when the suffix code for option is "/H7."
		B9910HZ	1	Included only when the suffix code for option is "/H7."
11	Vise	E9310DT	1	Included only when the suffix code for Housing type is "-3."
12	Clamp filter	A1179MN		Provided only when "/CF1" is specified for the optional code.

Checking the Contents of the Package

Optional Accessories (Sold Separately)

The following optional accessories are available for purchase separately. If you make an order, make sure that all items are present and undamaged.

For information about ordering accessories, contact the dealer from which you purchased the DX100L.

Number	Part Name	Part Number/Model	Q'ty	Notes
1	3.5" floppy disk	7059 00	10	2HD
2	Zip disk	A1053MP	1	100 MB
		A1056MP	1	250 MB
3	ATA flash memory card (CF card + adapter)	B9968NL	1	32-MB card (capacity and model of the CF card may vary, please be careful when ordering)
4	Shunt resistor (for the screw terminal)	4159 20	1	250 Ω \pm 0.1%
		4159 21	1	100 Ω \pm 0.1%
		4159 22	1	10 Ω \pm 0.1%
5	Shunt resistor (for the clamped input terminal)	4389 20	1	250 Ω \pm 0.1%
		4389 21	1	100 Ω \pm 0.1%
		4389 22	1	10 Ω \pm 0.1%
6	Fuse	A1347EF	4	250 V 1 A time lag (except for /P1 model)
		A1352EF	4	250 V 4 A, time lag (for / P1 model)
7	Mounting bracket	E9710CM	2	
		E9710CT	1	

Software (Sold Separately)

The following software application is available:

Name	Model
DAQEXPLORER	WX104

How to Use this Manual

Structure of the Manual

This user's manual consists of the following sections:

For information about the communication functions, the fieldbus function, and the DAQSTANDARD, see the respective manuals (IM 04L02A01-17E, IM 04L02A01-18E, and IM 04L41B01-61E).

Chapter	Title and Contents
1	Overview of Functions Describes the functions of the DX100L.
2	Before Using the DX100 Describes the installation and wiring procedures.
3	Names of Parts/Run Mode/Common Operations Describes the names of each part of the DX100L, how to use the storage medium drive, run mode, and common key operations.
4	Switching Operation Screens Describes how to use the operation screen such as the trend display and digital display. Describes the operations that can be performed using the arrow keys and the DISP/ENTER key on the front panel.
5	Input Channel Settings Describes how to set input specifications such as the range, filter, moving average, scan interval, integration time of the A/D converter, burnout, and reference junction compensation.
6	Acknowledging and Setting Alarms Describes how to acknowledge alarms and how to set alarms.
7	Setting and Operating the Display Describes how to set the display specification of the operation screen, how to display messages, and other display-related operations.
8	Data acquisition and Saving to External Storage Medium Describes how to acquire the measured/computed data and how to save the data to the external storage medium.
9	Managing Files and Initializing Data Describes how to save and load the setup data, manage files on the external storage medium, save the data residing in the internal memory to the external storage medium using key operations, initialize the internal memory, and other operations.
10	Other Functions Describes how to set and operate key lock, key login/logout, user key, and other functions.
11	Computation/Report Function (Option) Describes how to use the optional computation (report) function.
12	Troubleshooting Describes the error messages and the troubleshooting measures of the DX100L.
13	Maintenance Describes fuse replacement and other information.
14	Specifications Describes the specifications of the DX100L.
Appendix	Describes the initial values of the setting mode and basic setting mode, file formats of ASCII files.
Index	

Note

This manual covers information regarding DX100Ls that have a suffix code for language “-2” (English).

Conventions Used in this Manual

Unit

K Denotes “1024.” Example: 768 KB (File capacity)

k Denotes “1000.”

M Denotes “1024K.” Example: 1.44 MB (Storage capacity of floppy disks)

B “Bytes.” Example: 1.44 MB (Storage capacity of floppy disks)

Symbols

The following symbols are used in this manual.



Affixed to the instrument. Indicates danger to personnel or instrument and the operator must refer to the User’s Manual. The symbol is used in the User’s Manual to indicate the reference.



Describes precautions that should be observed to prevent injury or death to the user.



Describes precautions that should be observed to prevent minor or moderate injury, or damage to the instrument.

Note

Provides important information for the proper operation of the instrument.

Notation regarding procedures

On pages that describe the operating procedures in Chapter 3 through 11, the following symbols are used to distinguish the procedures from their explanations.

[] Represents contents that are displayed on the screen. Example: [Volt]

⇒ “ ” Indicates a reference item. Example: ⇒ “1.3 Display Function”

#1

 to

#12

 Denotes the soft key that is used to make a selection on the setting and basic setting menus.



Follow the steps indicated with numbers. The procedures are given with the premise that the user is carrying out the steps for the first time. Depending on the operation, not all steps need to be taken.



This section describes the setting parameters and the limitations regarding the procedures. It does not give a detailed explanation of the function. For detail on the function, see chapter 1.

Revision History

Edition	Addition and change to functions
3	Added explanations. Fixed explanations.

Contents

Foreword	i
Safety Precautions	iii
Checking the Contents of the Package	v
How to Use this Manual	ix
Chapter 1 Overview of Functions	
1.1 Overview of the DX100L	1-1
1.2 Functions of the Input Section	1-2
1.3 Display Function	1-5
1.4 Storage Function	1-15
1.5 Alarm Function	1-17
1.6 Computation Function and Report Function (/M1 Option)	1-20
1.7 Batch Function (/BT1 Option)	1-22
1.8 Other Functions	1-24
Chapter 2 Before Using the DX100L	
2.1 Precautions on the Use of the DX100L	2-1
2.2 Installing the DX100L	2-3
2.3 Input Signal Wiring	2-5
2.4 Alarm Output Wiring (/AR1, /AR2, /A3 Option)	2-9
2.5 FAIL/Memory End Wiring (/F1 Option)	2-11
2.6 Remote Control Wiring (/R1 Option)	2-13
2.7 24 VDC Transmitter Power Supply Wiring (/TPS2, /TPS4, Option)	2-15
2.8 Power Supply Wiring	2-17
Chapter 3 Names of Parts/Run Mode/Common Operations	
3.1 Names of Parts and Functions	3-1
3.2 Turning ON/OFF the Power Switch	3-4
3.3 Inserting/Removing the External Storage Medium	3-5
3.4 Run Mode	3-7
3.5 Configuring the Functions (Setting Mode and Basic Setting Mode)	3-10
3.6 Common Key Operations	3-19
3.7 Setting the Date and Time	3-23
Chapter 4 Switching Operation Screens	
4.1 Operation Screens	4-1
4.2 Explanation of the Status Display Section	4-2
4.3 Using the Trend, Digital, and Bar Graph Screens	4-5
4.4 Using the Overview Screen	4-11
4.5 Using the Information Screen (Alarm Summary, Message Summary, and Memory Summary)	4-13
4.6 Using the Historical Trend	4-18

1

2

3

4

5

6

7

8

9

10

11

12

13

14

App

Index

Chapter 5 Measurement Channel Settings

5.1	Voltage Input Setting	5-1
5.2	Thermocouple (TC)/Resistance Temperature Detector (RTD) Setting	5-3
5.3	Digital Input (DI) Setting	5-5
5.4	Difference Computation (Delta) Setting	5-7
5.5	Scaling Setting	5-9
5.6	Square Root Computation Setting	5-11
5.7	Skip Setting	5-13
5.8	Input Filter and Moving Average Setting	5-14
5.9	Setting the A/D Integration Time, Scan Interval, Burnout, and Reference Junction Compensation (Basic Setting Mode)	5-15

Chapter 6 Acknowledging and Setting Alarms

6.1	Releasing the Alarm Indication and Output Relay (Option)	6-1
6.2	Alarm Setting	6-5
6.3	Setting the Alarm Delay Period	6-8
6.4	Setting the Auxiliary Alarm Function (Basic Setting Mode)	6-10

Chapter 7 Setting and Operating the Display

7.1	Setting Tag Names	7-1
7.2	Selecting Tag Display or Channel Number Display (Basic Setting Mode)	7-2
7.3	Setting the Display Update Rate (Trend)	7-3
7.4	Using Message Strings (Trend)	7-4
7.5	Setting the Message String (Trend)	7-7
7.6	Setting Groups	7-8
7.7	Setting the Trip Line (Trend)	7-10
7.8	Setting the Channel Display Colors (Trend, Bar Graph)	7-12
7.9	Using Zone Displays (Trend)	7-13
7.10	Setting the Scale Division, Bar Graph Base Position (Bar Graph), and Scale Position (Trend)	7-15
7.11	Using Partial Expanded Display (Trend)	7-20
7.12	Setting Whether or Not to Use the Partial Expanded Display (Basic Setting Mode)	7-22
7.13	Setting the Display Direction, Background Color, Waveform Line Width, Trip Line Width, Grid, Scroll Time, and Scale digit	7-23
7.14	Setting the Brightness of the Screen and the Backlight Saver Function	7-25

Chapter 8 Data Acquisition and Saving to External Storage Medium

8.1	Data Types to be Acquired and Saved	8-1
8.2	Function to Acquire Display Data and Event Data	8-3
8.3	Function to Acquire Other Data	8-9
8.4	Function that Saves the Data in the Internal Memory to the External Storage Medium	8-10
8.5	Acquiring Display Data	8-12
8.6	Acquiring Event Data	8-13
8.7	Saving the Data in the Internal Memory to the External Storage Medium	8-15
8.8	Setting the Auto Save Interval for the Display Data	8-18
8.9	Setting the File Header, Directory Name, and the Saved Data during Manual Save	8-20
8.10	Setting the Channels to Display the Trend and Acquire the Data (Basic Setting Mode)	8-22
8.11	Setting the Method of the Display/Event Data Acquisition (Basic Setting Mode)	8-23
8.12	Specifying the Date/Time When Data Is To Be Saved to the External Storage Medium (Basic Setting Mode)	8-26
8.13	Storing Measured/Computed Data at Arbitrary Times (Manual Sampling)	8-28

Chapter 9 Managing Files and Initializing Data

9.1 Saving/loading setup data 9-1

9.2 Saving data in the internal memory to the external storage medium using key operation 9-5

9.3 Viewing Display Data in the External Storage Medium 9-6

9.4 Viewing Event Data in the External Storage Medium 9-7

9.5 Managing files/Displaying free space on the external storage medium 9-8

9.6 Saving the Screen Image 9-13

9.7 Clearing Data from the Internal Memory 9-14

9.8 Initializing Setup Data 9-15

Chapter 10 Other Functions

10.1 USER Key 10-1

10.2 Assigning an Action to the USER Key 10-2

10.3 Using Key Lock 10-3

10.4 Setting the Key Lock Function (Basic Setting Mode) 10-4

10.5 Using the Key Login/Logout Function 10-6

10.6 Setting the Key Login/Logout Functions (Basic Setting Mode) 10-8

10.7 Displaying the Log Screen/System Screen 10-10

10.8 Setting the Memory Alarm Time (/F1 Option Provides an Relay Output Alarm, Basic Setting Mode) 10-12

10.9 Setting the Remote Control Functions (/R1 Option, Basic Setting Mode) 10-13

10.10 Setting the Displayed Language (Basic Setting Mode) 10-16

10.11 Checking or Changing Batch/Lot Numbers and Entering or Changing Comments (/BT1 Option) 10-17

10.12 Setting the Batch Information (/BT1 Option) 10-19

10.13 Setting Whether or Not to Use the Batch Function (/BT1 Option, Basic Setting Mode) 10-21

10.14 Using the Daylight Savings Time Adjustment Function 10-22

10.15 Setting the Temperature Unit (Basic Setting Mode) 10-24

10.16 Setting the Time Zone (Basic Setting Mode) 10-25

Chapter 11 Computation/Report Function (Option)

11.1 Overview of the Computation Function 11-1

11.2 Explanation of Computing Equations 11-4

11.3 Using the Computation Function 11-8

11.4 Setting Computation Channels 11-10

11.5 Setting the Alarm 11-12

11.6 Setting Constants 11-14

11.7 TLOG Computation 11-15

11.8 Setting the Timer Number and Sum Scale for TLOG Computation 11-17

11.9 Setting the Timer (Basic Setting Mode) 11-18

11.10 Using the Rolling Average 11-20

11.11 Overview of the Report Function 11-22

11.12 Using the Report Function 11-25

11.13 Setting the Report Function (Basic Setting Mode) 11-26

Chapter 12 Troubleshooting

12.1 A List of Messages 12-1

12.2 Troubleshooting Flow Chart 12-9

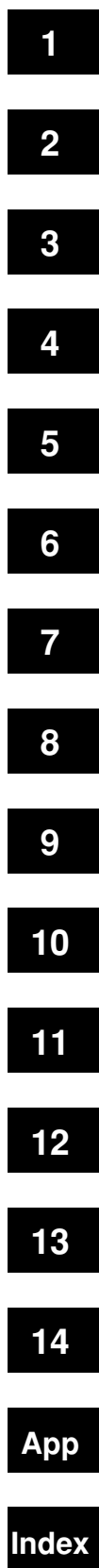

Chapter 13 Maintenance

13.1 Periodic Maintenance 13-1
13.2 Replacing the Fuse 13-2
13.3 Calibration 13-3
13.4 Recommended Replacement Periods for Worn Parts 13-5

Chapter 14 Specifications

14.1 Input Specifications 14-1
14.2 Display Specifications 14-3
14.3 Data Storage Specifications 14-5
14.4 Alarm Function Specifications 14-8
14.5 Specifications of Communication Functions 14-9
14.6 Specifications of Optional Functions 14-10
14.7 General Specifications 14-14
14.8 Dimensional Drawings 14-19

Appendix

Appendix 1 Parameters and Initial Settings App-1
Appendix 2 Data Formats of ASCII Files App-9
Appendix 3 The Relationship between Style Numbers and Functions App-14

Index

1.1 Overview of the DX100L

Unlike conventional recorders that record data on charts, the DX100L displays the measured data acquired in the internal memory to a LCD in the form of waveforms, numerical values, and bar graphs. The measured data can also be saved to external storage media such as floppy disks, Zip disks, and ATA flash memory cards.

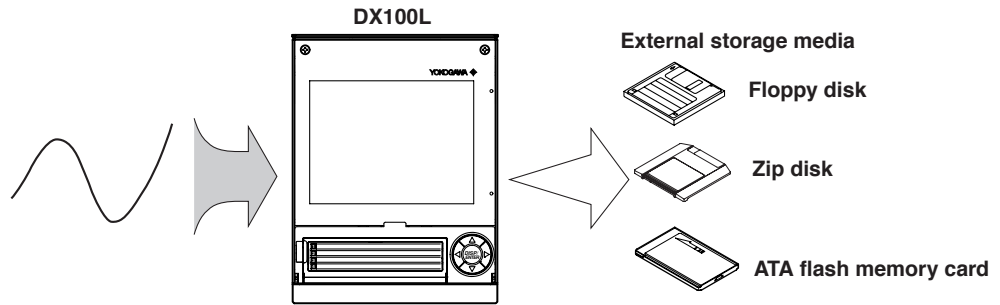

The data that have been saved to an external storage medium can be displayed on a PC using the standard software that comes with the package. The data can also be loaded into the DX100L to be displayed.

By using the Ethernet interface that comes standard with the DX100L, the data can be transferred to a server on a network (client function). The data stored on the DX100L's external storage medium can also be read from a PC on the network (server function).

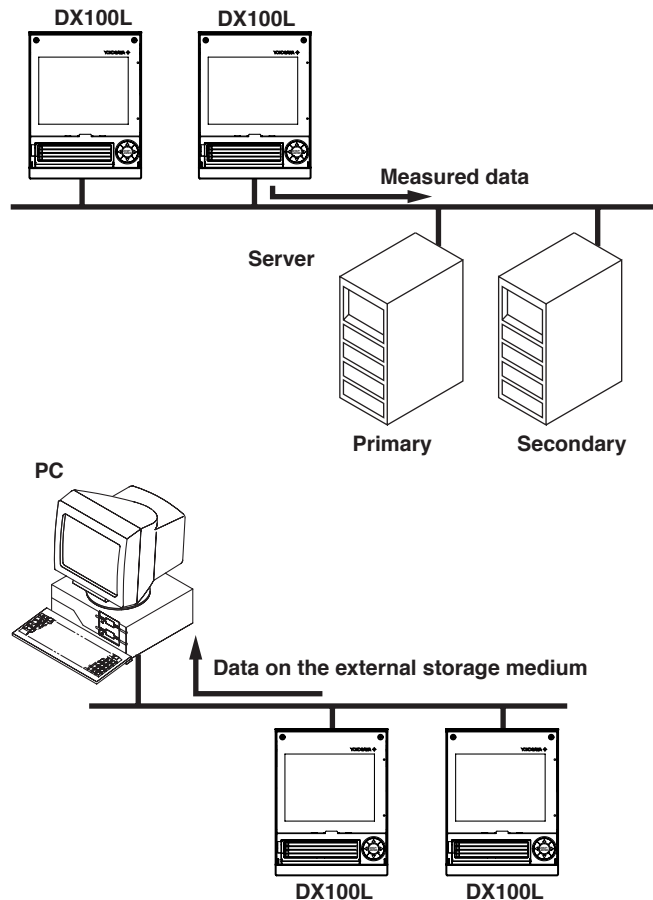

This manual does not cover the communication functions using the Ethernet network or serial interface. See the DX100/DX200 Communication Interface User's Manual (IM 04L02A01-17E).

1.2 Functions of the Input Section

Number of Measurement Channels/Scan Interval

The number of measurement channels and scan intervals for different models are listed in the table below. For the procedure related to setting the scan interval, see section 5.9.

Model	Number of Measurement Channels	Scan interval
DX102L	2 channels	125 ms or 250 ms
DX104L	4 channels	125 ms or 250 ms
DX106L	6 channels	1 s or 2 s
DX112L	12 channels	1 s or 2 s

Input Type and Computation

You can select the input type of a measurement channel from DC voltage, thermocouple, resistance temperature detector (RTD), and digital input (contact signal or voltage signal). You can also perform computation on the measured data such as the “difference,” “square root,” and “scaling.”

The input type and computation are configured as an “input mode” on the DX100L. For the procedure related to setting the different modes, see sections 5.1 to 5.7.

Input Mode	Notation* ¹	Description
DC voltage	Volt	Measures a DC voltage in the range ± 20 mV to ± 50 V.
Thermocouple	TC	Measures the temperature corresponding to the appropriate range for R, S, B, K, E, J, T, N, W, L, and U.
Resistance temperature detector	RTD	Measures the temperature corresponding to the appropriate range for Pt100, JPt100, Cu10* ² , and CU25* ² .
Digital input	DI	Displays the contact input or voltage input signals by correlating them to 0% or 100% of the display range. Contact input: Closed contact is “1.” Open contact is “0.” Voltage input: Less than 2.4 V is “0.” Greater than or equal to 2.4 V is “1.”
Difference	Delta	When the input type* ³ is set to “DC voltage,” “thermocouple,” “RTD,” or “digital input,” the value obtained by subtracting the measured value of another channel (this channel is called a “reference channel”) from the input signal of the channel set to compute the difference is displayed as the measured value of that channel.
Square root	Sqrt	When the input type* ³ is set to “DC voltage,” the square root of the input signal of the channel set to compute the square root is displayed as the measured value of that channel. The computed result can be scaled to a value in the appropriate unit and displayed.
Scaling	Scale	When the input type* ³ is set to “DC voltage,” “thermocouple,” “RTD,” or “digital input,” the input signal can be converted to a value in the appropriate unit desired and displayed.
Skip	Skip	Channels that are not measured. They are not displayed.

*1 Notation used by the DX100L to represent the input modes. It is used when setting the measurement channels.

*2 This is optional.

*3 This item defines the type of signals that can be connected to the input terminal when the input mode is set to “Difference,” “Square root,” or “Scaling.” The description of the input types, “DC voltage,” “Thermocouple,” “Resistive temperature detector,” and “digital input,” are the same as the descriptions given for the input modes, “DC voltage,” “Thermocouple,” “Resistive temperature detector,” and “digital input,” respectively.

If the signal to be measured is a DC current, a shunt resistor is attached to the input terminal to convert the current signal to a voltage signal. The input mode is set to “DC voltage” in this case. For the various types of shunt resistors and the procedure related to setting the current input, see section 5.1.

Input Range and Measurable Range

You can select the “Input range” that is appropriate for the input signal for “DC voltage,” “Thermocouple,” “RTD,” and “digital input.” (For example, R, S, B, K, E, J, T, N, W, L, and U are available input ranges for “Thermocouple.”) For each “Input range,” a measurable range is defined (for example, the measurable range for /R of “Thermocouple” is “0.0 °C to 1760 °C”). For details, see section 14.1.

Burnout

When measuring temperature using a thermocouple and the thermocouple burns out, you can specify the measurement result to be set to positive over range*¹ or negative over range.*² Burnout can be set on each measurement channel. The initial setting is set so that burnout is not indicated. For the setting procedure, see section 5.9.

*1 Positive over range is a condition in which the input signal is over the upper limit of the measurable range. The measured value is indicated as “+*****.”

*2 Negative over range is a condition in which the input signal is below the lower limit of the measurable range. The measured value is indicated as “-*****.”

Reference junction compensation (RJC)

When measuring the temperature using a thermocouple, the reference junction compensation can be used. You can select whether to use the reference junction compensation provided by the DX100L or external reference junction compensation. If you are using external reference junction compensation, you will also set the reference voltage. The initial setting is set so that the reference junction compensation provided by the DX100L is used. For the setting procedure, see section 5.9.

Filter and Moving Average

The filter and moving average are used to suppress the effects of noise that is riding on the signal. Filtering is provided on the DX102L and DX104L. Moving average is provided on the DX106L, and DX112L. The filter or moving average can be set on each channel. For the setting procedure, see section 5.8.

Filter Function (DX102L and DX104L)

Suppresses the effects of noise above the frequency determined by the specified time constant. The time constant can be set to 2 s, 5 s, or 10 s. The filter is initially turned OFF.

Effects of using filter(Output response for a step input)

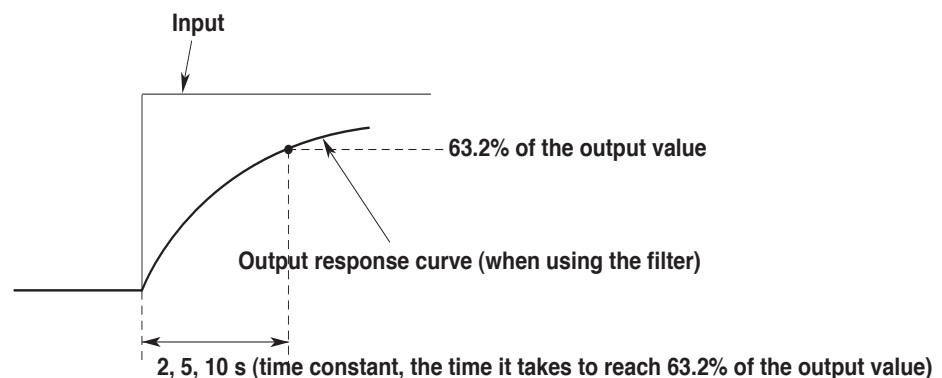

1.2 Functions of the Input Section

Moving Average (DX106L, and DX112L)

The input signal of the measurement channel is set to the averaged value of the m most current data points (the number of moving-averaged data points) acquired at the scan interval. The number of moving-averaged data points can be set in the range 2 to 16. The moving average is initially turned OFF.

The figure below shows an example indicating the operation of the buffer for the moving average computation when the number of moving averaged data points is set to “5.”

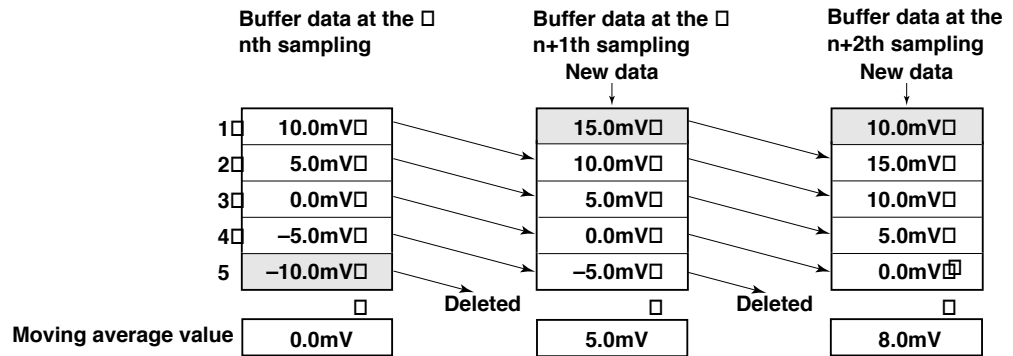

Integration Time of the A/D Converter

The DX100L uses an A/D converter to convert the sampled analog signal to a digital signal. By setting the integration time to match the time period corresponding to one cycle of the power supply or an integer multiple of one cycle, the power supply frequency noise can be effectively eliminated.

The integration time of the A/D converter is selected according to the model from the table below. If “Auto” is selected, the DX100L will automatically detect the power supply frequency and select 16.7 ms or 20 ms. Because 100 ms is an integer multiple of 16.7 ms and 20 ms, this setting can be used to eliminate the power frequency noise for either frequency, 50 Hz or 60 Hz. 100 ms is available on the DX106L, and DX112L. However, when the integration time is 100 ms, the scan interval is fixed to 2 s. For the setting procedure, see section 5.9.

Model	Integration Time of the A/D Converter
DX102L/DX104L	Select 16.7 ms (60 Hz), 20 ms (50 Hz), or auto (Automatically switches between 16.7 ms and 20 ms. Fixed to 20 ms on /P1 models that use the 24 VDC power supply.)
DX106L/DX112L	Select 16.7 ms (60 Hz), 20 ms (50 Hz), 100 ms, or auto (Automatically switches between 16.7 ms and 20 ms. Fixed to 20 ms on /P1 models that use the 24 VDC power supply.)

1.3 Display Function

Common Items Related to the Display

5.5" TFT Color LCD and the Screen Configuration

The DX100L has a 5.5" TFT color LCD (240-by-320 dot resolution). The screen consists of the status display section and the data display section.

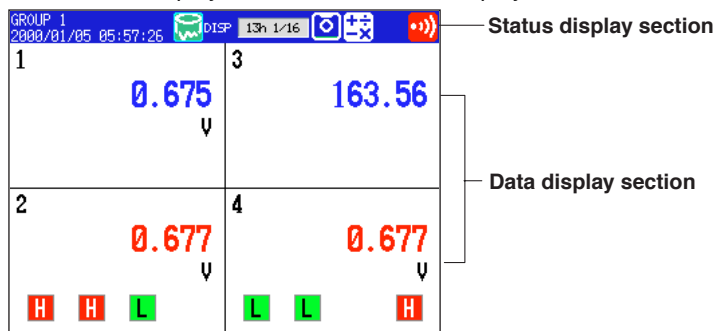

Status Display Section

Displays the displayed screen name, date and time or batch name (batch name is for / BT1 option only), internal memory/external storage medium usage condition, alarm condition, key lock, user name (key login function), and computation condition (option). For details, see section 4.2.

Data Display Section

- Displays the operation screen such as the trend display, digital display, and bar graph display of the measured and computed data as well as alarm, message, and file information.
- Displays the setup screen for the setting and basic setting modes when the DX100L is being configured. For details related to the setting and basic setting modes, see section 3.5.

Group Display

The data displayed on the trend, digital, and bar graph displays are the data of measurement or computation channels that are assigned to the group. Up to 6 channels can be assigned to a single group. For the procedure used to assign channels to groups, see section 7.6, "Setting Groups." Up to four groups can be registered. The groups are common to the trend, digital, and bar graph displays.

On the trend, digital, and bar graph displays, the displayed groups can be automatically switched at 5 s, 10 s, 20 s, 30 s, or 1 min intervals.

Channel Number of Tag Display

The channels can be displayed as channel number or tags. The setting applies to all channels. For the procedure related to the selecting the channel display or tag display, see section 7.2. For the procedure related to setting the tags, see section 7.1.

1.3 Display Function

Trend Screen

Displays the waveform of the measured and computed data. The direction of the waveform display can be set to horizontal or vertical. For details related to the display method, see section 4.3.

Trend Display (Vertical)

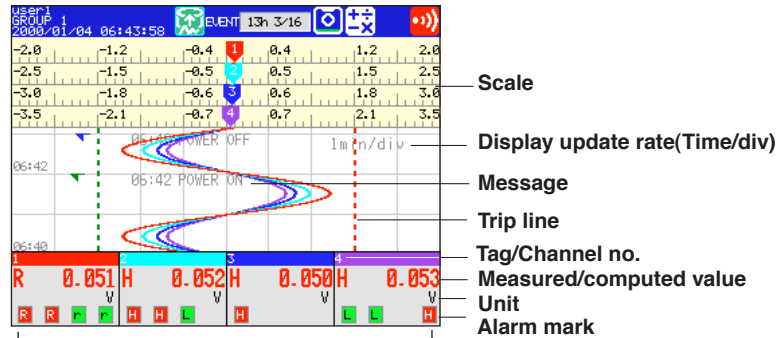

Numerical display section

Trend Display (Vertical, All channels)

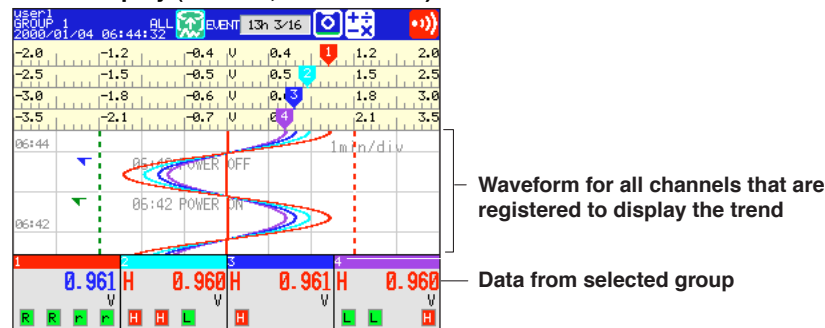

Trend Display (Horizontal, Type 1)

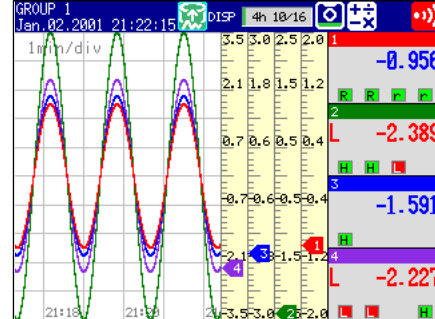

Trend Display (Horizontal, Type 2)

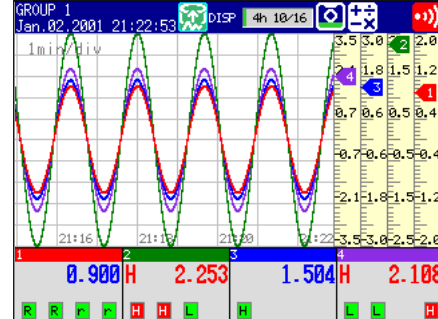

Updating the Waveform and Updating the Numerical Display

One division along the time axis consists of 30 dots on the LCD. The displayed waveform is updated at an interval corresponding to one dot. This interval is determined by the time period corresponding to one division (referred to as the display update rate). The relationship between the display update rate and the speed of movement of waveforms is as follows:

Display Update Rate (div)	15 s*	30 s*	1 min	2 min	5 min	10 min	20 min	30 min	1 h	2 h	4 h	10 h
Speed of movement of waveform (approximate value, mm/h)	2376	1188	594	297	119	59	30	20	10	5	2.5	1.0

* for DX102L and DX104L only

Note

The speed of movement of the trend display along the time axis is derived from the following equation given the dot pitch of the LCD (0.33 mm):

$$\text{The speed of movement of the trend display along the time axis} = 30 \text{ (dots)} \times 0.33 \text{ (mm)} \times 60 \text{ (min)/display update rate (min)}$$

Measured/computed values are updated every second. However, when the scan interval on the DX106L/DX112L is 2 s, the display update rate is also 2 s.

Displayed Data

The data displayed on the screen are a maximum and minimum values of the data that are sampled at the scan interval, within the time period corresponding to one dot.

Displayed data of the waveform (when the display update rate is set to one minute)

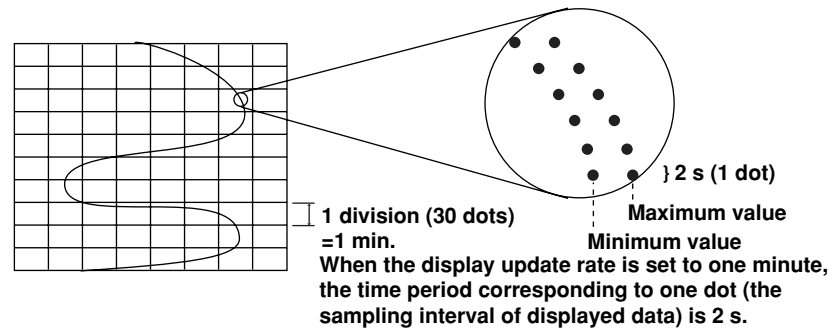

The time period corresponding to one dot is called “the sampling interval of displayed data.” The sampling interval of displayed data is determined by the display update rate. The relationship between the display update rate and the sampling interval of displayed data is as follows:

Display Update Rate (/div)	15 s*	30 s*	1 min	2 min	5 min	10 min	20 min	30 min	1 h	2 h	4 h	10 h
Sampling interval of displayed data (s)	0.5	1	2	4	10	20	40	60	120	240	480	1200

* for DX102L and DX104L only

For the procedure related to setting the display update rate, see section 7.3.

Displayed Information

The following Information can be displayed.

Information	Description
All channel display	Waveforms of all the channels that were set to display the trend are displayed on one trend screen. ⇒“Sections 4.3 and 8.10”
Message display	Messages specified by the user can be displayed at arbitrary points in time. For example, by displaying a message when a certain operation is carried out, the point at which the operation is carried out can be seen visually. Displayed messages are stored. ⇒“Sections 7.4 and 7.5”
Display direction of waveforms	The waveform can be displayed vertically or horizontally. The vertical display is in the same direction as the chart recorder and is convenient when the DX100L is used with the chart recorder. ⇒“Section 7.13”
Displayed color of waveforms	The displayed color of waveforms can be specified for each channel. The color also applies to the bar graph display. ⇒“Section 7.8”
Thickness of waveform lines	You can select from three types: 1, 2, or 3 dots. The specified thickness of waveform lines applies to all channels. ⇒“Section 7.13”
Trip line display	Displays a line to indicate a particular value of interest (trip line) for each group. You can select the thickness of the displayed line from three types: 1, 2, or 3 dots. Up to four trip lines can be displayed on a single group. ⇒“Sections 7.7 and 7.13”

1.3 Display Function

Scale display	A scale appropriate for the measured item can be displayed for each channel. The number of divisions of the display scale created by the main scale marks can be set to a value in the range 4 to 12 div (also applies to the bar graph display). Medium and small scale marks are displayed in between the main scale marks. You can select whether or not to display the scale for each channel and the display position. ⇒“Section 7.10”
Turn ON/OFF the numerical display section	The numerical display section can be turned ON or OFF. If the numerical display section is turned OFF, the display shows only the waveform and the scale. See section 4.3.
Zone display	The waveform of each channel is displayed in its display range (zone). The waveforms are easier to view, because they do not overlap. See the explanation of the zone display below. ⇒“Section 7.9”
Partial expanded display	You can expand the important section of the display range. See the explanation of the partial expanded display below. ⇒“Sections 7.11 and 7.12”

Explanation Regarding the Zone Display

The display range of the waveform is called a zone. Zones can be set for each channel. The waveforms can be set in different zones, so that they are easier to view. In the example shown in the figure below, channel 1 is displayed in the zone 0 to 30%, channel 2 in the zone 30 to 60%, and channel 3 in the zone 60 to 100%.

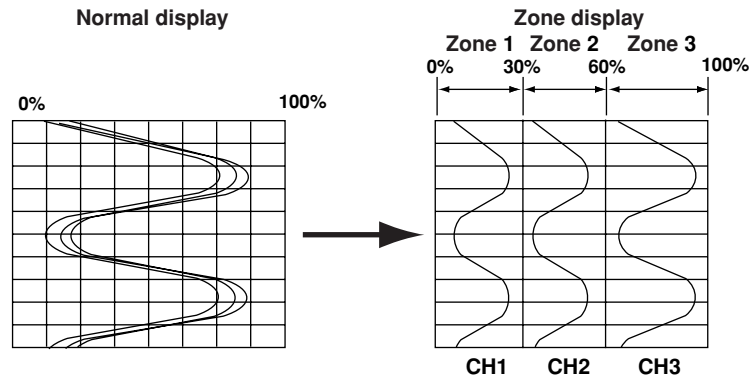

Explanation Regarding the Partial Expanded Display

By compressing a section of the display scale of the waveform, the remaining section of the display is expanded. You specify a value on the display scale (boundary value) to be moved to another position on the display scale (boundary value displacement position). In the example shown in the figure below, 0 V (boundary value) is moved to the 30% position of the display scale (boundary value displacement position). The section below the boundary (accounts for 30% of the entire display) represents -6 V to 0 V and the section above the boundary (accounts for 70% of the entire display) represents 0 V to 6 V.

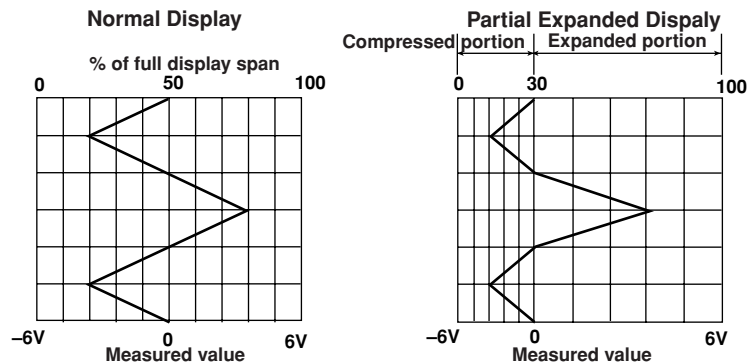

Digital Screen

The measured/computed data are displayed using numerical values in large size. See section “4.3.”

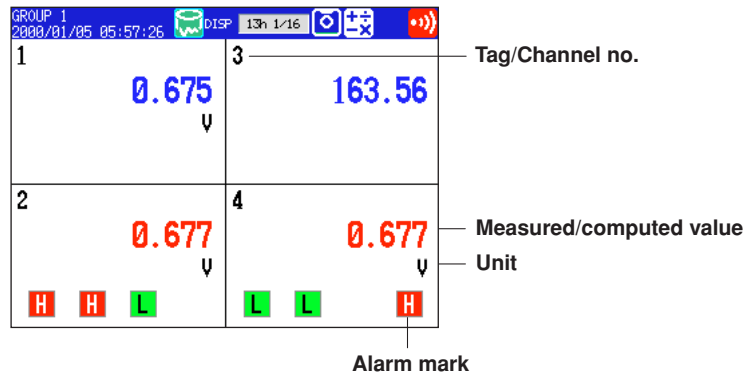

Updating of the Numerical Display

Measured/computed values are updated every second. However, when the scan interval on the DX106L/DX112L is 2 s, the display update rate is also 2 s.

Bar graph Screen

The measured/computed data are displayed using bar graphs. See section 4.3.

Bar Graph Display (Vertical)

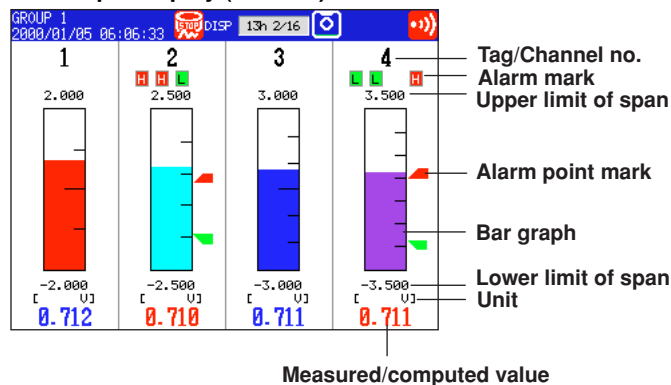

Updating of the Bar Graph and the Numerical Display

Measured/computed values are updated every second. However, when the scan interval on the DX106L/DX112L is 2 s, the display update rate is also 2 s.

Displayed Information

The following Information can be displayed.

Information	Description
Display direction	The bar graphs can be displayed horizontally or vertically. ⇒ “Section 7.13”
Base position	When the bar graph is displayed horizontally, the starting point of the bar (base position) can be set to the minimum edge of the measurement scale or to the center position. ⇒ “Section 7.10”
Displayed color	The displayed color of the channels are common with the trend display. ⇒ “Section 7.8”
Scale display	The number of divisions of the scale can be set to a value in the range 4 to 12. ⇒ “Section 7.10” (common with the trend display)

1.3 Display Function

Overview Screen

A list of measured/computed values and alarm conditions of all measurement/computation channels is displayed. You can move the cursor to select a channel and display the trend or bar graph of the group containing the selected channel. For the procedure used to display the overview, see section 4.4.

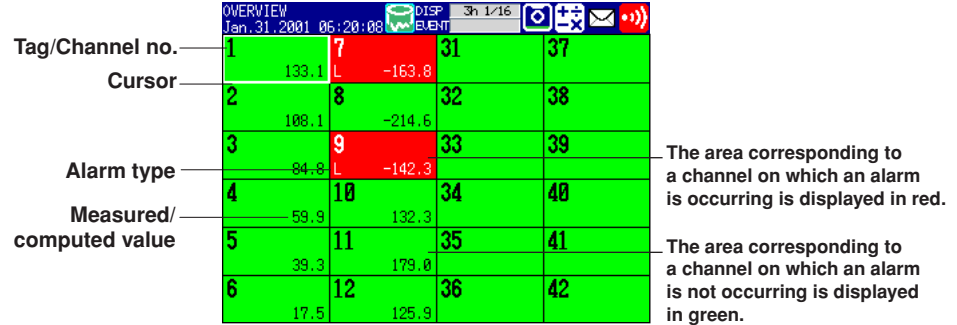

Updating of the Numerical Display

Measured/computed values are updated every second. However, when the scan interval on the DX106L/DX112L is 2 s, the display update rate is also 2 s.

Alarm Summary

A list of the most recent alarms can be displayed. By scrolling the screen using arrow keys, up to 120 incidents can be displayed.

By selecting an alarm from the list using arrow keys, the historical trend of the display data or event data containing the alarm can be recalled. For a description on the historical trend display, see "Historical Trend" in this section. For the operating procedure, see section 4.5.

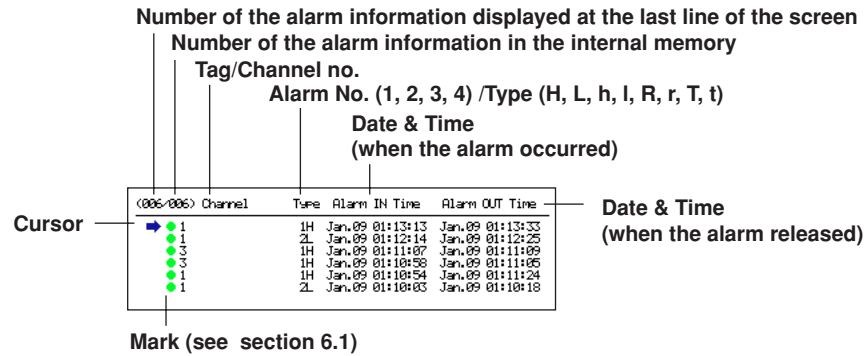

Message Summary

The messages that were entered in the trend display and the times when they were entered (message information) are displayed in a list. By scrolling the screen using arrow keys, up to 100 incidents can be displayed.

By selecting a message from the list using arrow keys, the historical trend of the display data or event data containing the message can be recalled. For a description on the historical trend display, see "Historical Trend" in this section. For the operating procedure, see section 4.5.

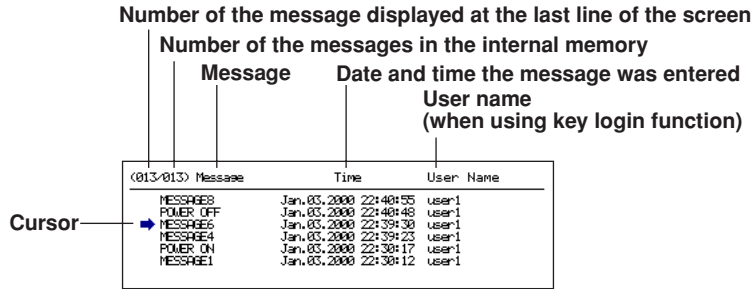

Memory Summary

The information pertaining to the display data file and event data file in the internal memory is displayed. Display data correspond to the data on the trend display. Event data are data acquired to the internal memory according to the specified sampling interval and data collection period. The data are separate from the display data.

In addition, the number of manual sampled data, TLOG data (option), and report data (option) residing in the internal memory are displayed. For models that have the alarm output relays (option), the ON/OFF state of the relays are also listed.

For details related to the data residing in the internal memory, see section 1.4.

By selecting the display data file or event data file using the arrow keys, the historical trend display can be recalled. For a description on the historical trend display, see "Historical Trend" in this section. For the operating procedure, see section 4.5.

Number of data sets in the internal memory/The maximum number of data sets the internal memory can hold

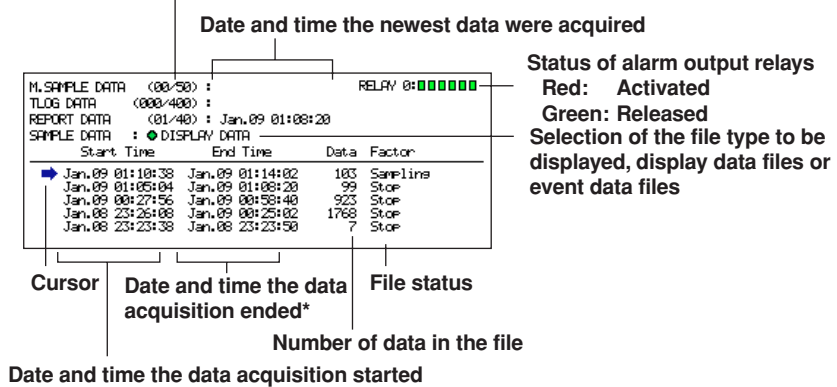

* For models with the batch function (/BT1 option), a batch number and lot number can be displayed in place of the date and time when the data acquisition ended. For the setting procedure, see section 10.12.

1.3 Display Function

Report Data (/M1 option)

Report data residing in the internal memory can be displayed. The report function is used to write the average, minimum, maximum, and sum at specified intervals for the specified channels. Reports can be made hourly, daily, weekly, or monthly. For details related to the report data, see section 1.6. For the operating procedure, see section 4.5.

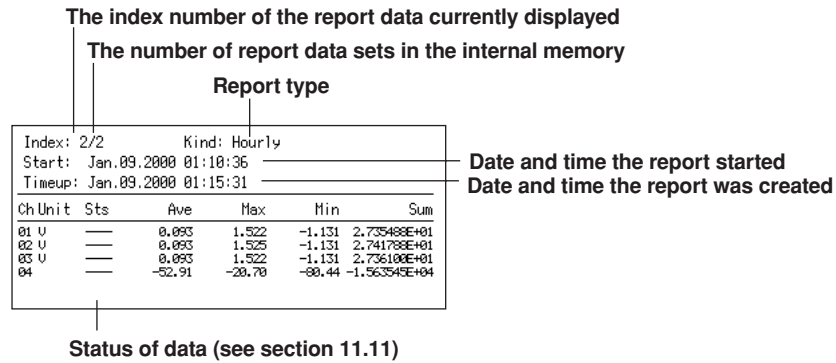

Historical Trend

The display data and event data of the measured/computed data stored in the internal memory or external storage medium are displayed as a historical trend. For details related to the display data, see “Trend Display” in this section. For details related to the event data, see section 1.4.

Alarms and scales are not displayed on the historical trend display.

Methods Used to Display the Historical Trend

- The following four methods are available in displaying the historical trend of the display data or event data in the internal memory:
 - Display from the alarm summary. For the operating procedure, see section 4.5.
 - Display from the message summary. For the operating procedure, see section 4.5.
 - Display from the memory summary. For the operating procedure, see section 4.5.
 - Recall from the screen menu. For the operating procedure, see section 4.6.
- For methods used to display the historical trend of display data or event data in the external storage medium, see section 9.3 and 9.4.

Information Displayed on the Historical Trend

The displayed information shown below is common to the historical trend of display data and event data.

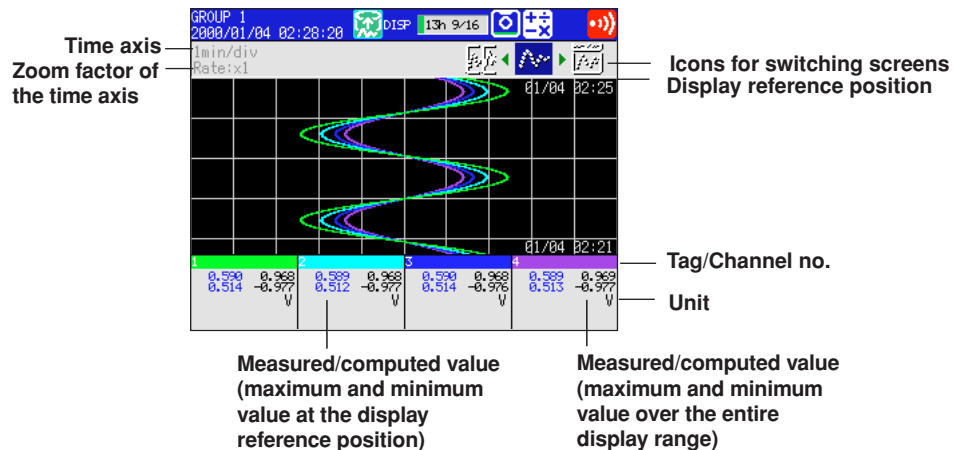

- The waveform can be scrolled along the time axis using the cursor keys.
- The time axis can be expanded or reduced.
- The entire data of the file that is being displayed on the historical trend can be displayed at the top section of the screen (right section if the trend display is vertical). You can specify the position to be displayed on the historical trend display using a cursor. The specified position becomes the display reference position.

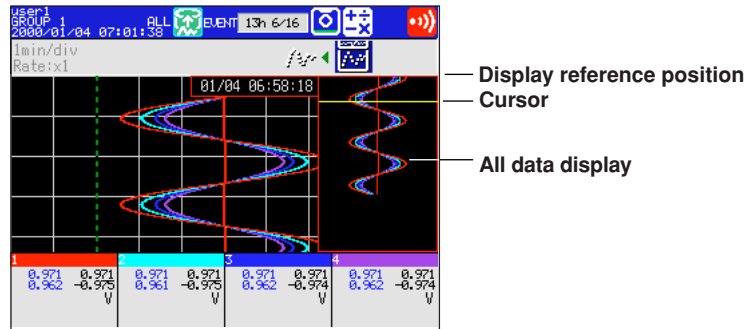

- The memory information of the file being displayed on the historical trend can be displayed. For models with the batch function (/BT1 option), information such as the batch number and lot number are also displayed.

File Name (Data Kind):	Memory (DISP)	File name and data type
Serial No.	: 12V921463	Serial number of the instrument that sampled the data
Start Time	: Jan.03.2000 07:55:04	Start/stop time and user name (user name is displayed only when the key login function is used)
Start User Name	: user1	
End Time	: Jan.03.2000 07:55:18	
End User Name	: user1	

Half Screen Display (Only when displaying the historical trend of the display data)

Displays the historical trend of the display data on the lower half of the screen (left half if the trend display is horizontal) and the current display data on the upper half of the screen (right half if the trend display is horizontal). For the operating procedure, see section 4.6.

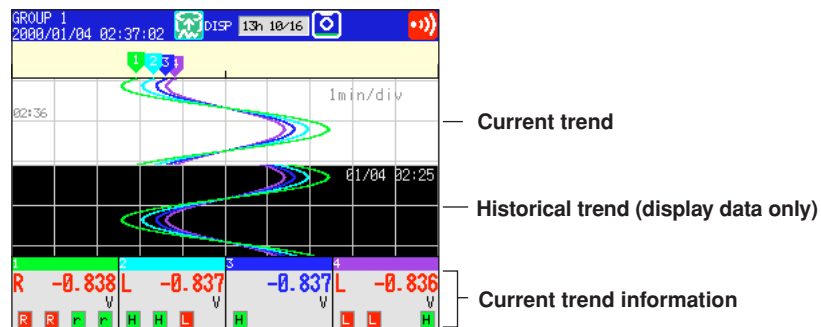

Setting Screen

The various functions of the DX100L are configured using the setting mode or the basic setting mode.

Setting Mode Screen

This screen is used to set the input range, filter/moving average, alarm, group, channel display color, etc. For details, see section 3.5.

- **Setting screen example for the setting mode**

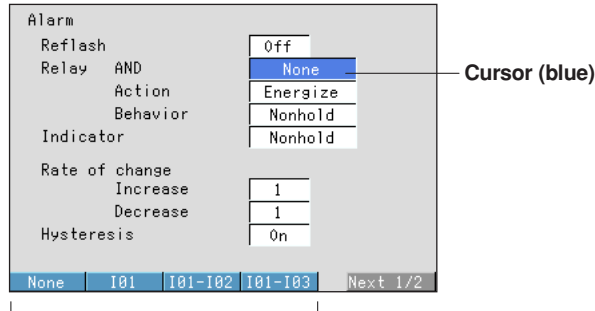

Parameter selections (selected using the soft keys)

Basic Setting Mode Screen

This screen is used to configure the basic specifications of the various functions such as burnout, reference junction compensation, A/D integration time, and the method used to acquire data to the internal memory. For details, see section 3.5.

- **Setting screen example for the basic setting mode**

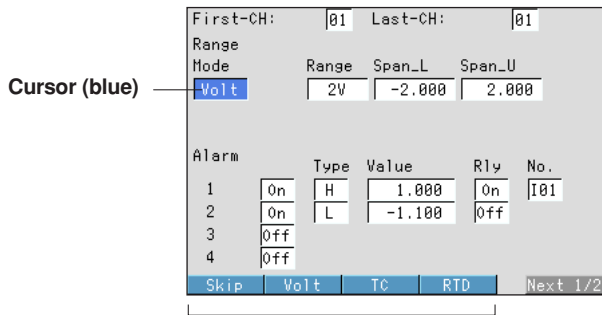

Parameter selections (selected using the soft keys)

Setting the Display Conditions of the LCD

The following display conditions of the LCD can be configured.

Screen Attribute	Settings
Background color of the operation screen	You can select white or black for the background color of the screen. The initial setting is "white." For the setting procedure, see section 7.13.
LCD brightness	The brightness of the LCD can be set between eight levels. The initial setting is "4." For the setting procedure, see section 7.14.
Backlight saver	The lifetime of the LCD backlight can be extended by automatically dimming the light when there is no key operation for a certain amount of time. The screen returns to the original brightness with a key operation or an alarm occurrence. The initial setting is set so that the backlight saver is disabled. For the setting procedure, see section 7.14.

1.4 Storage Function

Acquiring Data to the Internal Memory

Display Data and Event Data

The measured/computed data are first acquired to the DX100L's internal memory as two types of data, display data and event data. Then, the data are saved to the external storage medium automatically or when the external storage medium is inserted into the drive. You can select whether to save the measured/computed data as display data, event data, or as both.

The capacity of the internal memory for acquiring display data and event data is 1.2 MB. When the measured/computed data are saved as both display data and event data, 0.9 MB is used to save display data and 0.3 MB is used to save event data.

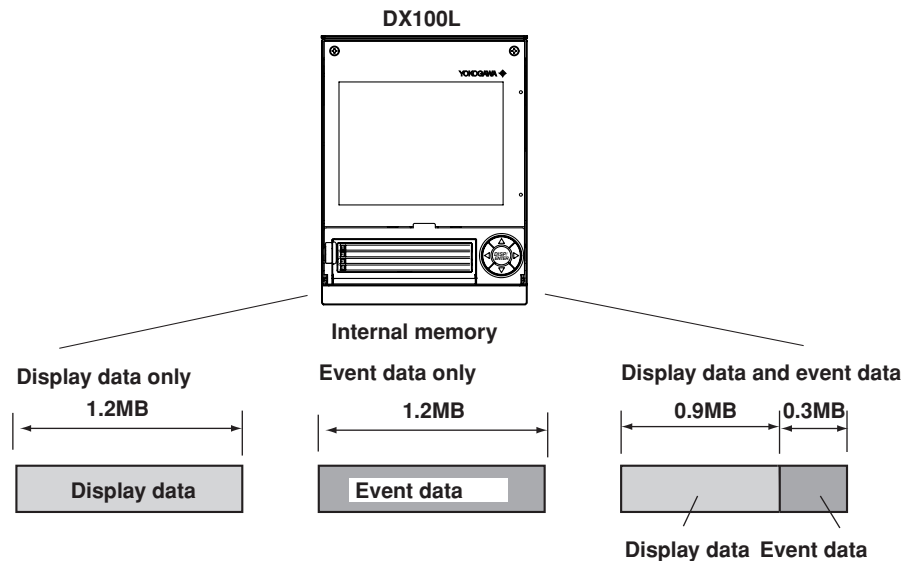

Display data are used to display waveforms on the DX100L's screen. Display data consists of maximum and minimum values of the measured or computed data sampled at the scan interval within the time period corresponding to one dot on the time axis on the screen. Display data can be likened to the conventional recording on the chart sheet and are useful for long-term observations.

Event data are instantaneous values of the measured/computed data at specified sampling intervals of the event data. By setting the sampling interval equal to the scan interval, all measured or computed data sampled at the scan interval can be saved. In addition, the event data generated when an event occurs (an alarm, for example) can also be saved. This is useful when you wish to observe the measured/computed data in detail.

For detail, see sections 8.1 and 8.2.

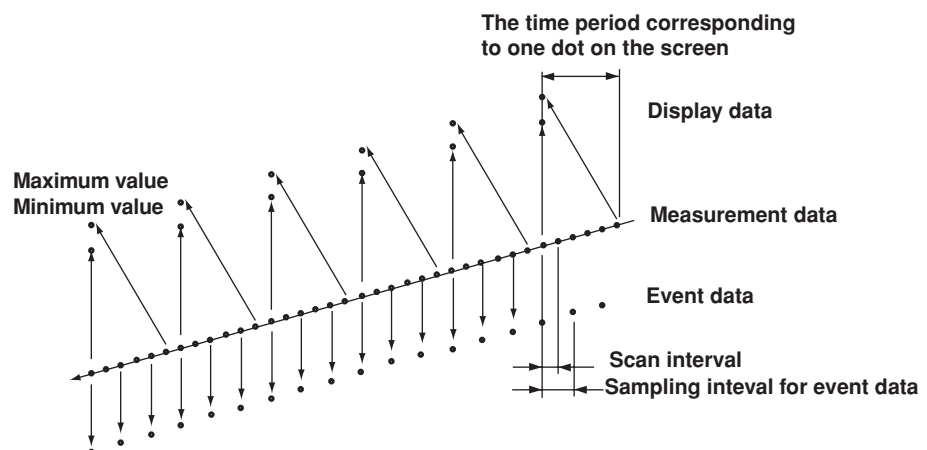

Manual Sampled Data

Every time a given key operation is carried out, all measured/computed data (instantaneous values) at that point are acquired to the internal memory. However, this excludes measurement channels that are skipped and computation channels that are turned OFF. For the action of acquiring data and the operating procedure, see sections 8.1, 8.3, and 8.12.

TLOG Data (Only on models with the optional computation function (/M1))

All measured/computed data (instantaneous values) can be acquired to the internal memory at predetermined intervals. However, this excludes measurement channels that are skipped and computation channels that are turned OFF. For the action of acquiring data, see sections 8.1 and 8.3.

Report Data (Only on models with the optional computation function (/M1))

The average, maximum, minimum, and sum can be computed for the specified channels at predetermined intervals and the result can be acquired to the internal memory. You can select one hour (hourly report), one day (daily report), one hour/one day (hourly and daily reports) one day/one week (daily and weekly reports), or one day/one month (daily and monthly reports) for the interval. For the action of acquiring data, see sections 8.1 and 8.3.

Saving Data to the External Storage Media

External Storage Media

Various data can be saved to the following storage media:

- 3.5" floppy disk (1.44 MB, 2HD)
- Zip disk*
- ATA flash memory card: The size varies depending on the memory card that you are using.

* This product is no longer produced.

Save Method

There are two methods of saving data to the external storage medium. One method is to insert the storage medium to the drive when data is to be saved (referred to as manual save). The other method saves data automatically at certain time intervals to a storage medium that has been inserted into the drive beforehand (referred to as auto save).

Other Types of Data That Can Be Stored

In addition to the types of data described in "Acquiring Data to the Internal Memory," the following types of data can be stored on the external storage medium.

- **Setting data**

The DX100L setting data, such as the setting of the functions of the input section as described in section 1.2, can also be stored to an external storage medium to the specified file name. The stored data can also be loaded and used by the DX100L.

- **Image data of the display screen**

The image data of the display screen can be stored to the external storage medium. The image data can be pasted to documents created on a PC.

Saving Data via Ethernet

The display data, event data, and report data, as described in "Acquiring Data to the Internal Memory," can be automatically transferred to an FTP server via Ethernet for storage. Conversely, the DX100L can operate as an FTP server. The DX100L can be accessed from a PC and the data in the external storage medium can be retrieved for storage. For these functions, see the DX100/DX200 Communication Interface User's Manual (IM 04L02A01-17E).

1.5 Alarm Function

This function generates an alarm when the measured/computed data meets a certain condition. When an alarm occurs, information notifying the alarm occurrence is displayed on the screen. In addition, a signal can be output from the relay output terminals on the rear panel of the DX100L (only on models with the optional alarm output relay function (/AR1, /AR2, or /A3)).

Alarm Indication

The alarm conditions are displayed as alarm icons in the status display section and through the trend, digital, bar graph, overview and other screens. The detailed information about the alarms is displayed in the alarm summary.

There are two methods in displaying alarms. One method is to clear the alarm display when the cause of the alarm is no longer met (non-hold display). The other method is to display the alarm until the alarm is confirmed (hold display).

Alarm Indication Example (Overview display and alarm summary display)

Tag/Channel no.	1	7	31	37
Cursor	133.1	-163.8		
	2	8	32	38
	108.1	-214.6		
Alarm type	3	9	33	39
	84.8	-142.3		
Measured/computed value	4	10	34	40
	59.9	132.3		
	5	11	35	41
	39.3	179.0		
	6	12	36	42
	17.5	125.9		

Number of the alarm information displayed at the last line of the screen
 Number of the alarm information in the internal memory
 Tag/Channel no.
 Alarm No. (1, 2, 3, 4) /Type (H, L, h, l, R, r, T, t)
 Date & Time (when the alarm occurred)

Cursor	(006/006) Channel	Type	Alarm IN Time	Alarm OUT Time
1	1	H	Jan.09 01:13:13	Jan.09 01:13:33
2	1	L	Jan.09 01:12:14	Jan.09 01:12:25
3	3	H	Jan.09 01:11:07	Jan.09 01:11:09
3	3	H	Jan.09 01:10:59	Jan.09 01:11:05
1	1	H	Jan.09 01:10:54	Jan.09 01:11:24
1	1	L	Jan.09 01:10:03	Jan.09 01:10:18

Mark (see section 6.1)

Number of Alarms

You can set up to four alarms for each channel.

Alarm Conditions

The following eight conditions are available:

- **Upper limit alarm (H)**
An alarm occurs when the measured value exceeds the alarm value.
- **Lower limit alarm (L)**
An alarm occurs when the measured value falls below the alarm value.

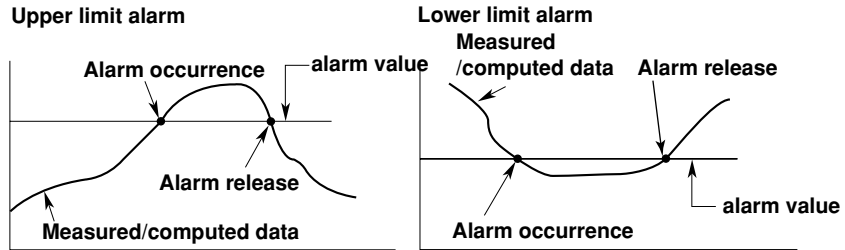

- **Delay upper limit alarm (T)**
An alarm occurs when the measured value remains above the alarm value for the specified time period (delay period).
- **Delay lower limit alarm (t)**
An alarm occurs when the measured value remains below the alarm value for the specified time period (delay period).

Delay upper limit alarm example (T is the specified delay period)

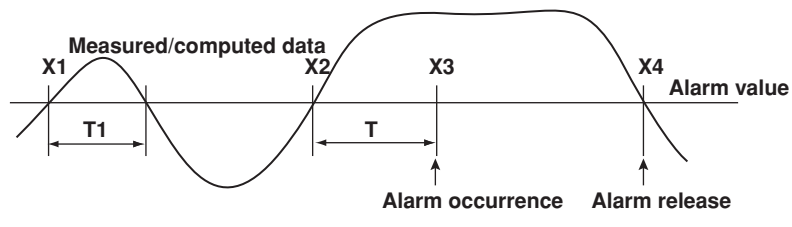

- Alarm does not occur at T1, because the time period is shorter than the specified delay period (T).
- The input exceeds the alarm value at X2, but the alarm occurs at X3 at which the specified delay period elapses (the time when the alarm occurs is the time at X3).
- The input falls below the alarm value at X4 and the alarm is released.
- **Difference upper limit alarm (h)^{*1}**
An alarm occurs when the difference between the measured values of two channels becomes greater than or equal to the alarm value.
- **Difference lower limit alarm (l)^{*1}**
An alarm occurs when the difference between the measured values of two channels becomes smaller than or equal to the alarm value.
*1 Can be specified only on difference computation channels.
- **Upper limit on rate-of-change alarm (R)^{*2}**
The amount of change of the measured values over a certain time interval is checked. An alarm occurs when the amount of increase becomes greater than or equal to the specified value.
- **Lower limit on rate-of-change alarm (r)^{*2}**
The amount of change of the measured values over a certain time interval is checked. An alarm occurs when the amount of decrease becomes greater than or equal to the specified value.
*2 Can be specified only on measurement channels.

Upper limit on rate-of-change alarm

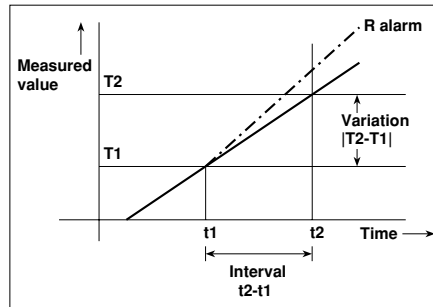

Lower limit on rate-of-change alarm

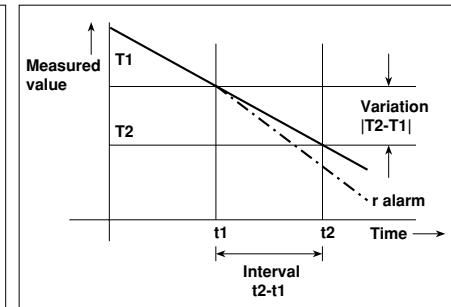

The interval is defined by the following equation and is set in terms of the number of measured data points.

$$\text{Interval} = \text{scan interval} \times \text{number of measurements}$$

Alarm Hysteresis

This applies to upper (H) and lower (L) limit alarms on measurement channels. A width (hysteresis) can be specified on the value used to set or release the alarm. This prevents the alarm from being set or released repetitively when the measured value is fluctuating around the alarm value. The hysteresis is fixed to 0.5% of the display span (display scale if the range is set to [Scale]). The initial setting is [ON].

Upper Limit Alarm (H)

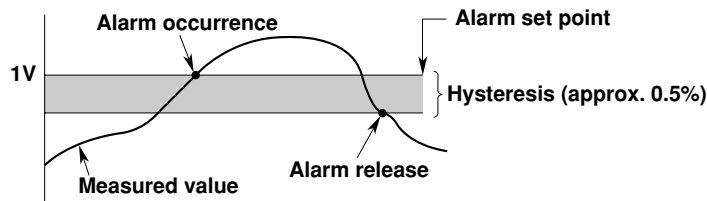

Lower Limit Alarm (L)

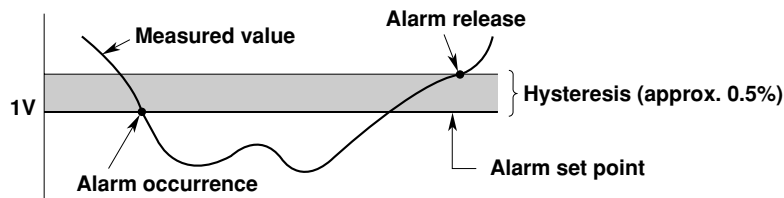

Alarm Output Relay

If you are using a model with the optional alarm output relay (/AR1, /AR2, or /A3), a contact signal can be generated according to the alarm conditions. For the procedure related to setting the alarm output relay, see section 6.2, "Alarm Setting."

The following functions can be specified on the alarm output relay. For details, see section 6.4.

- When multiple alarms are set to one alarm output relay, notify the succeeding alarms after the first alarm that causes the relay operation (reflash alarm function).
- When multiple alarms are set to one alarm output relay, operate the relay when all specified alarms are active (AND function)
- Energize or de-energize the alarm output relay when the alarm occurs (energize/de-energize function of the output relay).
- When the alarm changes from the ON state to the OFF state (return to normal condition), turn OFF the output relay with an alarm ACK operation (output relay hold function).

1.6 Computation Function and Report Function (/M1 Option)

Computing equations are assigned to channels that are dedicated to performing computations. Displaying computation channels and acquiring computed data can be carried out in the same manner as in the measurement channels. The computation is performed every scan interval. For detail, see sections 11.1 and 11.2.

Computation channels

Model	Channel
DX102L	Channels 31 to 34 (4 channels)
DX104L	Channels 31 to 34 (4 channels)
DX106L	Channels 31 to 42 (12 channels)
DX112L	Channels 31 to 42 (12 channels)

Types of Computations

The following types of computations can be performed.

Type	Description
Four arithmetical operations	Addition (+), subtraction (-), multiplication (x), and division (/)
SQR	Computes the square root.
ABS	Determines the absolute value.
LOG	Determines the common logarithm.
EXP	Determines the exponent.
Relational computation	Determines <, ≤, >, ≥, =, ≠ of two elements and outputs "0" or "1."
Logical computation	Determines the AND (logical product), OR (logical sum), XOR (exclusive logical sum) of two elements, NOT (negation) of an element and outputs "0" or "1."
Statistical computation (TLOG)	Determines the average (AVE), maximum (MAX), minimum (MIN), sum (SUM), and maximum - minimum (P-P) at specified time intervals for the specified channels. You can specify the interval. For detail, see section 11.7.
Rolling average	Determines the moving average of the computed result at scan intervals for the channel for which the equation is specified. The sampling interval and the number of samples are specified for each channel. The maximum sampling interval is 1 hour, the maximum number of samples is 64. The initial setting is set so that the rolling average is disabled.

The following elements can be used in the computing equations.

Element	Description
Measured data	Values measured on the measurement channels.
Computed data	Values computed on the computation channels.
Constants (K01 to K12)	Set by the computation function.
Communication input data (C01 to C12)	Set by the communication function. ⇒ "DX100/DX200 Communication Interface User's Manual"
Condition of the remote control terminals (D01 to D08)	Use ON/OFF (1 or 0) of the remote input signal.

Report Function

The report function is one of the functions provided by the optional computation function (/M1).

This function computes the average, maximum, minimum, and sum for the specified channels at specified intervals and writes the result to the internal memory.

You can select the report type from hourly reports only, daily reports only, hourly and daily reports, daily and monthly reports, and weekly and monthly reports. The reports are created every hour on the hour for hourly reports, at the specified hour on the hour for daily reports (once a day), at the specified hour on the hour on the specified day for weekly reports (once a week), and at the specified hour on the hour on the specified date for monthly reports (once a week).

For example, in the case of daily reports, the average, maximum, minimum, and sum over a day for the specified channels are computed at the specified time (on the hour), and the results are acquired to the internal memory. This constitutes one report data set. The report data residing in the memory can be displayed on the DX100L's LCD (see section 1.3, "Display Function").

In addition, the report data residing in the internal memory can be saved to an external storage medium (section 1.4, "Storage Function"). Because the report data are saved to the external storage medium in ASCII format, spreadsheet applications can be used to view the data (see appendix 2, "Data Format of ASCII Files").

For details related to the report function, see section 11.11.

Item	Description
Report type	Select from hourly reports only, daily reports only, hourly and daily reports, daily and weekly reports, and daily and monthly reports.
Number of channels per report	Up to 12 channels
Computed data	Average, maximum, minimum, and sum
Number of reports that can be acquired to the internal memory	Up to 40
Data format	ASCII format

For a display example of report data, see section 1.3.

1.7 Batch Function (/BT1 Option)

Batch function is used to include information such as batch numbers and lot numbers along with the data acquired to the internal memory. By including information such as batch numbers, lot numbers, and supervisor names along with the measured/computed data, you will be able to manage the stored data. By using the key login function in combination with this function, the operators that are allowed to store data on the DX100L can be restricted and identified.

Adding Batch Information to the Measured/Computed Data (Display Data and Event Data)

The following information can be added to the display data and event data acquired to the internal memory. For the setting procedure, see section 10.12.

The operator can change the batch number, lot number, and comment for each lot. In addition, the lot number can be automatically increased by one when one lot is complete.

- Serial number of the DX100L (the number written on the name plate of the DX100L).
- Application name (up to 16 characters).
- Supervisor name (up to 16 characters).
- Manager name (up to 16 characters).
- Batch name
 - Batch number (up to 16 characters).
 - Lot number (0 to 9999).
- Start information.

Start date and time and user name* (up to 16 characters).

* Only when the key login function is used.
- Stop information.

Stop date and time and user name* (up to 16 characters).

* Only when the key login function is used.
- Comment information.
 - Comment (up to 32 characters x 3 lines).
 - The date and time when comment was written.
 - User name* of the user who wrote comment (up to 16 characters).

* Only when the key login function is used.

Identifying Operators (Users) by using the Key Login Function

By using the key login function, the users that can log into the DX100L can be restricted and identified. When the batch function is activated, the security is enhanced in the following manner as compared with the standard key login function. For the operating procedure of the key login function, see section 10.5. For the setting procedure, see section 10.6.

- User names that are already registered cannot be specified.
- The combinations of user IDs and passwords that are identical to those that have been registered by any user in the past cannot be specified.

Changing the Messages

When the optional batch function is installed, messages 1 through 3 can be changed in the operation mode. For the procedure related to changing the messages, see section 7.4.

Display

The following items are displayed:

- The batch number/lot number and date/time are alternately displayed in the status display section. See section 4.1.
- When the STOP key is pressed, batch information is displayed in the stop confirmation screen. See sections 8.5 and 8.6.

Confirming the Stored Data

The display data and the event data in the internal memory or the external storage medium, can be displayed on the historical trend display.

- When the historical trend of the display data or event data in the internal memory or in the external storage medium is displayed, batch information can be shown in the memory information display. See section 4.6.
- The batch number and lot number for each file can be displayed in place of the date and time of the file creation on the memory summary screen and on the screen used to select the display data and event data to be loaded from the external storage medium. See sections 4.5, 9.3, and 9.4.

1.8 Other Functions

USER key

One of the following actions can be assigned to the USER key. "Alarm ACK" is initially assigned. For the setting and operating procedure, see section 10.2, and 10.1, respectively.

Action That Can Be Assigned

Name of Action	Action
None	None
Trigger	Provides a key trigger for starting acquiring the event data. (when [Key Trigger] is set as a trigger to start acquiring event data) ⇒ "Section 8.11"
AlarmACK	Release alarm indication and relay output (when alarm display and alarm output relay action is set to "hold." ⇒ "Section 6.4")
Math	Starts/stops computation. (when the computation function (/M1) is equipped) ⇒ "Section 11.3"
Mathrst	Clears computed results. (when the computation function (/M1) is equipped and the computation is suspended) ⇒ "Section 11.3"
M.sample	Stores instantaneous values of all channels to the internal memory. ⇒ "Section 8.13"
Message 1 to Message 8	Displays messages and stores them to the internal memory. ⇒ "Section 7.4"
Snapshot	Saves the screen image data to the external medium. ⇒ "Section 9.6"

Key Lock

Key lock is a function that locks key operations, removal of the Zip disk, and the saving of data to the external storage medium during manual save mode.

A password needs to be entered to release the key lock. For the setting and operating procedure, see section 10.4, and 10.3, respectively.

Items and Behaviors of the Key Lock (Can be set individually)

Item	Behavior during Key Lock
START key	Disabled
STOP key	Disabled
MENU key	Disabled
USER key	Disabled
DISP/ENTER key	Switching operation screens is disabled.
[Alarm ACK] soft key	Disabled
Math (Computation)	
• [Math START] soft key ^{*1}	Disabled (option)
• [Math STOP] soft key ^{*1}	Disabled (option)
• [Math reset] soft key ^{*1}	Disabled (option)
Write memory	
• [Message] soft key ^{*2}	Disabled
• [Manual sample] soft key ^{*2}	Disabled
• [Trigger] soft key ^{*2}	Disabled
• [Save Display] soft key ^{*2}	Disabled
• [Save Event] soft key ^{*2}	Disabled
• [E-Mail START] soft key ^{*2}	Disabled
• [E-Mail STOP] soft key ^{*2}	Disabled
• [E-Mail test] soft key ^{*2}	Disabled
Media (External storage medium)	
• During manual save	Prevent saving when an external storage medium is inserted. Prevent Zip disk removal.
• During auto save	Prevent Zip disk removal.

*1 Set together by [Math] parameter.

*2 Set together by [Write memory] parameter.

Key Login/Logout

This function allows only certain users to access the DX100L. The users are distinguished by their name, user IDs, and passwords. You can select whether or not to use User IDs. In addition, you can set whether or not to allow operations in the basic setting mode for each user. Up to 7 users can be registered.

For the key login function with Batch function (/BT1 option), see section 1.7.

For the setting and operating procedure, see section 10.6, and 10.5, respectively.

Log Display

A list of phenomena that occurred can be displayed in the order of occurrence for the following items:

- Error messages (50 most recent messages)
- A log of key login and logout (50 most recent logins)
- A log of communication commands (200 most recent commands)
- A log of file transfers using the FTP client function (50 most recent transfers)
- A log of e-mail transmissions (the 50 most recent transmissions)
- A log of Web operations (the 50 most recent operations)

For details related to the display format, see section 10.7.

Error Log Example

Displays the date and time of the error occurrence, error code number, and the message.

The number of the log displayed at the last line of the screen / total number of logs

(002/002)	Time	No.	Message
Jan.31.2001	07:23:33	210	Media has not been inser..
Jan.31.2001	07:23:23	601	Measured data have been ..

System Screen

The total number of inputs on the DX100L, the capacity of the internal memory, the communication functions, the external storage drive, the options, the MAC address, and the firmware version number can be displayed. For the operating procedure, see section 10.7.

Number of measurement channels*		Number of computation channels		
ANALOG: 12	MATH: 12			
MEMORY: 1200000				Internal memory capacity
OPTION:				Optional functions
REHOTE				Communication function
RS-232				External storage medium drive
ETHERNET				Optional functions
FDD				
ALARM 6				
BATCH				
PRODUCT:				MAC address
MAC address 00:00:64:00:B8:A9				Firmware version number
Version 4.01	Graphic : 4.01			

* When the cramped input terminal is equipped (/H2 option), "C" is indicated as "ANALOG: 12(C)" in this example.

Displayed Language

The displayed language can be set to English, Japanese, German, or French. For the setting procedure, see section 10.10.

FAIL/Memory End Output (/F1 option)

Operation at System Failure

This function activates the relay output when the CPU fails. The relay is de-energized on CPU failure. The relay is de-energized if the CPU fails. This relay action cannot be reversed to “energized on failure” and thus this relay is de-energized also upon power-off (including a power failure).

Relay Behavior (De-energized on failure)

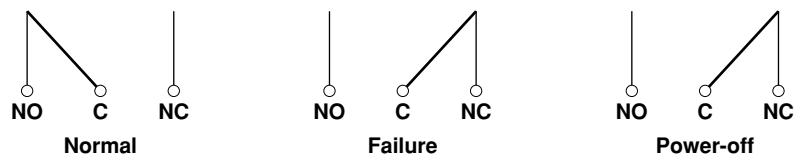

NO, C, and NC denote normally-opened, common, and normally closed, respectively.

Operation at Memory End

This function activates the relay output when the remaining space (time) in the internal memory or the external storage medium becomes small. The relay is energized if the memory end is detected. The relay action cannot be reversed to “de-energized on memory end.” When the relay is energized, save the data in the internal memory to the external storage medium during manual save, or use another external storage medium during auto save.

The memory end detection operates as follows.

- **When using auto save**

When using auto save and the storage medium is inserted, the relay is energized when the remaining space on the storage medium falls to 10%. At this point, the icon of the external storage medium on the status display section on the screen turns to red from green. See section 4.2.
- **When using manual save**
 - When the type of data to be acquired is display data only or display data and event data

When the remaining time for storing the display data in the internal memory falls to the specified time, the relay is energized.
 - When the type of data to be acquired is event data only

In the [Free] mode, the relay is energized when the remaining time for storing the event data in the internal memory falls to the specified time.

In the [Trigger] or [Rotate] mode, the relay is not energized (There is no memory end output).

- **Relay behavior (energized on memory end)**

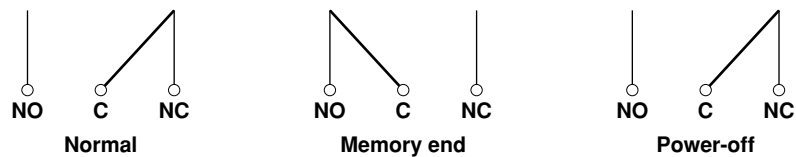

NO, C, and NC denote normally-opened, common, and normally closed, respectively.

For the setting procedure, see section 10.8.

Remote Control Function (/R1 option)

When a contact or open collector signal is applied to the remote control terminal, a predetermined action is carried out.

Arbitrary actions can be assigned to the eight remote control terminals. The available actions are listed below.

For the setting procedure, see section 10.9.

Name of Action	Remote Signal	Action
None	-	No operation.
Start/Stop	Edge	Start/stop acquiring data to the internal memory. ⇒ "Sections 8.4 and 8.5"
Trigger	Trigger	Trigger to start acquiring event data to the internal memory (valid only when event data are specified to be acquired to the internal memory and the trigger used to start the acquisition is set to external trigger ⇒ "Section 8.11")
Alarm ACK	Trigger	Release alarm display/relay output (valid only when the operation of the alarm display or output relay is set to "hold" ⇒ "Section 6.4").
Time adj	Trigger	Adjust the internal clock to the nearest hour.
Computation (Math)	Edge	Start/stop computation (only for models with the computation option (/M1).
Computation (Math) reset	Trigger	Reset the computed value of the computation channel (reset to 0, only on models with the computation option (/M1) while the computation is stopped).
Manual sample	Trigger	Write the instantaneous values of all channels to the internal memory once.
Load setup data 1 to 3	Trigger	Load and activate the setup data file that had been created and stored in the external storage medium.
Messages 1 to 8	Trigger	Display messages 1 to 8 on the trend display and write them to the internal memory.
Snapshot	Trigger	Save the screen image data to the storage medium.

Remote Signal (Edge and trigger)

The above actions are carried out on the rising or falling edge of the remote signal (edge) or the ON signal lasting at least 250 ms (trigger).

Rising/Falling edge

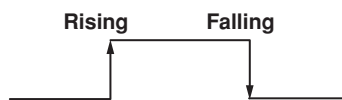

Trigger

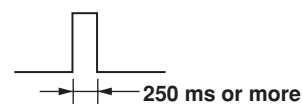

For contact inputs, the remote signal rises when the contact switches from open to close and falls when the contact switches from close to open. For open collector signals, the remote signal rises when the collector signal (voltage level of the remote terminal) goes from high to low and falls when the collector signal goes low to high.

Daylight Savings Time

- When the specified time is reached at which the daylight savings time adjustment is to be enabled, the DX100L automatically sets the clock ahead by one hour.
(Example: If the time is set to 9 o'clock on June 1, the time is set ahead to 10 o'clock June 1.)
- When the specified time is reached at which the daylight savings time adjustment is to be disabled, the DX100L automatically sets the clock back by one hour.
(Example: If the time is set to 9 o'clock on December 1, the time is set back to 8 o'clock December 1.)

For the setting procedure, see section 10.14.

Temperature Unit

The temperature unit can be set to Celsius (°C) or Fahrenheit (°F). This applies to all channels.

For the setting procedure, see section 10.15.

24 VDC Power Supply for Transmitter (/TPS2, /TPS4 option)

Provides 24 VDC power to transmitters.

2.1 Precautions on the Use of the DX100L

Read the following precautions before using the DX100L and the external storage medium (floppy disk, Zip disk, ATA flash memory card).

Handling Precautions

- Use care when cleaning the DX100L, especially any plastic parts. When cleaning, wipe with a dry, soft cloth. Do not use chemicals such as benzene or thinner, since these may cause discoloring and deformation.
- Keep electrically charged objects away from the DX100L as this may cause malfunction.
- Do not apply volatile chemicals to the LCD monitor or panel keys. Do not allow rubber and vinyl products to remain in contact with the DX100L for long periods of time. This may damage the DX100L.
- Do not apply shock to the DX100L.
- When not in use, make sure to turn OFF the power switch.
- If there are any symptoms of trouble such as strange odors or smoke coming from the DX100L, immediately turn OFF the power and unplug the power cord. Then, contact your nearest YOKOGAWA dealer.

Handling precautions of external storage media

- Take special care in handling external storage media as they are delicate products. For general precautions, see the instruction manual that came with the external storage medium.
- Floppy disks and Zip disks may not operate properly under high or low temperature environment. If you are using the DX100L in a low-temperature environment (less than 10°C), let the DX100L warm-up for at least 30 minutes beforehand.
- If you are using them in a high-temperature environment (greater than 40°C), we recommend the external storage medium be inserted into the drive when saving the data and be removed after the data have been saved (“manual save,” see section 8.4.)
- Remove the external storage medium from the drive when turning ON/OFF the DX100L.
- Do not remove the external storage medium while the access lamp is lit. Doing so can destroy the data on the medium.
- If you are using a commercially available compact flash card on DX100Ls in the ATA flash memory card drive, be careful of static electricity. The DX100L may not operate properly if you touch the compact flash card that is inserted into the DX100L when your body is charged with static electricity.
- Handling the CF Card and Adaptor
Insert the CF card into the adaptor as shown in the figure below. The card should remain in the adaptor when removing it from the card slot on the DX100L.

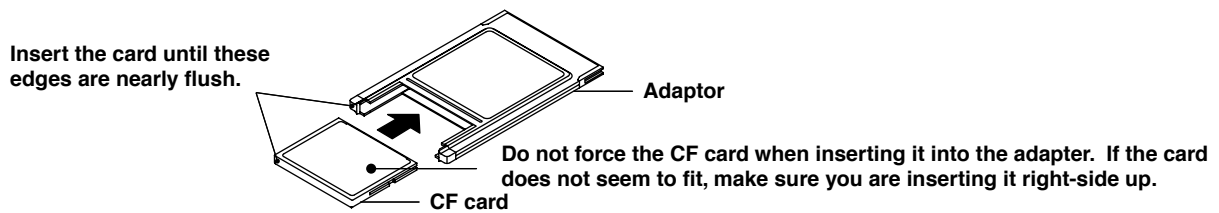

CAUTION

Don't expose the floppy disk drive or Zip drive to vibration or shocks, as it may damage the drives.

2.2 Installing the DX100L

Installation location

Install the DX100L indoors, in a location that meets the following conditions. See also the normal operating conditions described in section 14.7, “General Specifications.”

- **Instrument panel**
The DX100L is designed for panel mounting.
- **Well-ventilated location**
To prevent overheating, install the DX100L in a well-ventilated location. For the panel mount type, see “Panel Cutout” in section 14.8, “Dimensional Drawings.”
- **Minimum mechanical vibrations**
Choose an installation location with the minimum mechanical vibration.
- **Horizontal**
Install the DX100L horizontally (However, the DX100L can be inclined up to 30 degrees backwards for panel mounting).

Note

- Condensation may occur if the DX100L is moved to another place where both the ambient temperature and humidity are higher, or if the temperature changes rapidly. In addition, measurement errors will result when using thermocouples. In this case, let the DX100L adjust to the new environment for at least one hour before using the DX100L.
- The lifetime of the LCD may be shortened if the DX100L is used in a high-temperature environment over a long period of time. When installing the DX100L in a high-temperature environment (greater than 40°C), we recommend the backlight brightness of the LCD be set to a low setting. For setting the LCD brightness, see section 7.14.

Do not install the DX100L in the following places:

- **Outdoors**
- **In direct sunlight or near heat sources**
Install the DX100L in a place with small temperature fluctuations near room temperature (23°C). Placing the DX100L in direct sunlight or near heat sources can cause adverse effects on the internal circuitry.
- **Where an excessive amount of soot, steam, moisture, dust, or corrosive gases are present**
Soot, steam, moisture, dust, and corrosive gases will adversely affect the DX100L. Avoid such locations.
- **Near strong magnetic field sources**
Do not bring magnets or instruments that produce electromagnetic fields close to the DX100L. Operating the DX100L in strong magnetic fields can cause errors in the measurements.
- **Bad angle for viewing the screen**
Because the DX100L uses a 5.5” TFT color LCD, it is difficult to view the display from an extreme angle. Please install the DX100L so that the monitor can be viewed from the front.

2.2 Installing the DX100L

Installation Procedure (Panel Mount Type)

The DX100L should be mounted on a steel panel of thickness 2 mm to 26 mm.

1. Insert the DX100L from the front side of the panel.
2. As shown in the figure below, mount the DX100L to the panel using the mounting brackets that came with the package.
 - The proper torque for tightening the mounting screws is 0.8 to 1.2 N·m.
 - For the DX100L-2: attach a mounting bracket to the top and bottom of the instrument (after peeling off the seals covering the mounting bracket holes in the case).
 - For the DX100L-3: attach one mounting bracket to the top of the instrument (after peeling off the seals covering the mounting bracket holes in the case).

CAUTION

Tightening the screws too much can deform the case or damage the bracket.

Panel Mounting the DX100L-2

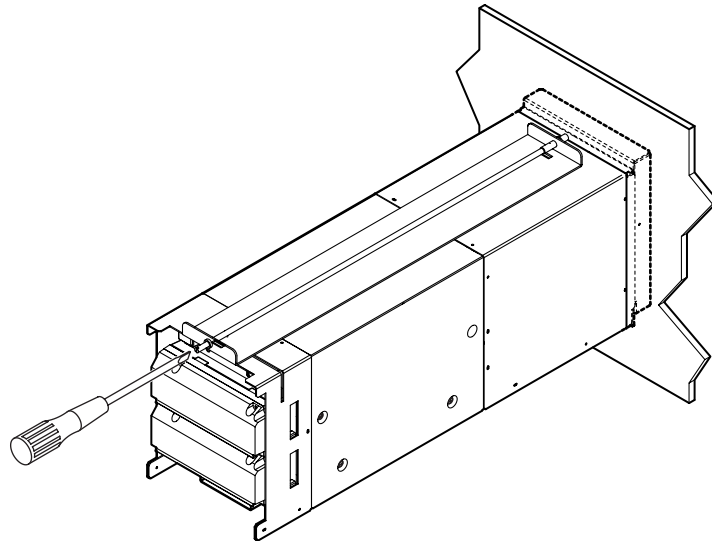

Panel Mounting the DX100L-2

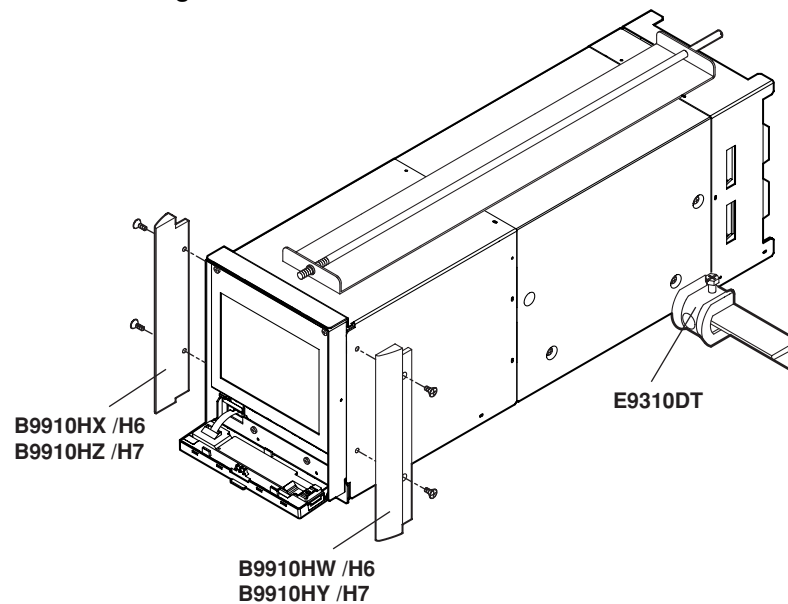

For panel cutout and external dimensions, see section 14.8, "External Dimensions"

2.3 Input Signal Wiring



CAUTION

- If a strong tension is applied to the cable wired to the DX100L, the terminals of the DX100L and/or the cable can be damaged. In order to prevent tension from being applied directly on the terminals, fasten all wiring cables to the rear of the mounting panel.
- To prevent fire, use signal wires having a temperature rating of 70°C or more.

Precautions to be taken while wiring

Take the following precautions when wiring the input signal cables.

- **It is recommended that crimp-on lugs (designed for 4 mm screws) with insulation sleeves be used on the lead wire ends. However, this does not apply to the optional clamped terminals (optional code /H2).**

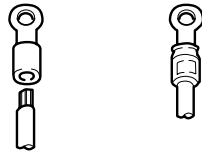

Crimp-on lug

- **Take measures to prevent noise from entering the measurement circuit.**
 - Move the measurement circuit away from the power cable (power circuit) and ground cable.
 - It is desirable that the item being measured does not generate noise. However, if this is unavoidable, isolate the measurement circuit from the item. Also, ground the item being measured.
 - Shielded wires should be used to minimize noise caused by electrostatic induction. Connect the shield to the ground terminal of the DX100L as necessary (make sure you are not grounding at two points).
 - To minimize noise caused by electromagnetic induction, twist the measurement circuit wires at short, equal intervals.
 - Make sure to earth ground the protective ground terminal through minimum resistance (less than 100 Ω).
- **When using internal reference junction compensation on the thermocouple input, take measures to stabilize the temperature at the input terminal.**
 - Always use the input terminal cover.
 - Do not use thick wires which may cause large heat dissipation (cross sectional area 0.5 mm² or less recommended).
 - Make sure that the ambient temperature remains reasonably stable. Large temperature fluctuations can occur if a nearby fan turns ON or OFF.
- **Connecting the input wires in parallel with other devices can cause signal degradation, affecting all connected devices.**

If you need to make a parallel connection, then

 - Turn the burnout function OFF. (See section 5.9)
 - Ground the instruments to the same point.
 - Do not turn ON or OFF another instrument during operation. This can have adverse effects on the other instruments.
 - RTDs cannot be wired in parallel.



WARNING

To prevent electric shock, ensure the main power supply is turned OFF.



CAUTION

- Do not apply input signals that exceed the following values. This can damage the DX100L.
 - Maximum input voltage
 - Voltage range of 2 VDC or less or thermocouples: ± 10 VDC
 - Voltage range between 6 and 50 VDC: ± 60 VDC
 - Maximum common mode noise voltage
 - 250 VACrms (50/60Hz)
 - The DX100L is an INSTALLATION CATEGORY II product.
-

Wiring Procedure

1. Turn OFF the DX100L and remove the input terminal cover.
2. Connect the input signal wires to the input terminals.
3. Replace the input terminal cover and fasten it with screws.

Note

- For clamped input terminals, the following wires are recommended.
 - Cross sectional area of the conductor or conductors
 - Single conductor: 0.14 mm^2 to 1.5 mm^2
 - Stranded conductors: 0.14 mm^2 to 1.0 mm^2
 - Stripped cable length: approximately 5 mm
 - Input signal wires of diameter less than or equal to 0.3 mm may not be secured firmly for clamped input terminals. Fold over the conducting section of the wire, for example, to make sure that the wire is securely connected to the clamped input terminal.
-

DX102L/DX104L

• **Input Terminal Position**

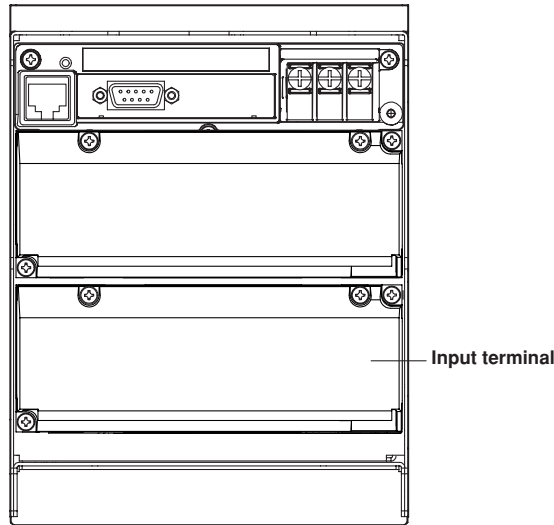

• **Terminal Arrangement**

DX102L/DX104L

Standard Input Terminals

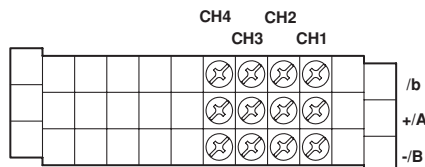

Clamped Input Terminals (/H2)

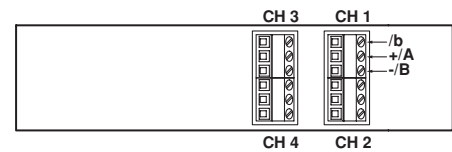

DX106L

Standard Input Terminals

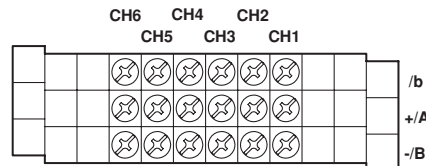

Clamped Input Terminals (/H2)

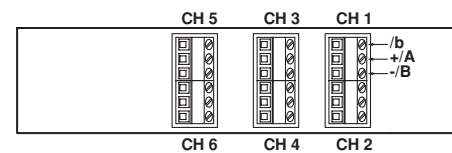

DX112L

Standard Input Terminals

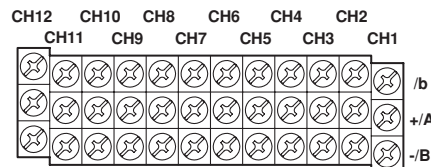

Clamped Input Terminals (/H2)

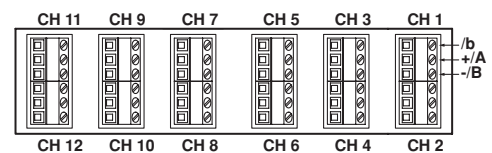

Note

RTD input terminals A and B are isolated on each channel. Terminal b is shorted internally across all channels. However, for options /N1 (Cu10, Cu25 RTD input, 3 terminal isolated RTD) and /N2 (3 terminal isolated RTD), input b is isolated for each channel.

2.3 Input Signal Wiring

• Wiring Diagram

DC Voltage and DI Input

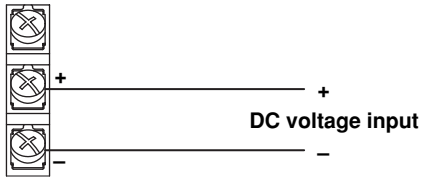

Thermocouple Input

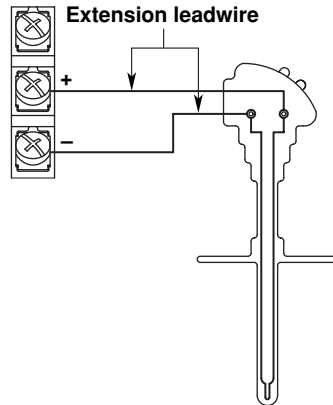

Resistance Temperature Detector Input

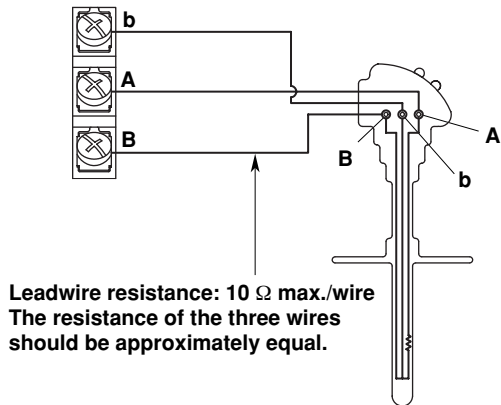

DC Current Input

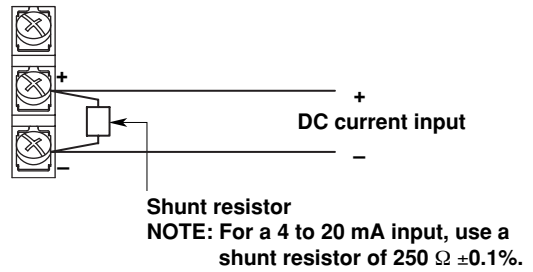

2.4 Alarm Output Wiring (/AR1, /AR2, /A3 Option)



WARNING

- To prevent electric shock, ensure the main power supply is turned OFF.
- If a voltage of more than 30 VAC or 60 VDC is to be applied to the alarm output terminal, use ring-tongue crimp-on lugs with insulation sleeves on all terminals to prevent the wires from slipping out when the screws become loose. Furthermore, use double-insulated wires (dielectric strength of 2300 VAC or more) for the signal wires on which a voltage of more than 30 VAC or 60 VDC is to be applied. For all other wires, use basic insulated wires (dielectric strength of 1350 VAC). To prevent electric shock, attach the terminal cover after wiring and make sure not to touch the terminals.



CAUTION

- To prevent fire, use signal wires having a temperature rating of 70°C or more.
- Use the following circuit voltage for the connection to the alarm output terminal.
 - When the connection is to Mains Circuits (primary AC power source circuits): 150 V or less
 - When the connection is to circuits derived from Mains Circuits (secondary circuits): 250 V or less(Mains Circuits voltage is less than 300 V, and connection must be used by isolation transformer.)

Wiring Procedure

1. Turn OFF the DX100L and remove the cover for the option terminal.
2. Connect the alarm output cables to the terminal.
The terminal arrangement will be one of the figures shown on the next page depending on the alarm output relay option (number of outputs).
3. Replace the terminal cover and fasten it with screws.

2.4 Alarm Output Wiring (/AR1, /AR2, /A3 Option)

Alarm Terminal Position

Enclosed in parentheses are the relay numbers assigned to each option terminal.

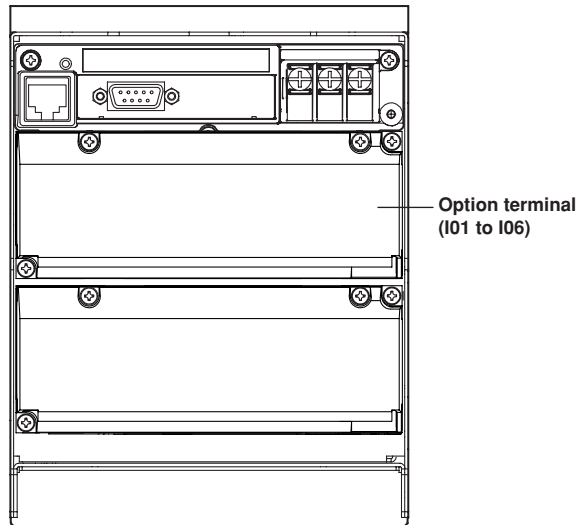

Terminal Arrangement (Only the position of the alarm output terminals is indicated.)

When the relay is not energized, NC is closed and NO is open. C is the common terminal.

- /AR1, /AR1/F1

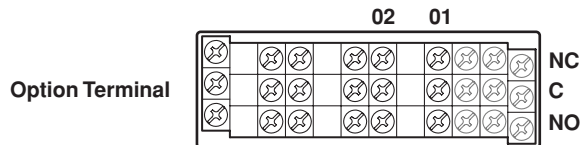

- /AR2, /AR2/F1

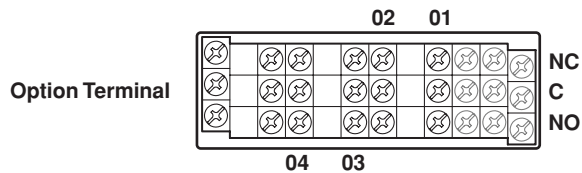

- /A3, /A3/R1

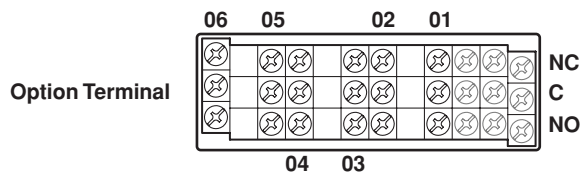

Contact Specifications

Item	Specification
Output type	Relay transfer contact (energize/de-energize switchable)
Output capacity	250 VAC (50/60 Hz), 3 A 250 VDC, 0.1 A (resistive load)
Dielectric strength	1500 VAC (50/60 Hz) for one minute between output terminals and the ground terminal

For details related to the switching of energized/de-energized state of the alarm relays, see section 6.4.

2.5 FAIL/Memory End Wiring (/F1 Option)



WARNING

- To prevent electric shock, ensure the main power supply is turned OFF.
- If a voltage of more than 30 VAC or 60 VDC is to be applied to the FAIL/Memory End output terminal, use ring-tongue crimp-on lugs with insulation sleeves on all terminals to prevent the wires from slipping out when the screws become loose. Furthermore, use double-insulated wires (dielectric strength of 2300 VAC or more) for the signal wires on which a voltage of more than 30 VAC or 60 VDC is to be applied. For all other wires, use basic insulated wires (dielectric strength of 1350 VAC). To prevent electric shock, attach the terminal cover after wiring and make sure not to touch the terminals.



CAUTION

- To prevent fire, use signal wires having a temperature rating of 70°C or more.
- Use the following circuit voltage for the connection to the FAIL/Memory End output terminal.
 - When the connection is to Mains Circuits (primary AC power source circuits): 150 V or less
 - When the connection is to circuits derived from Mains Circuits (secondary circuits): 250 V or less
(Mains Circuits voltage is less than 300 V, and connection must be used by isolation transformer.)

Wiring Procedure

1. Turn OFF the DX100L and remove the cover for the option terminal.
2. Connect the FAIL/Memory End output cables to the terminal.
The terminal arrangement for the FAIL/Memory End output option is as follows.

Terminal Position

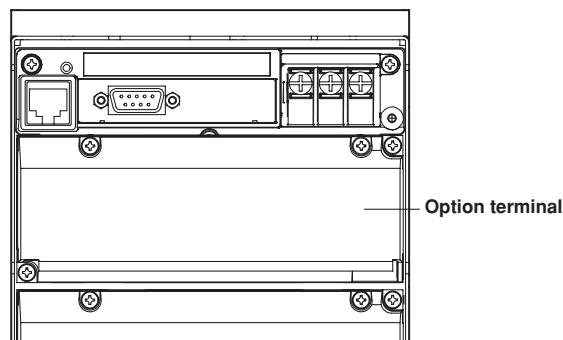

2.5 FAIL/Memory End Wiring (/F1 Option)

Terminal Arrangement (Only the position of the FAIL/Memory End output terminals is indicated.)

When the relay is not energized, NC is closed and NO is open. C is the common terminal.

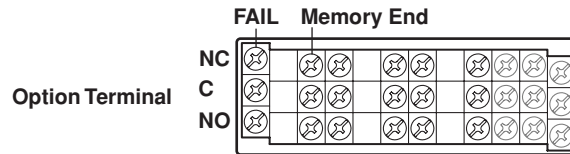

3. Replace the terminal cover and fasten it with screws.

Note

FAIL output is a de-energize relay (de-energized on failure), and the memory end output is an energize relay (energized on memory end).

Contact Specifications

Item	Specification
Output type	Relay transfer contact
Output capacity	250 VAC (50/60 Hz), 3 A 250 VDC, 0.1 A (resistive load)
Dielectric strength	1500 VAC (50/60 Hz) for one minute between output terminals and the ground terminal

For details related to the FAIL/Memory End output, see section 1.8.

2.6 Remote Control Wiring (/R1 Option)

WARNING

To prevent electric shock, ensure the main power supply is turned OFF.



CAUTION

To prevent fire, use signal wires having a temperature rating of 70°C or more.

Wiring Procedure

1. Turn OFF the DX100L and remove the cover for the option terminal.
2. Connect the remote control signal cables to the terminal.
The terminal arrangement for the remote control option is as follows.

Terminal Position

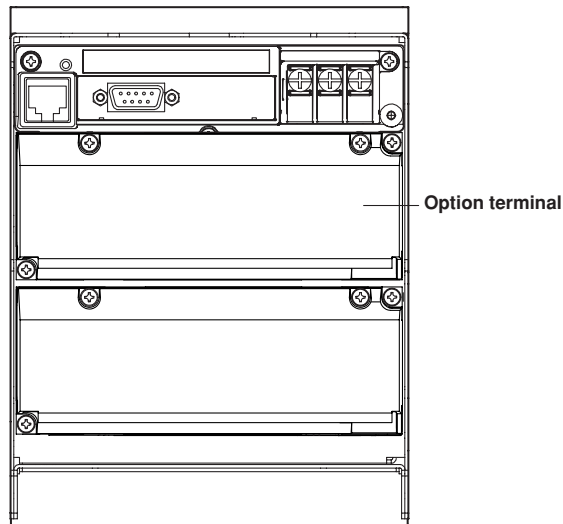

Terminal Arrangement (Only the position of the remote control terminals is indicated.)

C is a common terminal for terminals 1 through 8.

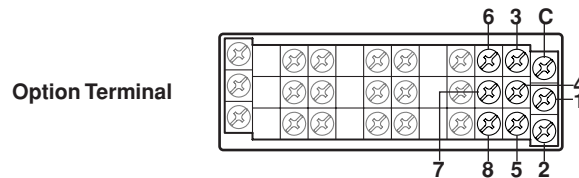

3. Replace the terminal cover and fasten it with screws.

Note

Use shielded wires for the remote control wires to reduce the effects of noise. Connect the shield to the ground terminal of the DX100L.

2.6 Remote Control Wiring (/R1 Option)

Input Specifications

Item	Specification
Input signal	Voltage-free (dry) contact, open-collector (TTL or transistor)
Input conditions	ON voltage: Less than or equal to 0.5 V (30 mA DC) Leakage current in the OFF state: No more than 0.25 mA Signal duration: 250 ms minimum
Input type	Photocoupler isolation (one side common) Internal isolated power source (5 V \pm 5%)
Dielectric strength	500 VDC for one minute between input terminals and the ground terminal

For details related to the control and input types, see section 10.9.

2.7 24 VDC Transmitter Power Supply Wiring (/ TPS2, /TPS4, Option)



WARNING

To prevent electric shock, ensure the main power supply is turned OFF.



CAUTION

- Never short-circuit the power supply terminals or apply an external voltage, otherwise damage to the DX100L may result.
- Do not use current that exceeds the maximum output current (25 mADC). This may cause damage to the DX100L.
- To prevent fire, use signal wires having a temperature rating of 70°C or more.

Wiring diagram

Arrange the wires as shown below.

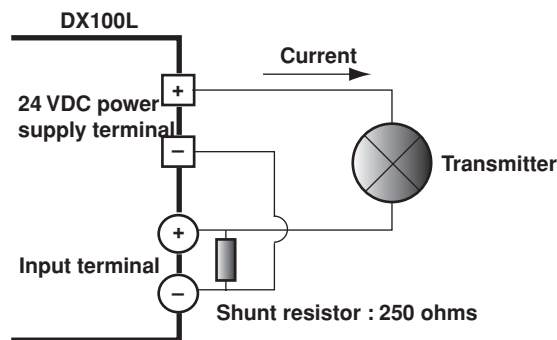

Wiring Procedure

1. Turn OFF the DX100L and remove the cover for the option terminal.
2. Connect the 24 VDC power supply wires to the terminal.

The terminal arrangement for the 24 VDC power supply option is as follows.

Terminal Position

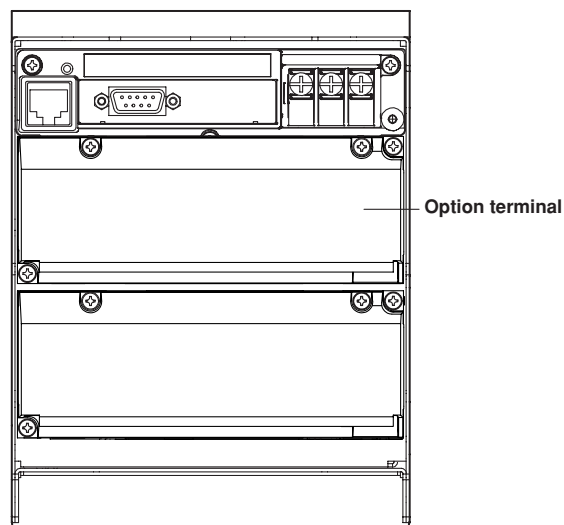

2.7 24 VDC Transmitter Power Supply Wiring (/TPS2, /TPS4, Option)

- /TPS2

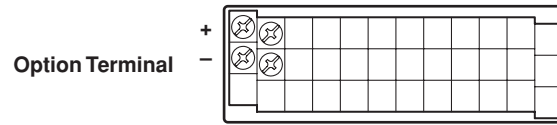

- /TPS4

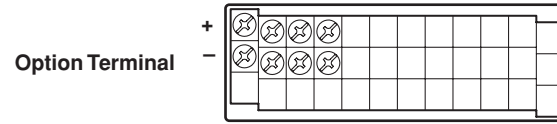

Note

Use shielded wires to reduce the effects of noise. Connect the shield to the ground terminal of the DX100L.

2.8 Power Supply Wiring

For the Panel Mount Type

Precautions to be taken when wiring the power supply

To prevent electric shock and damage to the DX100L, observe the following warnings.



WARNING

- To prevent electric shock, ensure the main power supply is turned OFF.
- To prevent the possibility of fire, use 600 V PVC insulated wire (AWG18) or an equivalent wire for power wiring.
- Make sure to earth ground the protective earth terminal through a grounding resistance less than 100 Ω before turning ON the power.
- Use crimp-on lugs (designed for 4 mm screws) for power and ground wiring termination. (See section 2.3, "Input Signal Wiring")
- To prevent electric shock, make sure to attach the transparent terminal cover.
- Make sure to provide a power switch (double-pole type) on the power supply line in order to separate the DX100L from the main power supply. Put an indication on this switch as the breaker on the power supply line for the DX100L.

Switch Specification

Rated power current: 1 A or more (except for /P1 model), 3 A or more (for /P1 model)

Rated rush current: 60 A or more (except for /P1 model), 70 A or more (for /P1 model)

Use a switch complied with IEC60947-1, 3.

- Connect a fuse (between 2 A and 15 A) to the power line.
The power switch and fuse used on the power supply line should be
 - CSA approved (for the use in North America) or
 - VDE approved (for the use in Europe).
- Do not add a switch or fuse to the ground line.

Use a power supply that meets the following conditions:

Item	except for /P1 model	for /P1 model
Rated power supply	100 to 240 VAC	24 VDC/AC
Allowable power supply voltage range	90 to 132 or 180 to 264 VAC	21.6 to 26.4 VDC/AC
Rated power supply frequency	50/60 Hz	50/60 Hz (for AC)
Allowable power supply frequency range	50/60 Hz \pm 2%	50/60 Hz \pm 2% (for AC)
Maximum power consumption	45 VA (100 V), 62 VA (240 V)	30 VA (for DC), 45VA (for AC)

Note

Do not use a supply voltage in the range 132 to 180 VAC, as this may have adverse effects on the measurement accuracy (applies to all models except the ones with the /P1 option).

Wiring Procedure

1. Turn OFF the DX100L and remove the transparent power terminal cover.
2. Connect the power supply wires and the protective ground wire to the power terminals. The proper torque for tightening the screw is 1.4 to 1.5 N·m (12.4 to 13.2 inch·lbs).

2.8 Power Supply Wiring

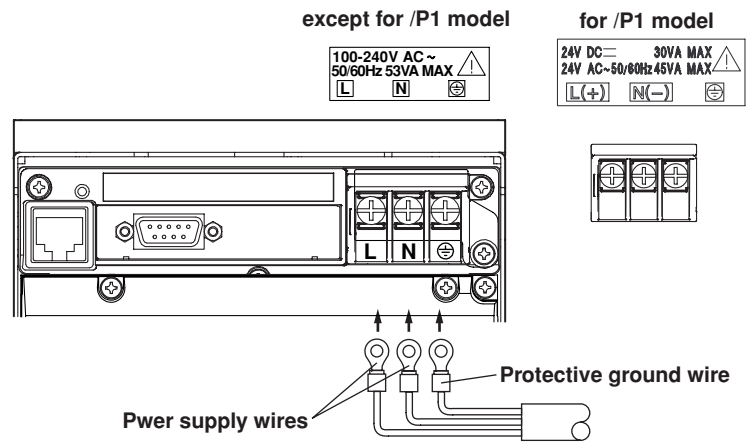

3. Replace the power terminal cover, and fasten it with screws.

3.1 Names of Parts and Functions

Front Panel

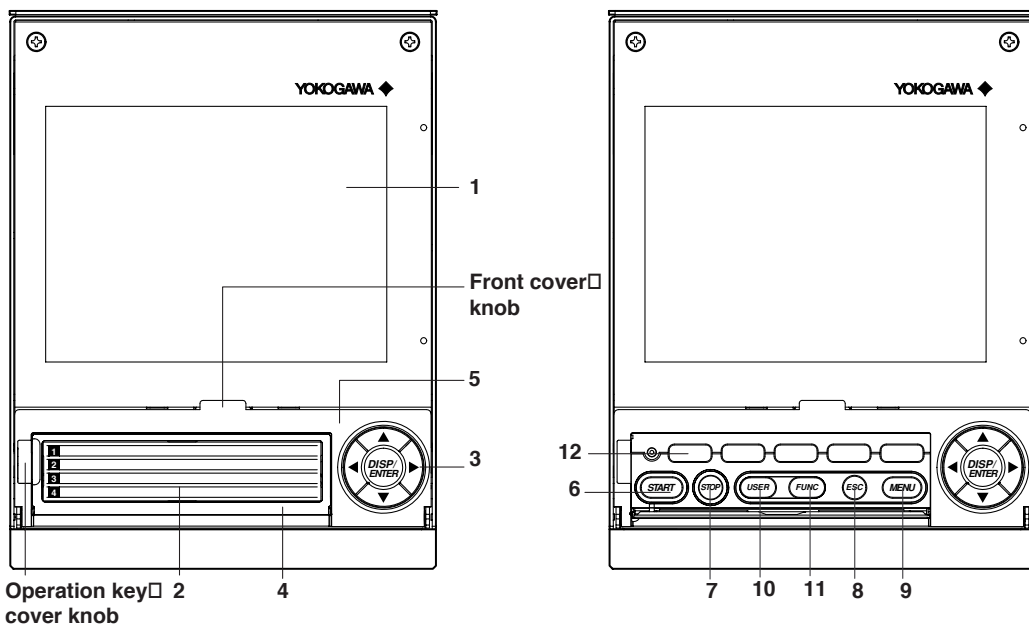

1. **LCD screen**
Displays various operation screens such as the trend display and the setup screen to configure the DX100L.
2. **Label**
A label used to distinguish the channels. The user can write on this label and use it as a reference.
3. **Operation key**
Left, right, up, and down arrow keys and the DISP/ENTER key.
The keys are used to switch the operation screen in the operation mode. In the setup screens, the keys are used to select parameters and to confirm the new settings.
4. **Key panel cover**
Open this cover to access the keys besides the arrow keys and the DISP/ENTER key. Open the cover by pulling the tab on the upper left corner of the cover toward you.

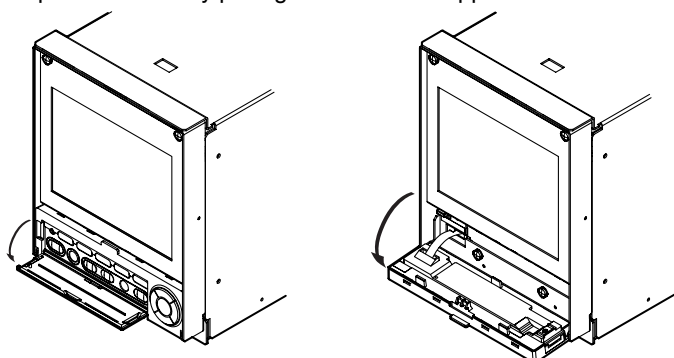

5. **Front cover**
Open the front cover when turning ON/OFF the DX100L or inserting or removing the external storage medium such as the floppy disk. Open the cover by pushing down on the tab located at the center of the top edge of the cover and pulling it forward. Keep the cover closed at all times except when accessing the power switch and the external storage medium.

3.1 Names of Parts and Functions

Note

For DX100Ls which are side-by-side mounted vertically, when a front panel is opened the down arrow key may interfere the upper front panel.

6. START key

Used to start the data acquisition to the internal memory and display the waveform on the trend display. Also starts computation and the report function when the computation function (/M1) is equipped.

7. STOP key

Used to stop the data acquisition to the internal memory. It also stops the updating of the waveform on the trend display. If the model has the optional computation function (/M1), the report is stopped. For computation, you can select whether or not to stop the operation when the STOP key is pressed.

8. ESC key

Used to cancel an operation. Also used to return to the operation mode from the setting mode.

9. MENU key

Used to enter the setting mode. Also used to return to the operation mode from the setting mode.

10. USER key

Executes the action assigned to this key.

11. FUNC key

Used to execute various functions in the operation mode. For the functions that you can execute, see section 3.4. Also, used to enter the basic setting mode from the setting mode.

12. Soft keys

When the FUNC key is pressed, the functions are assigned to the soft keys and displayed at the bottom of the screen.

During the setting/basic setting modes, the parameters are assigned to the soft keys and displayed at the bottom of the screen.

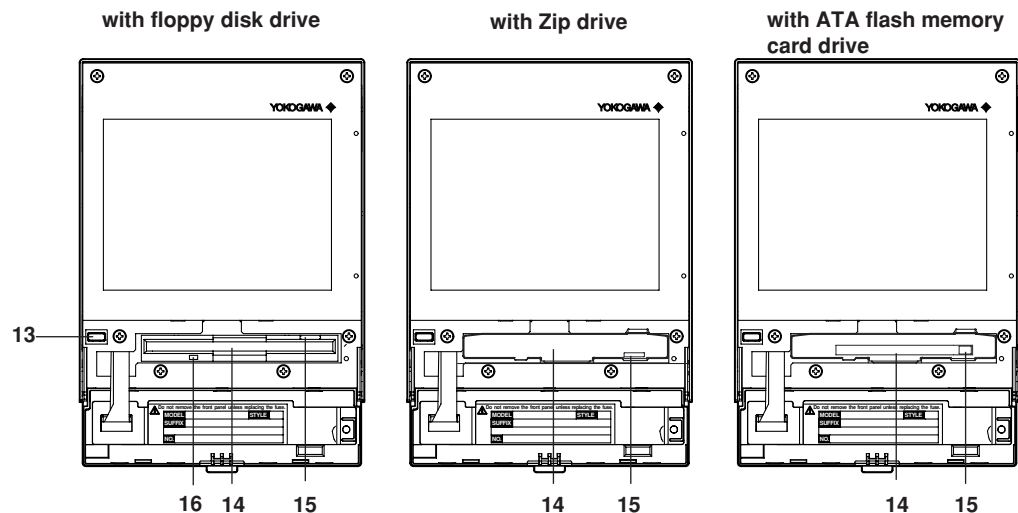

13. Power switch

14. Storage medium drive

Floppy disk drive, Zip drive, or ATA flash memory card drive depending on the specification.

15. Eject button (Access lamp for Zip drive)

Used when ejecting the storage medium. Also is the access lamp for the Zip drive. The access lamp is lit while the Zip disk is being accessed.

16. Access lamp for the floppy disk drive

The access lamp is lit while the floppy disk is being accessed.

Rear Panel

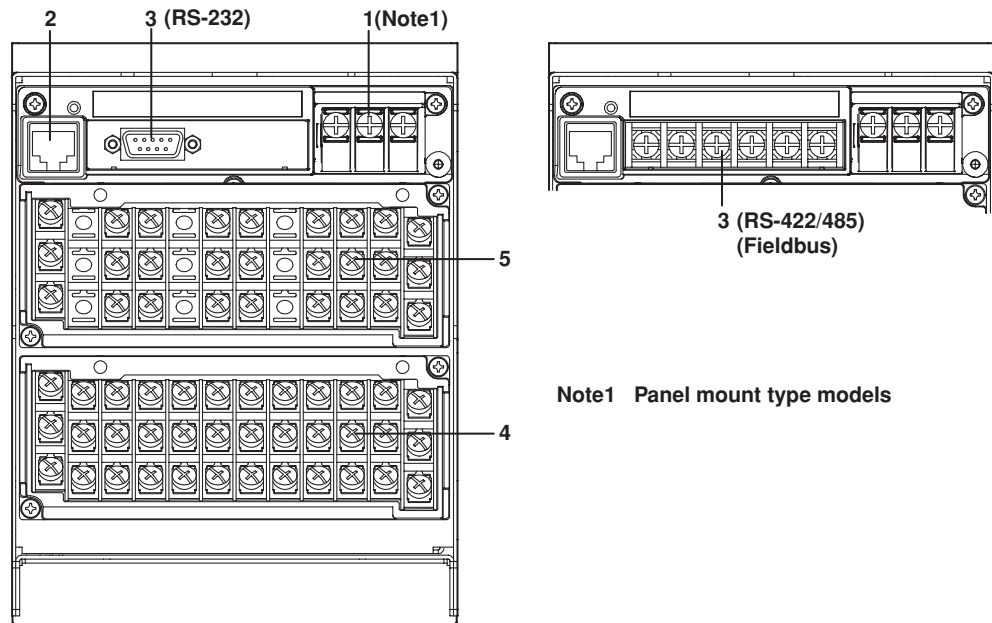

Note1 Panel mount type models

1. **Power terminals and a protective ground terminal**
Connect the power cord and the protective ground cord.
2. **Ethernet port**
Connect the Ethernet cable (10Base-T).
3. **Serial interface port (/C2, /C3 option) or fieldbus interface port (/CF1 option)**
RS-232 port or RS-422/485 port or FOUNDATION Fieldbus port depending on the specification. Connect the interface cable.
4. **Input terminals**
Connect the input signal cable of the item being measured.
5. **Option terminals (/AR1, /AR2, /A3, /F1, /R1, /TPS2, /TPS4 option)**
Connect optional input/output signal cables.
6. **Functional ground terminal**

Note

See the DX100/DX200 Communication Interface User's Manual (IM 04L02A01-17E) to use Ethernet port and the serial interface port.

3.2 Turning ON/OFF the Power Switch

This section describes the procedures to turn ON/OFF the power switch.

Procedure

Turning ON the power

1. Check the following points before turning ON the power switch.
 - The power cord/wires are connected correctly to the DX100L.
 - The DX100L is connected to the correct power supply (see section 2.7).
 - The proper fuse is set (see section 13.4).

CAUTION

If the input wires are connected in parallel with another instrument, avoid turning ON/OFF the DX100L or the other instrument when either one is in operation. This may affect the reading.

2. Open the front cover by pressing down on the knob that is located in the center of the upper section of the cover and pulling forward.
3. Turn the power switch ON.
4. Close the cover.

After performing a self-diagnosis for a few seconds, a screen in the operation mode appears.

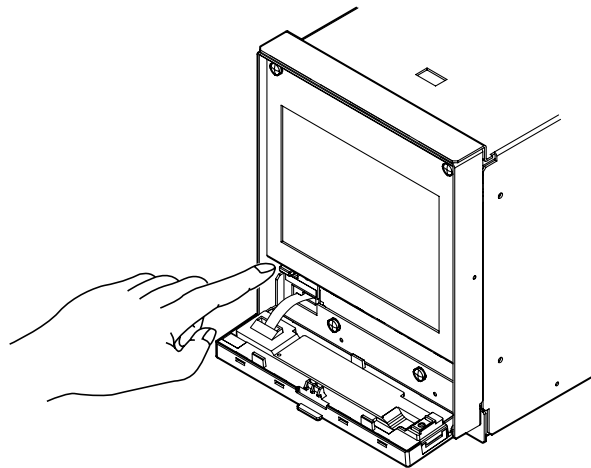

Turning OFF the power

1. Check that the external storage medium is not being accessed and turn OFF the power switch.

Note

- If nothing is displayed when the power switch is turned ON, turn OFF the power switch and check the points listed in step 1. After checking the points, turn ON the power switch again. If the unit still does not work, it is probably malfunctioning. Contact your nearest YOKOGAWA dealer for repairs.
- If an error message is displayed on the screen, take measures according to the description in chapter 12, "Troubleshooting."
- Turn ON the power switch, let the DX100L warm up for at least 30 minutes, and then start the measurements.

3.3 Inserting/Removing the External Storage Medium

This section describes the procedures to insert and remove the external storage medium. Three types of media can be used depending on the specification.

- Model DX1 **L-1: Floppy disk
- Model DX1 **L-2^{*2} or DX1 **L-5^{*2}: Zip disk^{*1}
- Model DX1 **L-3: ATA flash memory card

For the handling procedure of the storage medium, see section 2.1.

^{*1} Only 100 MB Zip disks can be used with model DX1 **L-2. With model DX1 **L-5, 250 MB and 100 MB Zip disks can be used. However, 100 MB Zip disks must be formatted using quick (logical) formatting rather than normal (physical) formatting.

^{*2} This product is no longer produced.

Procedure

Inserting the storage medium

1. Open the front cover by pressing down on the knob that is located in the center of the upper section of the cover and pulling forward. Insert the medium into the drive until a click is heard.
2. When the power switch is turned ON, closing the front cover causes the DX100L to detect the existence of an external storage medium in the drive. If the storage medium is detected, an external storage medium icon is displayed in the status display section of the screen

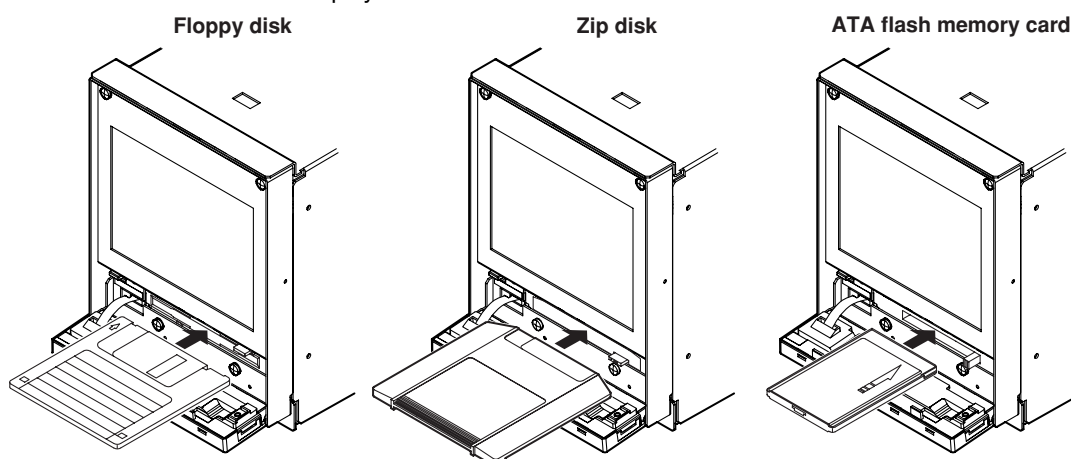

Note

Keep the front cover closed during operation except when accessing the power switch and the external storage medium. This will protect the storage medium and the drive from foreign particles such as dust.

Removing the storage medium

Floppy disks and ATA flash memory cards can be removed from the drive regardless of whether the DX100L is turned ON or OFF. Zip disks cannot be removed when the DX100L is turned OFF.

1. If the DX100L is turned ON, check that the storage medium is not being accessed.

Note

- The access lamp is lit while the storage medium is being accessed.
- A message "Data are being saved to the medium." is displayed while measured/computed data are being saved to the medium.

3.3 Inserting/Removing the External Storage Medium

2. Open the front cover by pressing down on the knob that is located in the center of the upper section of the cover and pulling forward. Push the eject button to remove the storage medium.
3. Close the front cover. If the DX100L is turned ON, the external storage medium icon in the status display section disappears.

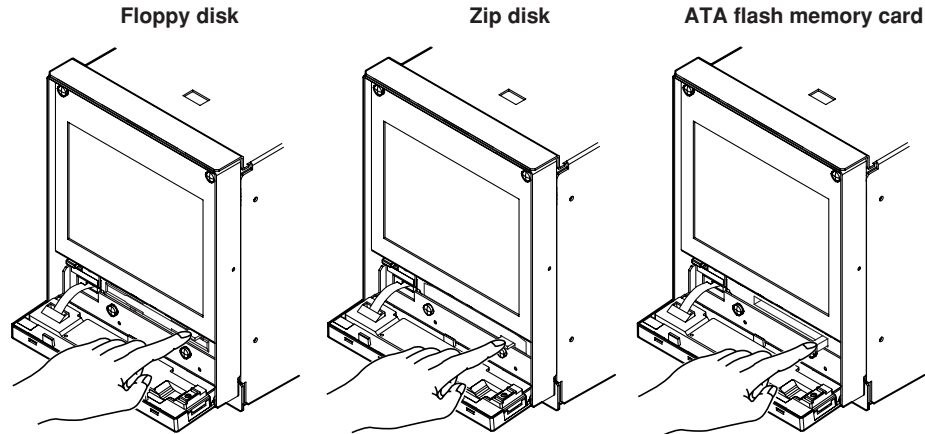

Note

If the key lock function for the storage medium is engaged, the Zip disk cannot be ejected even if the eject button is pressed. Release the key lock before attempting to eject the Zip disk. See section 10.4.

Procedure when the Zip disk cannot be ejected

If the Zip disk cannot be removed by performing the steps given in the "Removing the storage medium" section, carry out the following steps to remove it.

1. Open the front cover by pressing down on the knob that is located in the center of the upper section of the cover and pulling forward.
2. Insert a pin of approx. 1 mm in diameter into the eject button hole and press slowly. This will cause the Zip disk to be ejected.

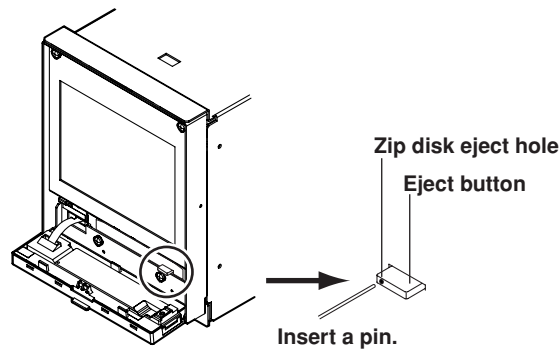

Explanation

Formatting external storage media

Format the external storage medium before use.

The external storage medium is formatted to the following types using the DX100L.

Format type

- | | |
|------------------------|--------------------------------------|
| Floppy disk: | 2 HD, 1.44 MB |
| Zip disk: | FDISK 1 partition (hard disk format) |
| ATA flash memory card: | FDISK 1 partition (hard disk format) |

External storage media formatted on other devices can be used as long as the format type is the same as those indicated above.

3.4 Run Mode

There are three run modes on the DX100L: operation, setting, and basic setting. This section describes the functions and relationships of the three modes.

Mode Types

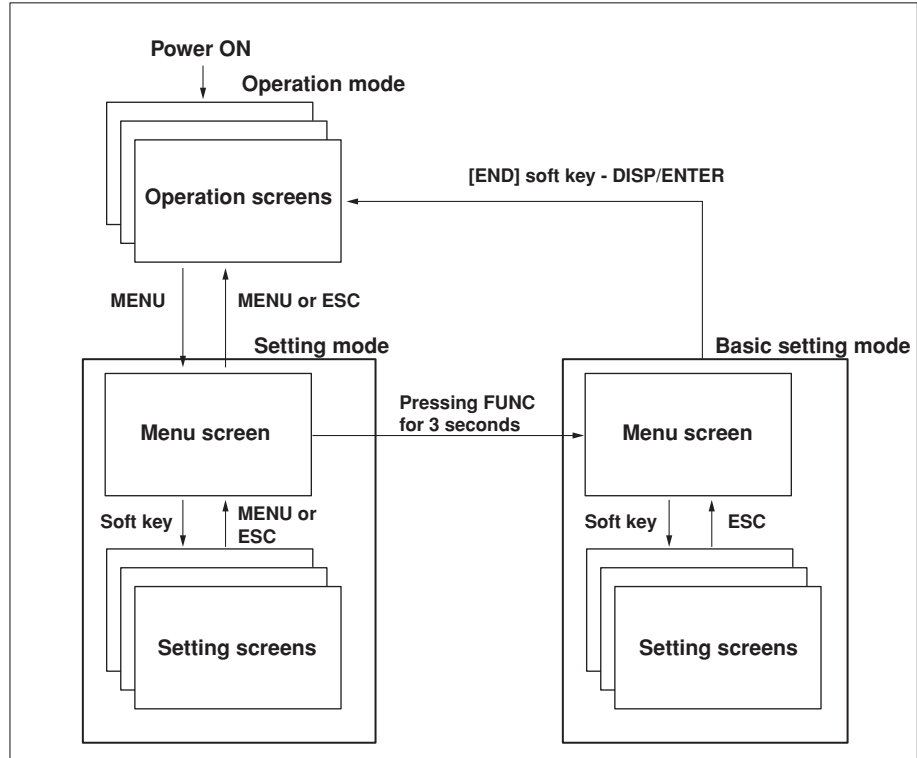

Mode Type	Description	Possible Operations
Operation mode	This mode is used for daily operation. This mode is entered when the power is turned ON.	Monitoring operation Data acquisition
Setting mode	This mode is used to configure the DX100L operation such as input range and alarms. This mode is entered by pressing the MENU key in the operation mode. Measured data cannot be displayed in this mode. Operations such as measurements, alarm detection, and data acquisition are continued.	Setting the operation Operation related to the file on the external storage medium
Basic setting mode (Setup mode)	This mode is used to configure the basic environment of the DX100L such as the input format and the data storage format. This mode is entered by pressing the FUNC key for three seconds at the setting mode menu. This mode cannot be entered while data acquisition or computation is in progress. Operations such as measurements, alarm detection, and data acquisition are stopped.	Basic settings of the functions Operation related to the file on the external storage medium

Functions and Operations in the Operation Mode

Operation screen

Displays various operation screens such as trend, digital, bar graph, alarm summary, message summary, memory summary, historical trend, and report display (option). Screens are switched by the arrow keys and the DISP/ENTER key. See chapter 4.

Operations using the FUNC key

Pressing the FUNC key displays a menu that is assigned to the soft keys at the bottom of the screen. The menu varies depending on the setup information and options. Press the [Next] soft key to display the soft key menu in the next line.

The function is executed by pressing the soft key. Press the FUNC or ESC key to erase the menu without executing the assigned function.

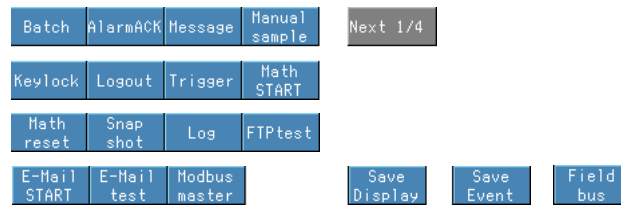

FUNC key menu

Menu	Ref. section	Description
Batch	10.11	Displays the batch screen (for models with /BT1).
Alarm ACK	6.1, 6.4	Release alarm indication and relay output (when alarm display and alarm output relay action is set to "hold.")
Message	7.4	Displays messages and stores them to the internal memory.
Manual sample	8.12	Stores instantaneous values of all channels to the internal memory.
Key lock	10.3	Enables or disables key lock. (when key lock is in use)
Logout	10.5	Logout (when being logged in while key login is in use)
Trigger	8.6, 8.11	Starts acquiring event data (when [Key Trigger] is set as a trigger to start acquiring event data)
Math START/STOP	11.3	Starts/stops computation. (when the computation function (/M1) is equipped)
Math reset	11.3	Clears computed results. (when the computation function (/M1) is equipped and the computation is suspended)
Math ACK	11.3	Clears the computation dropout display. (when the computation function (/M1) is equipped and the computation dropout occurs)
Snapshot	9.6	Saves the screen image data to the external medium.
Log	10.7	Displays log screens or the system information screen.
FTP test ^{*1}		Executes FTP test.
Save Display/Save Event	8.7	Stores the display data or event data to the external storage medium. (only when the display data or event data (free mode) are being acquired to the internal memory).
E-Mail START/STOP ^{*1}		Starts/stops E-mail transmission.
E-Mail test ^{*1}		Executes E-mail test.
Modbus master ^{*1}		Displays the Modbus status screen.
Fieldbus ^{*2}		Displays the fieldbus status screen.

*1 See the DX100/DX200 Communication Interface User's Manual (IM 04L02A01-17E).

*2 See the Fieldbus Communication Interface User's Manual (IM 04L02A01-18E).

Other key operations**• START/STOP**

Starts/stops acquiring measured/computed data. For the operating procedure, see sections 8.5 and 8.6.

The waveform on the trend display also starts/stops.

When the computation function (/M1) is equipped, computation and the report function also start/stop. For the operating procedure, see sections 11.3 and 11.12.

• USER

Executes the assigned function. See section 10.1.

Functions of the Setting and Basic Setting Modes

Configure functions using the arrow keys, the DISP/ENTER key, the soft keys, and the character/number input keys. See “3.5 Configuring the functions” and chapters 5 through 11 for detail. Also see section 9.1 to save the setup data.

3.5 Configuring the Functions (Setting Mode and Basic Setting Mode)

Setting Mode and Basic Setting Mode

Basic Setting Mode

The basic setting mode is used to change the basic configuration of various functions. The basic setting mode cannot be entered while data acquisition or computation is in progress or the storage medium is being accessed.

Setting Mode

The setting mode is used to change the functions for each channel and the display specifications. All items except the ones listed below can be changed while data acquisition or computation is in operation. Items that cannot be changed are grayed and the cursor cannot be moved on them.

- **Items that cannot be changed while data acquisition is in progress**
 - Input range
 - Display update rate for the trend display
 - Auto save interval
 - Computing equation
 - Constants for computation
- **Items that cannot be changed while computation is in progress.**
 - Range setting
 - Computing equation
 - Constants for computation
 - TLOG timer number and sum scale

Configuration Details

The configuration details of the setting mode and the basic setting mode are shown below. Enclosed in parentheses are reference sections.

Settings related to the input

Item	Setting Mode	Basic Setting Mode
Scan interval (5.9)		<ul style="list-style-type: none"> • Scan interval
Input specifications (5.1 to 5.7)	<ul style="list-style-type: none"> • Input type • Measurement range • Upper and lower limit of span • Reference channel for differential computation • Upper and lower limits of scale • Unit 	
Burnout (5.9)		<ul style="list-style-type: none"> • Burn out Off/Up/Down
Reference junction compensation (5.9)		<ul style="list-style-type: none"> • Switch between [Internal] and [External] • Compensation voltage when set to [External]
Noise elimination	<ul style="list-style-type: none"> • Filter time constant/Off (DX102L/DX104L) (5.8) • Number of samples for the moving average/Off (DX106L/DX112L) (5.8) 	<ul style="list-style-type: none"> • Integration time of the A/D converter (5.9)

Settings related to the alarm

Item	Setting Mode	Basic Setting Mode
Alarm	<ul style="list-style-type: none"> • Alarm type (6.2) • Alarm value (6.2) • Output relay On/Off (6.2) • Output relay number (6.2) • Alarm delay time (6.3) 	<ul style="list-style-type: none"> • Display hold/non-hold (6.4) • The time interval for the rate-of-change alarm (for measurement channels only) (6.4) • Hysteresis (for measurement channels only) (6.4)
Alarm output relay operation (option) (6.4)		<ul style="list-style-type: none"> • Reflash alarm • AND operation • Relay energize/de-energize • Relay hold/non-hold

Settings related to the display

Item	Setting Mode	Basic Setting Mode
Display group	<ul style="list-style-type: none"> • Group name (7.6) • Channel assignment (7.6) • Group display switching interval (7.13) 	
Tag/Channel display	<ul style="list-style-type: none"> • Tag name (7.1) 	<ul style="list-style-type: none"> • Switch between tag display and channel number display (7.2)
Trend	<ul style="list-style-type: none"> • Display rate (7.3) • Message (7.5) • Trip line position, display color (7.7) • Trip line width (7.13) • Channel display color (7.8) (applies also to bar graphs) • Display direction (vertical/horizontal) (7.13) • Trend line width (7.13) • Grid (7.13) • Scale value digits (7.13) • Number of scale divisions (7.10) (applies also to bar graphs) • Scale position (7.10) • Zone upper and lower limits (7.9) • Partial expanded display (7.11) 	<ul style="list-style-type: none"> • Measurement channels to display the trend (applies also to measurement channels that data are to be acquired) (8.10) • Use/not use the partial expanded display (7.12)

3.5 Configuring the Functions (Setting Mode and Basic Setting Mode)

Bar graph	<ul style="list-style-type: none"> Channel display color (applies also to trends) (7.8) Bar graph direction (vertical/horizontal) (7.13) Number of scale divisions (applies also to trends) (7.10) Bar graph base position (7.10)
LCD	<ul style="list-style-type: none"> Background color (white or black) (7.13) Brightness (7.14) Backlight saver specifications (7.14)

Settings related to data storage

Item	Setting Mode	Basic Setting Mode
Data acquisition (8.11)		<ul style="list-style-type: none"> Types of data to be acquired Event data <ul style="list-style-type: none"> Sampling interval Mode (Free/Trigger/Rotate) Number of blocks (number of memory divisions) Data length (file size) Pretrigger position Type of trigger to use
Channel selections for data acquisition (8.10)		<ul style="list-style-type: none"> Measurement channels that data are to be acquired (applies also to measurement channels for which to display the trend) Computation channels (option) that data are to be acquired (applies also to computation channels for which to display the trend)
Storage media	<ul style="list-style-type: none"> Name of the directory to which data are to be saved (8.9) File header string (8.9) Range of data to be saved during manual save (8.9) Auto save interval (during auto save) (8.8) 	<ul style="list-style-type: none"> Save method to the storage media, auto save or manual save (8.11) Memory timeup(8.12)
Memory end alarm		<ul style="list-style-type: none"> Minimum remaining amount of internal memory at which to generate the alarm (10.8)
TLOG data		<ul style="list-style-type: none"> Timer mode (absolute time/relative time) (11.9) Interval time (11.9) Reference time for the absolute timer (11.9) Turn On/Off data storage to the internal memory (11.9)

Settings related only to the computation channels (configured on a screen dedicated to computation channels, option)

Item	Setting Mode	Basic Setting Mode
Computation specifications (11.4)	<ul style="list-style-type: none"> Computing equation Upper and lower limit of span Unit 	
Constants (11.6)	<ul style="list-style-type: none"> Constants (K01 to K12) 	
Alarm	<ul style="list-style-type: none"> Alarm type (11.5) Alarm value (11.5) Output relay On/Off (11.5) Output relay number (11.5) Alarm delay time (6.3) 	
Tag/Channel display	<ul style="list-style-type: none"> Tag name (7.1) 	

3.5 Configuring the Functions (Setting Mode and Basic Setting Mode)

Trend	<ul style="list-style-type: none"> Channel display color (7.8) Number of scale divisions (7.10) Scale position (7.10) Zone display (7.9) Partial expansion display (7.11) 	<ul style="list-style-type: none"> Computation channels to display the trend (applies also to computation channels that data are to be acquired) (8.10)
Bar graph	<ul style="list-style-type: none"> Channel display color (Applies also to trends) (7.8) Number of scale divisions (7.10) Bar graph base position (7.10) 	
TLOG computation	<ul style="list-style-type: none"> Timer number to use, sum scale (11.8) 	<ul style="list-style-type: none"> Timer mode (absolute time/relative time) (11.9) Interval time (11.9) Reference time for the absolute timer (11.9) Turn On/Off reset at each interval (11.9) Turn On/Off data storage to the internal memory (11.9)
Rolling average (11.10)	<ul style="list-style-type: none"> On/Off Sampling interval Number of samples 	

Other settings

Item	Setting Mode	Basic Setting Mode
Time	<ul style="list-style-type: none"> Date/time(3.7) 	
User key	<ul style="list-style-type: none"> Action assignment (10.2) 	
Key lock (10.4)		<ul style="list-style-type: none"> Use/Not use key lock Password Keys to lock, enable/disable the key lock
Key login (10.6)		<ul style="list-style-type: none"> Use/Not use key login Auto logout On/Off Use/Not use user ID User name User ID Password Allow/Prohibit basic setting mode
Remote control (option) (10.9)		<ul style="list-style-type: none"> Action assignment on remote terminals
Report (option) (11.13)		<ul style="list-style-type: none"> Report types Date/Time of creation Report channel assignments Sum scale
Display language (10.10)		<ul style="list-style-type: none"> Select the display language
Daylight savings time (10.14)		<ul style="list-style-type: none"> Date/Time to switch
Temperature (10.15)		<ul style="list-style-type: none"> Temperature unit
Time zone (10.16)		<ul style="list-style-type: none"> Time difference from GMT
Batch (option)	<ul style="list-style-type: none"> Application name (10.12) Supervisor name (10.12) Manager name (10.12) Batch number (10.12) Lot number (10.12) Auto increment of batch number (10.12) Switching batch name/time indication on memory summary (10.12) 	<ul style="list-style-type: none"> Use/Not use batch function (10.13)

3.5 Configuring the Functions (Setting Mode and Basic Setting Mode)

File management and data clearing

Operations related to the internal memory

Item	Setting Mode	Basic Setting Mode
Initialization of settings/data clearing	<ul style="list-style-type: none"> Clear measured/computed data in the internal memory (9.7) 	<ul style="list-style-type: none"> Initialize settings (basic setting mode/setting mode) and clear measured/computed data in the internal memory (9.8)

Management of files on the external storage media

Item	Setting Mode	Basic Setting Mode
File management	<ul style="list-style-type: none"> Save setup data (9.1) Load setup data (9.1) Save measured data with key operation (9.2) Load/display display data (9.3) Load/display event data (9.4) List files (9.5) Delete files (9.5) Format external storage media (9.5) 	<ul style="list-style-type: none"> Save setup data (9.1) Load setup data (9.1) Delete files (9.5) Format external storage media (9.5)

The menu screen and items of the setting mode

The menu screen and items of the setting mode are as follows. Enclosed in parentheses are reference sections. [Math set1], [Math set2], [Math set3] are displayed when the computational function (/M1) is equipped. [Batch set] is displayed when the batch function (/BT1) is equipped.

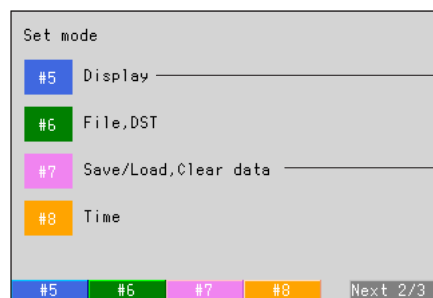

To [Display] menu on the next page

To [Save/Load, Clear data] menu on the next page

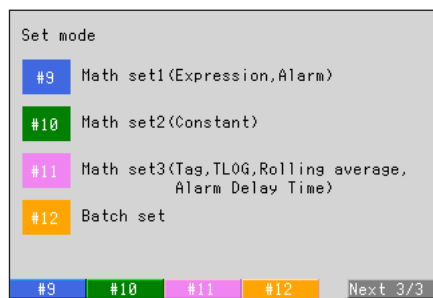

3.5 Configuring the Functions (Setting Mode and Basic Setting Mode)

[Display] menu

Display	
#1	Group set, Trip line
#2	Color
#3	Zone, Graph
#4	View, Direction, LCD
#5	Math (Color)
#6	Math (Zone, Graph)

#1 #2 #3 #4 Next 1/2

[Save/Load, Clear data] menu

Save/Load, Clear data	
#1	Save settings
#2	Load settings
#3	Save data
#4	Load display data
#5	Load event data
#6	File list
#7	Delete
#8	Format
#9	Clear data

#1 #2 #3 #4 Next 1/3

Soft key	Settings in the setting mode Title	Item
#1	Range (5.1 to 5.7)	Input type Measurement range Upper and lower limits of span Reference channel for difference computation Upper and lower limits of scale Unit
	Alarm (6.2)	Alarm type Alarm value Output relay On/Off Output relay number
#2	Tag (7.1)	Tag name
	Filter (5.8) Moving average (5.8)	Filter time constant/Off (DX102L/DX104L) Number of samples for the moving average/Off (DX106L/DX112L)
#3	Alarm delay time (6.3)	
	Trend/Save interval	Trend display rate (7.3) Auto save interval (8.8)
#4	USER key (10.2)	Assign an action to the USER key
#4	Message (7.5)	Message string
#5	Display	
#5 - #1	Group set/Trip line	Group name (7.6) Assign channels to groups (7.6) Trip line position, display color (7.7)
#5 - #2	Color (7.8)	Measurement channel display color
#5 - #3	Zone (7.9)	Zone upper and lower limits
	Graph (7.10)	Number of scale divisions for the trend and bar graph Bar graph base position Specify the scale display position for trends.
#5 - #3	Partial (7.11)	Turn On/Off partial expanded display Position and boundary for the partial expanded display
#5 - #4	View (7.13)	Trend display direction Bar graph display direction Background color (white or black) Trend line width Trip line width Grid for the trend display Group display switching interval (Scroll time) Scale digit

3.5 Configuring the Functions (Setting Mode and Basic Setting Mode)

Soft key	Settings in the setting mode Title	Item
#5 - #4	LCD (7.14)	LCD brightness Turn On/Off the LCD backlight saver Transition time for the LCD backlight saver and conditions that restore the backlight
#5 - #5	Math (Color) (7.8)	Computation channel display color
#5 - #6	Zone (7.9)	Zone upper and lower limits for the computation channels
	Graph (7.10)	Number of scale divisions for the trend and bar graph displays for the computation channels Bar graph base positions for the computation channels Specify the scale display position for trends for the computation channels.
	Partial (7.11)	Turn On/Off partial expanded display for the computation channels Position and boundary for the partial expanded display for the computation channels
#6	File (8.9)	Header string to be written to file Name of directory to which data are to be saved Range of data to be saved during manual save
	Daylight savings time (10.14)	Summer/winter time On/Off
#7	Save/Load, Clear data	
#7 - #1	Save settings	Save setup data to the external storage medium (9.1)
#7 - #2	Load settings	Load setup data from the external storage medium (9.1)
#7 - #3	Save data	Store measured data using key operation (9.2)
#7 - #4	Load display data	Load/Display the display data on the external storage medium (9.3)
#7 - #5	Load event data	Load/Display the event data on the external storage medium (9.4)
#7 - #6	File list	List the files on the external storage medium (9.5)
#7 - #7	Delete	Delete files on the external storage medium (9.5)
#7 - #8	Format	Format the external storage medium (9.5)
#7 - #9	Clear data	Clear the measure/computed data in the internal memory (9.7)
#8	Time set (3.7)	Date/time
#9	Math range (11.4)	Computing equations, display span, and unit for computation channels
	Math alarm (11.5)	Alarm type for the computation channels Alarm value for the computation channels Output relay On/Off for the computation channels Output relay number for the computation channels
#10	Constant (11.6)	Constants (K01 to K12)
#11	Tag (7.1)	Tag names of the computation channels
	TLOG (11.8)	Timer number used in TLOG, sum scale
	Rolling average (11.10)	Turn On/Off the rolling average Sampling interval and the number of samples for the rolling average
	Alarm delay time (6.3)	
#11	Batch set (10.12)	Application name Supervisor name Manager name Batch number Lot number Auto increment of batch number Switching batch name/time indication on memory summary

The menu screen and items of the basic setting mode

The menu screen and items of the basic setting mode are as follows. Enclosed in parentheses are reference sections.

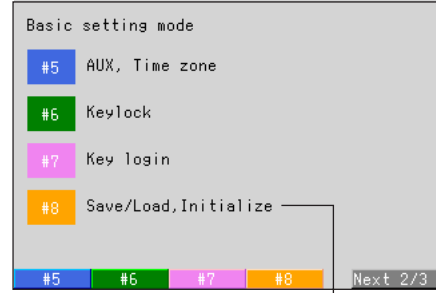
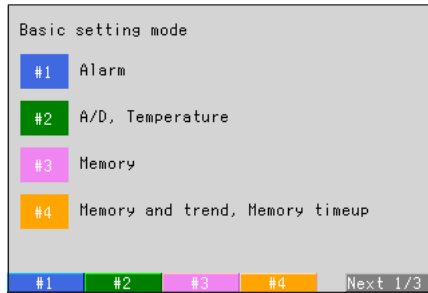

To [Save/Load, Initialize] menu below

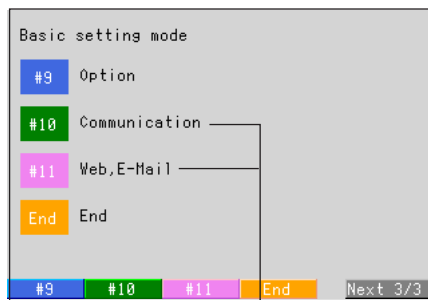

[Save/Load, Initialize] menu

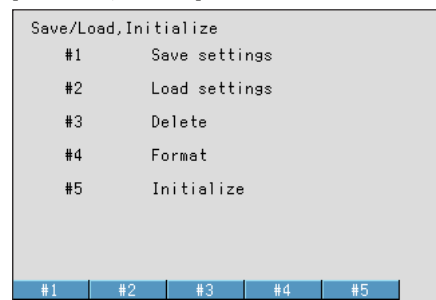

See the DX100/DX200 communication Interface User's Manual.

Soft key	Settings in the basic setting mode Title	Item
#1	Alarm (6.4)	Reflash alarm AND operation of alarm output relays Energize/de-energize alarm output relays Hold/non-hold alarm output relays Hold/non-hold alarm displays Rate-of-change alarm interval Turn On/Off the alarm hysteresis
#2	A/D (5.9) Temperature (10.15)	Integration time of the A/D converter Scan interval Burn out Off/Up/Down Reference junction compensation (select internal/external, compensation voltage when using external) Temperature unit
#3	Memory (8.11)	Save method to the external storage medium Type of data to be acquired Event data <ul style="list-style-type: none"> • Sampling interval • Mode (Free/Trigger/Rotate) • Number of blocks (number of memory divisions) • Data length (file size) • Pretrigger position • Type of trigger to use
#4	Memory & trend (8.10) Memory timeout (8.12)	Measurement channels to acquire data/display the trend Computation channels to acquire data/display the trend Date and time to save data

3.5 Configuring the Functions (Setting Mode and Basic Setting Mode)

Soft key	Settings in the basic setting mode	
	Title	Item
#5	Aux	Switch between tag display and channel display (7.2) Minimum remaining amount of internal memory at which to generate the alarm (10.8) Set the displayed language (10.10) Use/Not use partial expanded display (7.12) Use/Not use batch function (for models with /BT1) (10.13)
	Time zone(10.16)	Time difference from GMT
#6	Key lock (10.4)	Use/Not use key lock Password Keys to lock, enable/disable the key lock
#7	Key login (10.6)	Use/Not use key login Auto logout On/Off Use/Not use user ID User name User ID Password Allow/Prohibit basic setting mode
#8	Save/Load, Initialize	
#8 - #1	Save settings	Save setup data to the external storage medium (9.1)
#8 - #2	Load settings	Load setup data from the external storage medium (9.1)
#8 - #3	Delete	Delete files on the external storage medium (9.5)
#8 - #4	Format	Format the external storage medium (9.5)
#8 - #5	Initialize	Initialize the setup data in the internal memory and clear measured/computed data (9.8)
#9	Option	
#9 - #1	Remote (10.9)	Action assignment on remote terminals
#9 - #2	Report (11.13)	Report types Date/Time of creation Report channel assignments Sum scale
#9 - #3	Timer (TLOG) (11.9)	Timer mode (absolute time/relative time) Interval Reference time for the absolute timer Turn On/Off reset at each interval Turn On/Off data storage
#10	Communications	
#10 - #1	Ethernet (IP_Address)*	
#10 - #2	Ethernet (DNS)*	
#10 - #3	FTP transfer file*	
#10 - #4	FTP connection*	
#10 - #5	Control (login, timeout)*	
#10 - #6	Serial/Memory out*	
#11	Web, E-Mail	
#11 - #1	Web*	
#11 - #2	Basic E-Mail settings*	
#11 - #3	Alarm E-Mail settings*	
#11 - #4	Scheduled E-Mail settings*	
#11 - #5	System E-Mail settings*	
#11 - #6	Report E-Mail settings*	
End	End (3.6)	Terminate operations in the basic setting mode

* See the DX100/DX200 Communication Interface User's Manual (IM 04L02A01-17E).

3.6 Common Key Operations

This section describes common key operations that are used often.

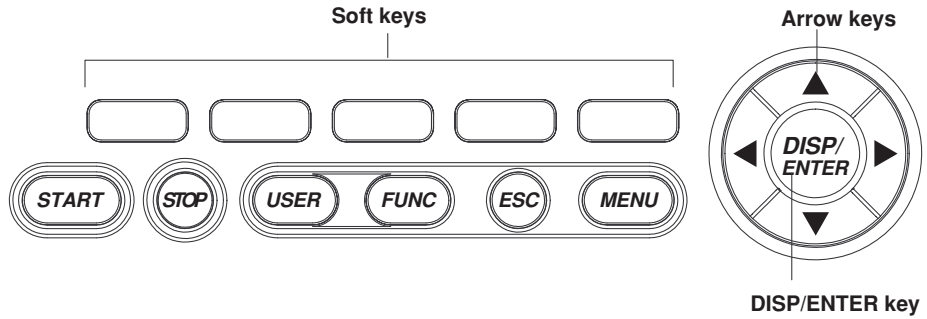

Key operations in the basic setting mode

Procedure

Entering the basic setting mode

1. Press the MENU key to enter the setting mode.
2. Hold the FUNC key down for three seconds to enter the basic setting mode.
3. Press the soft key to enter individual setting screens.

Note

- Basic setting mode cannot be entered while data acquisition or computation is in progress or the storage medium is being accessed. Stop data acquisition and computation first before entering the basic setting mode.
- Changing and storing the data acquiring method in the basic setting mode ([#3 Memory] and [#4 Memory and trend]) clears the measured/computed data in the internal memory. Make sure to save the data to the external storage medium before entering the basic setting mode.

Common key operations in the basic setting mode are described.

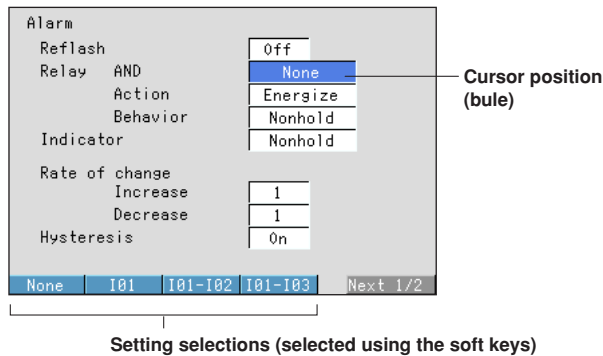

3.6 Common Key Operations

Selecting the parameter

1. Use the arrow keys to move the cursor (blue) to the appropriate parameter. The available selections are displayed at the bottom of the screen above the soft keys.
2. Select the parameter with the soft key. The box containing the parameter that was changed turns yellow. The cursor moves to the next parameter. To cancel the settings, press the ESC key. A window appears for you to confirm the cancellation. Select [Yes] and press the DISP/ENTER key.

Confirming the settings

1. Pressing the DISP/ENTER key confirms the new settings. The parameter boxes return to a white color. The cursor moves to the first parameter on the page.

Returning to the menu screen of the basic setting mode

1. Press the ESC key to return to the menu screen of the basic setting mode.

Exiting the basic setting mode

Carry out the following steps when the basic setting menu is displayed.

1. Press the [END] soft key. A confirmation window with a message [Do you want to store and make the new settings take effect?] appears.
2. Selecting [Yes] with the arrow key and pressing the DISP/ENTER key saves the new settings and returns to the operation mode.

If you do not wish to save the new settings, select [No] with the arrow key and press the DISP/ENTER key to return to the operation mode.

Selecting [Cancel] with the arrow key and pressing the DISP/ENTER key cancels the “operation to exit the basic setting mode” and returns to the basic setting mode menu. In this case, the setting changes made up to that point are held.

Key operations in the setting mode

Procedure

Entering the setting mode

1. Press the MENU key to enter the setting mode.
2. Press the soft key to enter individual setting screens.

The screenshot shows a menu with the following content:

First-CH: 01 Last-CH: 01

Range

Mode	Range	Span_L	Span_U
Volt	2V	-2.000	2.000

Alarm

	Type	Value	Rly	No.
1	On	H	1.000	On
2	On	L	-1.100	Off
3	Off			
4	Off			

At the bottom, there are soft key selections: Skip, Volt, TC, RTD, and Next 1/2. The 'Volt' key is highlighted in yellow. A blue cursor is positioned over the 'Volt' text in the Range Mode row.

Cursor position (blue)

Setting selections (selected using the soft keys)

Selecting the parameter

1. Use the arrow keys to move the cursor (blue) to the appropriate parameter. The available selections are displayed at the bottom of the screen above the soft keys.
2. Select the parameter with the soft key. The box containing the parameter that was changed turns yellow. The cursor moves to the next parameter. To cancel the settings, press the ESC key. A window appears for you to confirm the cancellation. Select [Yes] and press the DISP/ENTER key.

Confirming the settings

1. Pressing the DISP/ENTER key confirms the new settings. The parameter boxes return to a white color. The cursor moves to the first parameter on the page.

Returning to the menu screen of the setting mode

1. Press the Menu or ESC key to return to the menu screen of the setting mode.

Exiting the setting mode

1. Press the MENU or the ESC key to save the settings and return to the operation mode.

Entering Numbers

The operation to enter numbers is used such as when setting the date, time, or the display span of the input range.

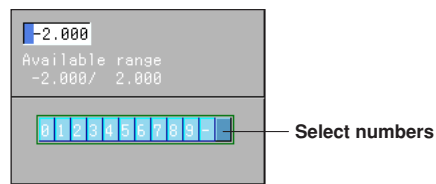
Window for entering numbers**Procedure**

When the window used to enter the numbers appears, enter the value according to the following key operations.

- **Left and right arrow keys:** Selects the input position
- **Up and down arrow keys:** Enters the number

Entering characters

Used to set tag names, set message strings, set or enter passwords.

Window for entering characters

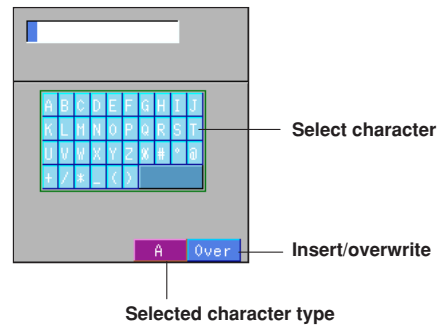

Procedure

When the window used to enter the string appears, enter the characters according to the following key operations.

- **Left and right arrow keys:** Selects the input position
- **Up and down arrow key:** Enters the character
- **[A/a/1] soft key:** Selects upper-case alphabet (A), lower-case alphabet (a), or numbers (1).

The character type is switched in the following order each time the [A/a/1] soft key is pressed. The selected character type is displayed to the right down of the input window.

Upper-case alphabet (A) → lower-case alphabet (a) → numbers (1)

- **[DEL] soft key:** Deletes the character at the cursor position.
- **[BS] soft key:** Deletes the character to the left of the cursor position.
- **[INS] soft key:** Selects insert or overwrite

Insert and overwrite modes switch each time the [INS] soft key is pressed. The selected mode is displayed to the right down of the window.

Copying/clearing character strings

When entering a character string in the basic setting mode or the setting mode, you can copy and paste a preexisting string. You can also clear a selected string. The soft keys used to perform these operations appear only when these operations are appropriate.

Procedure

Copying a character strings

To copy a character string to another box, follow the procedures below.

1. Move the cursor to the copy source string and press the [Copy] soft key. The [Paste] soft key appears.
2. Move the cursor to the copy destination box and press the [Paste] soft key. The character string is copied.



Clearing the character string

1. To clear the character string, press the [Clear] soft key.

3.7 Setting the Date and Time

Set the date and time. The set date and time can be specified whether it belong to the summer time or the winter time. The summer time and the winter time are defined by the daylight savings time adjustment function. For detail, see section 10.14, "Using the Daylight Savings Time Adjustment Function."

Procedure

Press .

Press the soft key .

To display the window for the date and time setting, press the soft key .

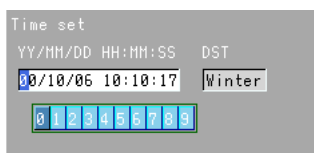

1. YY/MM/DD HH:MM:SS
Enter the date and time.
Pressing the [Input] soft key displays the number input keypad. Enter the date and time and press the [DISP/ENTER] key. For the procedures related to entering numbers, see "Entering Numbers" on page 3-21.
Pressing the DISP/ENTER key closes the window without setting the [DST] box. To cancel the setting and close the window, press the ESC key.
2. DST (Daylight savings time adjustment function)
[Summer] or [Winter] is displayed in the [DST] box corresponding to the date and time indicated in the [YY/MM/DD HH:MM:SS] box when the window is opened.
Operate as follows to set [Summer] or [Winter] for the date and time entered.
Pressing the right arrow key shifts the cursor to the [DST] box. Select [Summer] or [Winter] by the soft key and press the DISP/ENTER key. The window closes. To cancel the setting and close the window, press the ESC key before pressing the DISP/ENTER key.

4.1 Operation Screens

This chapter describes the screen (operation screen) used to display the measured/ computed data.

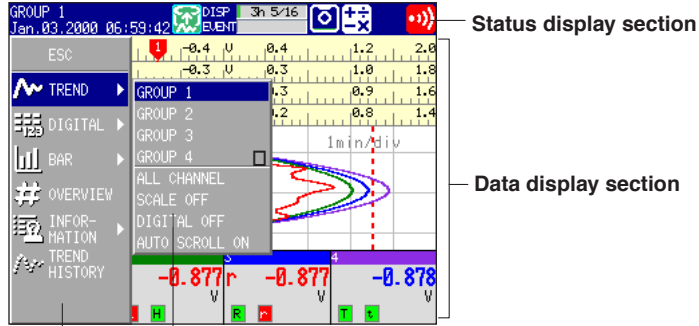

Sub menu
Screen menu
Displayed by pressing the DISP/ENTER key

- The screen consists of the status display section and the data display section.
- The operation screen includes trend, digital, bar graph, alarm summary, message summary, memory summary, report (option), and historical trend.
- The arrow keys and the DISP/ENTER key are used to switch the screen.
Screen menu: Displayed when the DISP/ENTER key is pressed.
Sub menu: Displayed when the right arrow key is pressed while the screen menu is displayed.
- The following operations are possible.
 - For trend, digital, and bar graph screens, the displayed group can be automatically switched.
 - Recalling the historical trend at the time the alarm selected in the Alarm Summary occurred or the message selected in the Message Summary is written. Also displaying the historical trend selected in the Memory Summary.
 - Switching to the trend or bar graph screen that contains the channel data pointed on the overview screen.

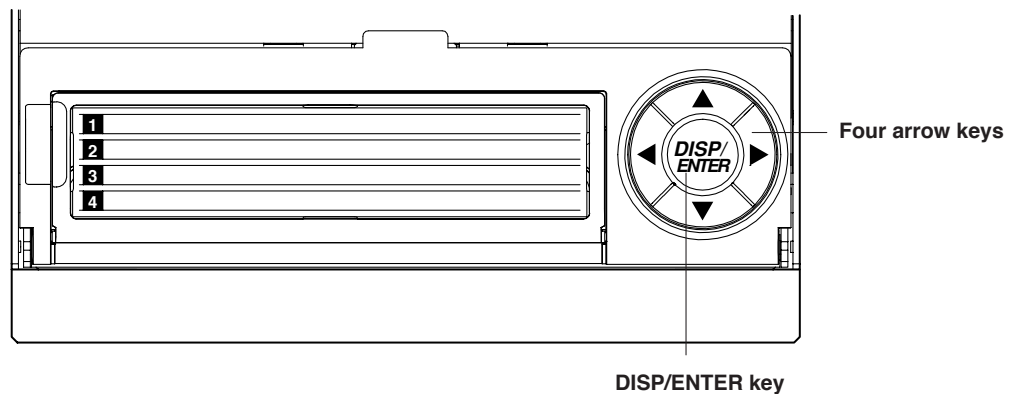

4.2 Explanation of the Status Display Section

The following information is displayed in the status display section during the operation mode and the setting mode. (The information is not displayed in the basic setting mode. [Setup Mode] is displayed instead).

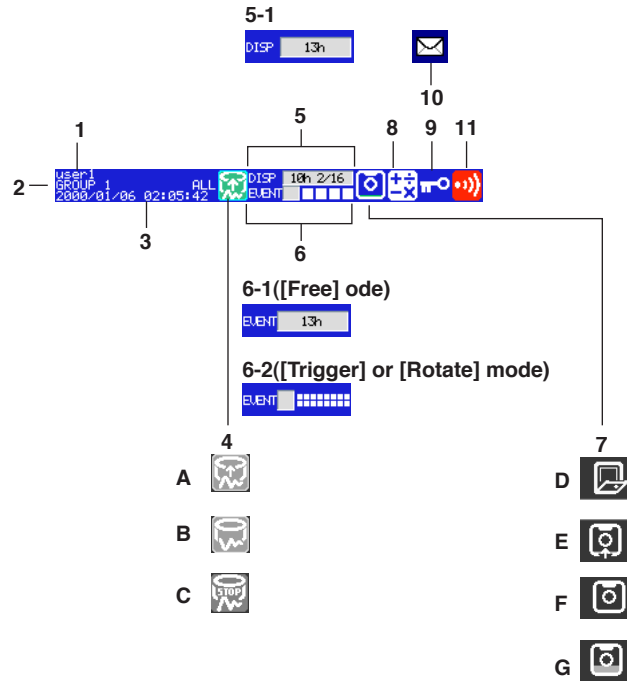

1. User name

The user name is displayed when a user is logged in using the key login function.

2. Group name or screen name

The name of the group or screen that is displayed in the data display section. [All] is displayed only during all channel display (see section 4.3).

3. Current date and time

The current date and time are displayed.

On models with the optional /BT1 batch function, the “date and time” and “batch number and lot number” are alternately displayed every 5 s when “Use batch function” (see section 10.13) is being set.

4. ON/OFF state of the measured/computed data acquisition.

A and B are displayed alternately: Data acquisition in progress or waiting for the event data trigger.

C: Data acquisition is suspended.

Note

For event data that starts acquiring data upon receiving a trigger, the indicator indicates that the data acquisition is in progress even when it is in the trigger wait state. The trigger wait state can be identified using the bar graph described in item 6.

5. The usage condition of the display data storage area in the internal memory

This is displayed when display data acquisition is enabled.

- Bar graph

Displays the used space of the display data storage area.

- Time period

The remaining time for acquiring the display data. When the remaining time is less than one hour, the time is displayed in units of minutes.

Remaining time	Unit	Note
Greater than or equal to 100 days	%	Percentage of the remaining area with respect to the display data storage area
Greater than or equal to 100 hours, less than 100 days	days	unit less than one day is rounded off.
Greater than or equal to 60 minutes, less than 100 hours	hours	unit less than one hour is rounded off.
Less than 60 minutes	minutes	unit less than one minute is rounded off.

- n/16

The maximum number of display data files that can be written to the internal memory is 16 (see section 8.2). "16" represents this value. "n" represents the number of files in the internal memory.

Note

The display data are overwritten for the following cases. Be aware of these cases, because data that are overwritten are lost.

- When the display data storage area in the internal memory becomes full.
In such case, [Overwrite] is displayed in the status display section.
- When the number of files that remains to be saved to the external medium exceeds 16.

6. The usage condition of the event data storage area in the internal memory

This is displayed when event data acquisition is enabled.

- **When the trigger mode is set to [Free] (see section 8.2)**

- Bar graph

Displays the used space of the event data storage area.

- Time period

The remaining time for acquiring the event data. When the remaining time is less than one hour, the time is displayed in units of minutes. For the detail of the displayed unit, see "Time period" in item 5 above.

- n/16

The maximum number of event data files that can be written to the internal memory is 16 (see section 8.2). "16" represents this value. "n" represents the number of files in the internal memory.

Note

The event data are overwritten for the following cases. Be aware of these cases, because data that are overwritten are lost.

- When the event data storage area in the internal memory becomes full.
In such case, [Overwrite] is displayed in the status display section.
- When the number of files that remains to be saved to the external medium exceeds 16.

4.2 Explanation of the Status Display Section

- **When the trigger mode is set to [Trigger] or [Rotate] (see section 8.2)**

- Bar graph

Displays the used space with respect to the specified memory length (data length, see section 8.11).

When pretrigger is specified and the START key is pressed causing the DX100L to enter the trigger wait state, data of size equal to the pretrigger amount are acquired to the internal memory. The bar is displayed in orange. After acquiring data of size equal to the pretrigger, the length of the bar stays fixed. However, the relevant data are updated until the trigger is activated. When the trigger is activated, the bar turns green. Data are acquired to the internal memory after the pretrigger data.

During the [Trigger] mode, [Full] is displayed when data acquisition to all blocks is complete. When [Full] is displayed, event data are no longer acquired even if the trigger condition is met. In this case, save the data in the internal memory to the external storage medium.

- Block display

When the event data storage area is divided into multiple blocks, the usage condition of the blocks are displayed.

White block: No data

Green block: Block containing data that were acquired to the internal memory after starting the current acquisition of event data.

Gray block: Block containing data that were acquired before the current start operation.

7. The external storage medium condition

D: The front cover is open.

No display: No storage medium inserted.

E and F displayed in order: Accessing the storage medium.

F: Storage medium is idle (no access)

G: The used space of the storage medium is indicated by the green level indicator in the icon. The colored section indicating the level turns red when the amount of free space on the storage medium falls below 10%.

Note

- When the front cover is closed, the DX100L checks whether or not an external storage medium is inserted in the drive.
 - Keep the front cover closed during operation in order to prevent adverse effects caused by foreign particles such as dust entering the DX100L.
-

8. Computation icon (Option)

Computation icon not displayed: No computation option or computation is suspended

White computation icon: Computation in progress

Yellow computation icon: Computation data dropout occurred

Note

Computation data dropout occurs when the computation is not completed within the scan interval. The computation icon returns to the green icon by pressing FUNC → [MathACK] soft key (see section 11.3). If a computation dropout occurs, make the scan interval longer (see section 5.9) or reduce the number of computation channels that are turned On (see section 11.4).

9. Key lock icon

Key icon: Key lock ON

No display: Key lock OFF

10. E-mail transmission function icon

Displayed when the e-mail transmission function is started.

11. Alarm icon

Displayed when any one of the alarms is occurring. For details, see section 6.1.

4.3 Using the Trend, Digital, and Bar Graph Screens

Operation Flow Diagram

TREND, DIGITAL, BAR GRAPH

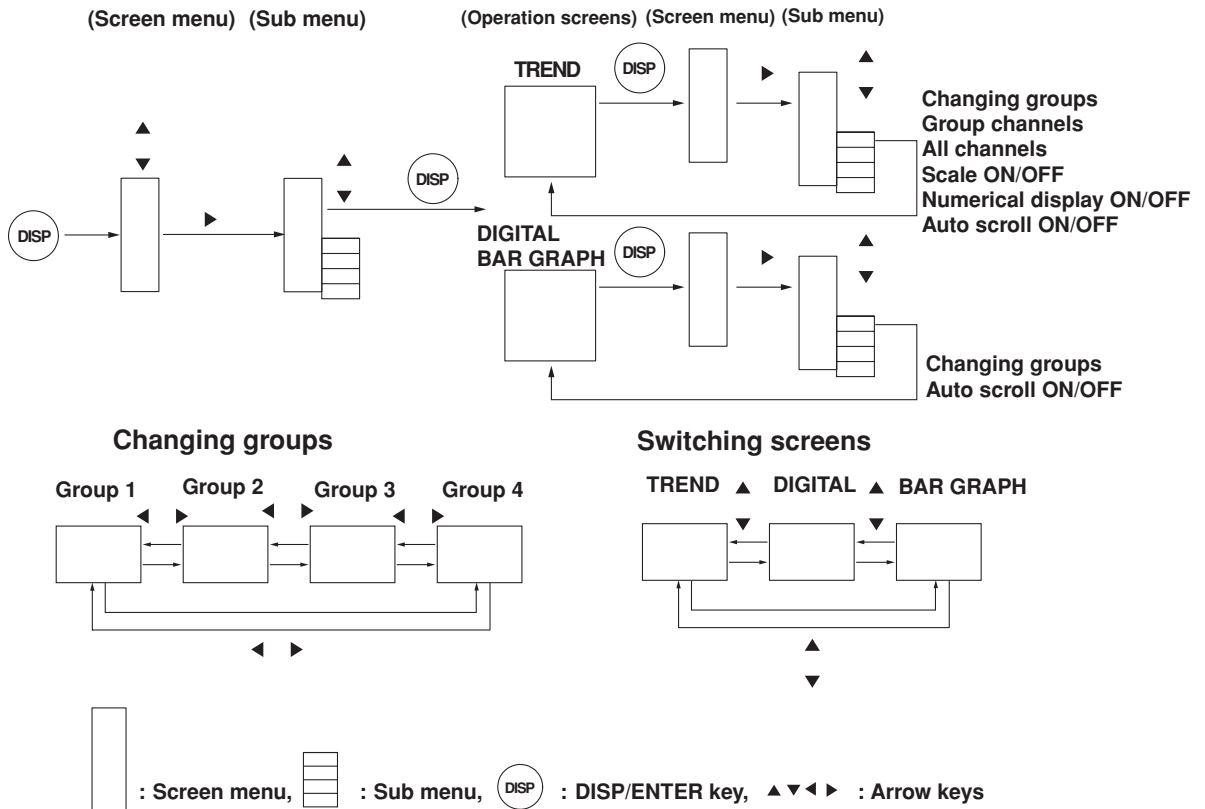

Procedure

Displaying the screen

1. Pressing the DISP/ENTER key displays the screen menu.
2. Select [Trend], [Digital], or [Bar Graph] using the up and down arrow keys.
3. Pressing the right arrow key displays the sub menu.
To close the sub menu, press the left arrow key.

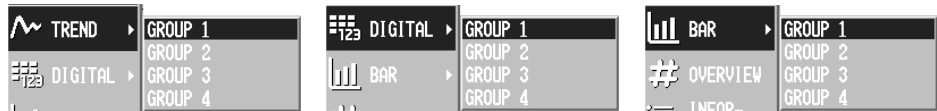

4. Select the group using the up and down arrow keys.
5. Pressing the DISP/ENTER key displays the screen.
To close the menu without switching the screen, press the ESC key.

4.3 Using the Trend, Digital, and Bar Graph Screens

Displaying or clearing the scale on the trend screen

This operation is carried out on the Trend screen.

1. Pressing the DISP/ENTER key displays the screen menu. ([Trend] is selected.)
2. Pressing the right arrow key displays the sub menu.
To close the sub menu, press the left arrow key.
3. Select [SCALE ON]* or [SCALE OFF].*

* The one that is selectable is displayed in the sub menu.



4. Pressing the DISP/ENTER key displays the scale.
To close the menu without displaying/clearing the scale, press the ESC key.

Showing the all channel display/returning to the group display

On the group display, the channels that are assigned to the group are displayed (see section 7.6). On the all channel display, the waveform of all channels that are set to display the trend (see section 8.10) are displayed over the current group display. See "Explanation."

1. Pressing the DISP/ENTER key displays the screen menu. ([Trend] is selected.)
2. Pressing the right arrow key displays the sub menu.
To close the sub menu, press the left arrow key.
3. Select [ALL CHANNEL]* or [GROUP CHANNEL] using the up and down arrow keys.

* The one that is selectable is displayed in the sub menu.



4. Pressing the DISP/ENTER key displays the screen.
To close the menu without switching the screen, press the ESC key.

Displaying or clearing the numerical display section on the trend screen

This operation is carried out on the Trend screen.

1. Pressing the DISP/ENTER key displays the screen menu. ([Trend] is selected.)
2. Pressing the right arrow key displays the sub menu.
To close the sub menu, press the left arrow key.
3. Select [DIGITAL ON]^{*} or [DIGITAL OFF]^{*} using the up and down keys.

* The one that is selectable is displayed in the sub menu.



4. Pressing the DISP/ENTER key displays/clears the numerical display section.
To close the menu without displaying/clearing the numerical section, press the ESC key.

Changing the group on the display screen

The following three methods are available. If all channel display is selected, waveforms for all channels that are registered to display the trend (see section 8.10) are displayed even when the group is changed.

- **Changing the group on the display screen from the screen menu**
 1. Pressing the DISP/ENTER key displays the screen menu.
 2. Pressing the right arrow key displays the sub menu.
To close the sub menu, press the left arrow key.
 3. Select the group using the up and down arrow keys.
 4. Pressing the DISP/ENTER key displays the selected group.
To close the menu without switching the screen, press the ESC key.
- **Changing the group on the display screen using the arrow keys**
 1. The displayed group changes in the order Group 1, Group 2, Group 3, Group 4, Group 1, and so on by pressing the right arrow key on the trend, digital, and bar graph screens.
 2. By pressing the left arrow key, the displayed group changes in the reverse order.
- **Automatically switch the displayed groups/stop the automatic switching**

The displayed group on the trend, digital, and bar graph screens can be automatically switched at the specified interval. In each screen, the displayed group rotates from group 1 to group 4. You can select 5 s, 10 s, 20 s, 30 s, or 1 min for the switch interval. For the procedure related to setting the switch interval, see section 7.13.

 1. On the trend, digital, and bar graph screens, press the DISP/ENTER key to display the screen menu.
 2. Press the right arrow key to display the sub menu. To close the sub menu that you opened, press the left arrow.

4.3 Using the Trend, Digital, and Bar Graph Screens

- To enable automatic switching, select [AUTO SCROLL ON]* using the up and down arrow keys. To disable automatic switching, select [AUTO SCROLL OFF]* using the up and down arrow keys.

* The one that is selectable is displayed in the sub menu.

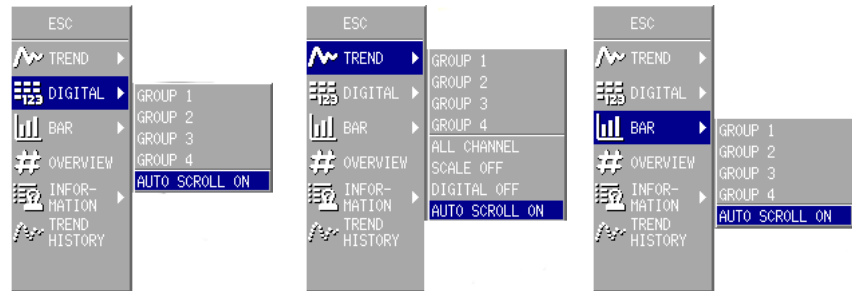

- Press the DISP/ENTER key to enable or disable the automatic switching of the displayed groups.

Switching the trend, digital, and bar graph screens

The following two methods are available:

- Switch between trend, digital, and bar graph from the screen menu**
The operating procedure is the same as “Displaying the screen” on page 4-5.
- Switching the trend, digital, and bar graph screens using the arrow keys**
 - The displayed screen changes in the order trend, digital, bar graph, trend, and so on by pressing the down arrow key on the trend, digital, and bar graph screens.
 - By pressing the up arrow key, the displayed screen changes in the reverse order.

Starting the waveform display of the trend screen/stopping the waveform update

The operation procedure used to start the waveform display of the trend screen and the procedure used to stop the waveform update are the same as the operation used to start/stop the data acquisition to the internal memory. When the data are being acquired to the internal memory, the waveform is displayed. When it is stopped, the waveform is not updated. For the operating procedure, see sections 8.4 and 8.6.

Explanation**About group display and all channel display**

The group display of trend, digital, and bar graph and the all channel display of the trend are displayed in the following fashion (see table below). They depend on whether channels are assigned to the groups and whether the channels are set to display the trend and store the data.

Assigned to Groups* ¹	Trend Display/Data Storage Specification* ²	Numerical Display* ³ Bar Graph	Trend's Waveform Display		Data Acquisition to the Internal Memory
			Group	All Channels	
Yes	Yes	Display	Display	Display	Yes
Yes	No	Display	Don't display	Don't display	No
No	Yes	Don't display	Don't display	Display	Yes
No	No	Don't display	Don't display	Don't display	No

*1 Whether or not the channel is assigned to a group.

*2 Whether or not the channel is set to display the trend and store the data.

*3 Numerical display refers to the numerical display of trend, digital, and bar graph screens.

- The numerical display of trend, digital, and bar graph screens and the bar graph display are updated at all times when they are displayed. It is not affected by whether or not the waveform of the trend screen is shown.
- The waveform of the trend screen is updated at the display update rate. For the procedure related to setting the display update rate, see section 7.3, "Setting the Display Update Rate (Trend)."
- For the procedure related to setting the channel to display the trend and to store the data, see section 8.10.
- For the procedure used to assign channels to groups, see section 7.6.

Alarm indication

Alarms are checked at all times and displayed on the relevant displays regardless of whether or not the waveform of the trend screen is shown.

Alarms are displayed using alarm type symbols. For details related to the alarms, see section 6.2.

Name	Symbol
Upper limit alarm	H
Lower limit alarm	L
Difference upper limit alarm	h
Difference lower limit alarm	l
Upper limit on rate-of-change alarm	R
Lower limit on rate-of-change alarm	r
Delay upper limit alarm	T
Delay lower limit alarm	t

The display direction of the trend and the bar graph

For the setting procedure of the display direction of the trend and the bar graph, see section 7.13.

4.3 Using the Trend, Digital, and Bar Graph Screens

Trend (Vertical Display)

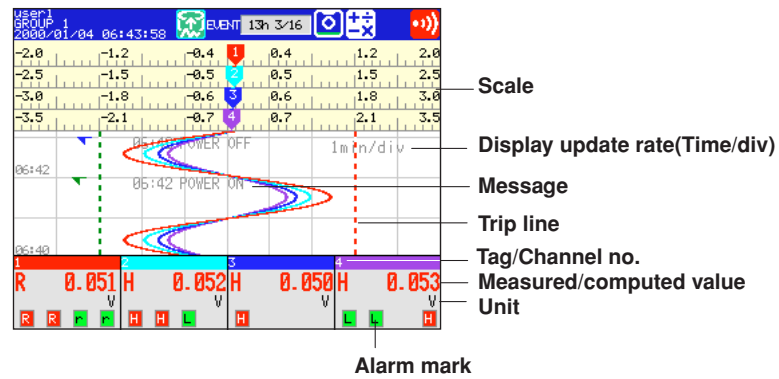

Trend (Vertical Display, All Channel Display)

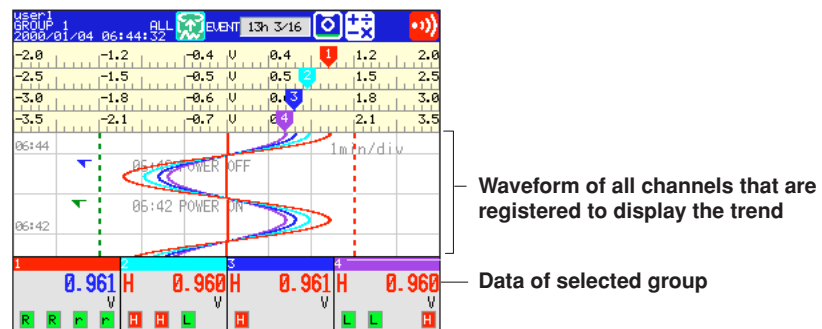

Digital

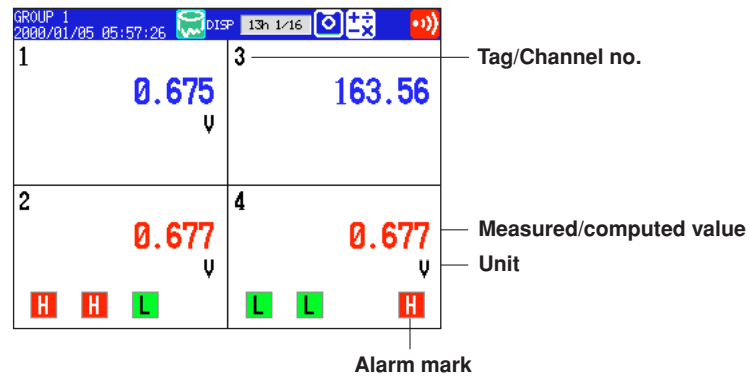

Bar Graph (Vertical Display)

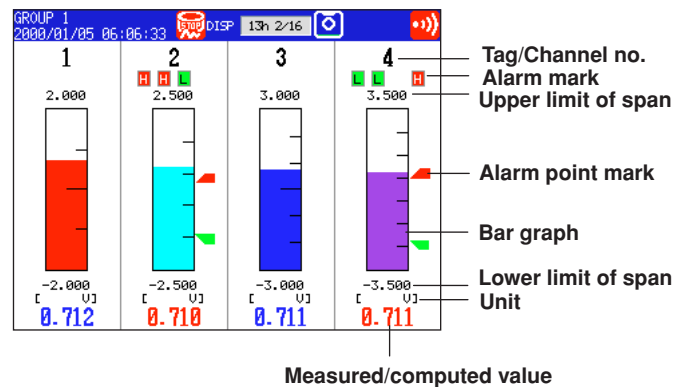

4.4 Using the Overview Screen

Operation Flow Diagram

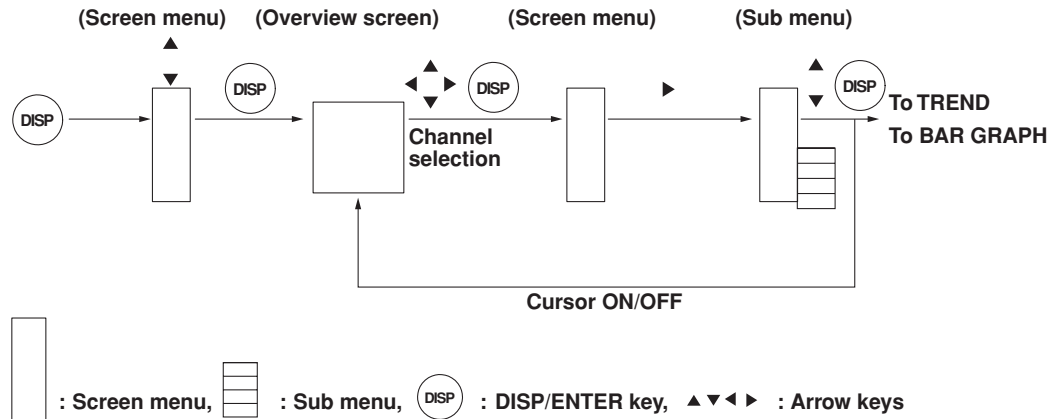

Procedure

Displaying the screen.

1. Pressing the DISP/ENTER key displays the screen menu.
2. Select [Trend], [Digital], or [Bar Graph] using the up and down arrow keys. Select [Overview] using the up and down arrow keys.
3. Pressing the DISP/ENTER key displays the screen. To close the menu without switching the screen, press the ESC key.

Displaying or clearing the cursor

1. Pressing the DISP/ENTER key displays the screen menu.
2. Pressing the right arrow key displays the sub menu. To close the sub menu, press the left arrow key.
3. Select [CURSOR ON]* or [CURSOR OFF].*



4. Pressing the DISP/ENTER key displays or clears the cursor. To close the menu without displaying/clearing the cursor, press the ESC key.

Switching to the trend or bar graph screen of the channel selected with the cursor

1. Move the cursor to select the channel using the arrow key.
2. Pressing the DISP/ENTER key displays the screen menu.
3. Pressing the right arrow key displays the sub menu. To close the sub menu, press the left arrow key.
4. Select [JUMP TO TREND] or [JUMP TO BAR] using up and down arrow keys.



5. Pressing the DISP/ENTER key displays the screen. To close the menu without displaying the screen, press the ESC key.

4.4 Using the Overview Screen

Explanation

Overview Screen

Tag/Channel no.	1	7	31	37
Cursor	133.1	L -163.8		
	2	8	32	38
	100.1	-214.6		
Alarm type	3	9	33	39
	84.0	L -142.3		
Measured/ computed value	4	10	34	40
	59.9	132.3		
	5	11	35	41
	39.3	179.0		
	6	12	36	42
	17.5	125.9		

The area corresponding to a channel on which an alarm is occurring is displayed in red.

The area corresponding to a channel on which an alarm is not occurring is displayed in green.

4.5 Using the Information Screen (Alarm Summary, Message Summary, and Memory Summary)

Operation Flow Diagram

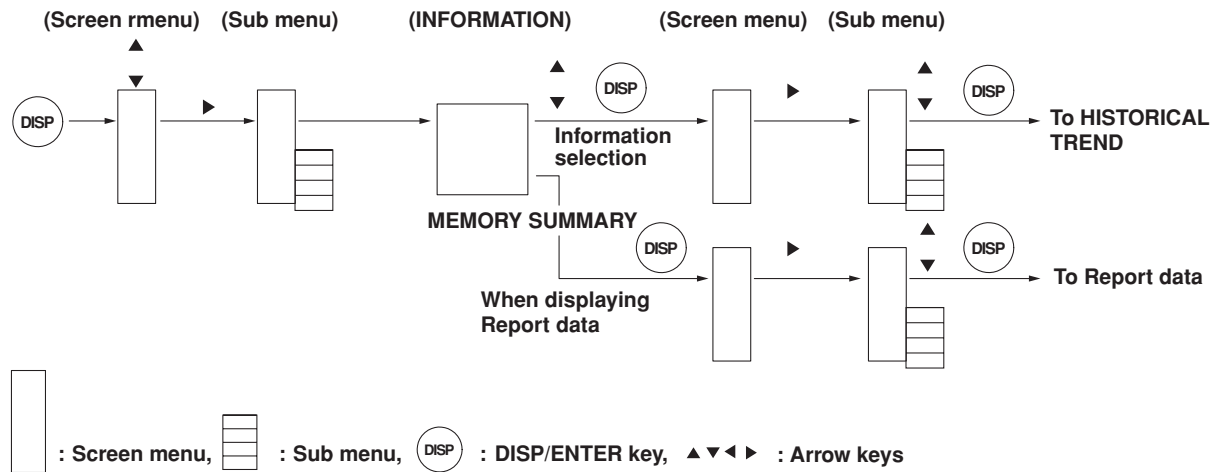

Procedure

Displaying the alarm summary, message summary, or memory summary

- Pressing the DISP/ENTER key displays the screen menu.
- Select [INFORMATION] using the up and down arrow keys.
- Pressing the right arrow key displays the sub menu.
To close the sub menu, press the left arrow key.
- Select [ALARM SUMMARY], [MESSAGE SUMMARY], or [MEMORY SUMMARY] using the up and down arrow keys.



- Pressing the DISP/ENTER key displays the screen.
To close the menu without displaying the screen, press the ESC key.

Recalling the historical trend at the time the alarm occurred

This operation is carried out on the Alarm Summary screen.

- Select the alarm of which to display the trend using the up and down arrow keys.

Selected alarm →

(006/006) Channel	Type	Alarm IN Time	Alarm OUT Time
1	1H	Jan.09 01:13:13	Jan.09 01:13:33
1	2L	Jan.09 01:12:14	Jan.09 01:12:25
3	1H	Jan.09 01:11:07	Jan.09 01:11:09
1	1H	Jan.09 01:10:58	Jan.09 01:11:05
1	1H	Jan.09 01:10:54	Jan.09 01:11:24
1	2L	Jan.09 01:10:03	Jan.09 01:10:18

- Pressing the DISP/ENTER key displays the screen menu.
- Pressing the right arrow key displays the sub menu.
To close the sub menu, press the left arrow key.
- Select [JUMP TO HISTORY] using the up and down arrow keys.



4.5 Using the Information Screen (Alarm Summary, Message Summary, and Memory Summary)

- Pressing the DISP/ENTER key displays the historical trend.
The displayed data type is as follows:
 - When configured to acquire only the display data to the internal memory:
Display data
 - When configured to acquire only the event data to the internal memory:
Event data
 - When configured to acquire the display data and the event data to the internal memory:
Data type selected in the memory summaryTo close the menu without switching the screen, press the ESC key.

Recalling the historical trend at the time the message was written

This operation is carried out on the Message Summary screen.

- Select the message of which to display the trend using the up and down arrow keys.

Selected message

(004/004) Message	Time
→ POWER OFF	Jan. 09. 2000 01:07:34
STOP	Jan. 09. 2000 01:07:09
INPUT	Jan. 09. 2000 01:05:41
POWER ON	Jan. 09. 2000 01:05:10

- Pressing the DISP/ENTER key displays the screen menu.
- Pressing the right arrow key displays the sub menu.
To close the sub menu, press the left arrow key.
- Select [JUMP TO HISTORY] using the up and down arrow keys.



- Pressing the DISP/ENTER key displays the historical trend.
The displayed data type is as follows:
 - When configured to acquire only the display data to the internal memory:
Display data
 - When configured to acquire only the event data to the internal memory:
Event data
 - When configured to acquire the display data and the event data to the internal memory:
Data type selected in the memory summaryTo close the menu without switching the screen, press the ESC key.

Selecting the type of file (display data or event data) to display in the Memory Summary

This operation is carried out on the Memory Summary screen.

- Select display data or event data using the left and right arrow keys.
The selected file type is indicated by a green circle to the left of [DISPLAY DATA] or [EVENT DATA]. Information about the selected file is displayed.

4.5 Using the Information Screen (Alarm Summary, Message Summary, and Memory Summary)

Opening the display/event data file from Memory Summary (recalling the historical trend).

1. Select the file using the up and down arrow keys.

Selected file

Start Time	End Time	Data	Factor
Jan.09 01:10:38	Jan.09 01:14:02	103	Sample
Jan.09 01:05:04	Jan.09 01:08:28	99	Stop
Jan.09 00:27:56	Jan.09 00:58:40	923	Stop
Jan.08 23:26:08	Jan.09 00:25:02	1768	Stop
Jan.08 23:23:38	Jan.08 23:23:50	7	Stop

2. Pressing the DISP/ENTER key displays the screen menu.
3. Pressing the right arrow key displays the sub menu.
To close the sub menu, press the left arrow key.



4. Select [JUMP TO HISTORY] using the up and down arrow keys.
5. Pressing the DISP/ENTER key displays the historical trend.
To close the menu without switching the screen, press the ESC key.

Displaying the report data (option)

This operation is carried out on the Message Summary screen. For detail of the report data, see section 11.11.

1. Pressing the DISP/ENTER key displays the screen menu.
2. Pressing the right arrow key displays the sub menu.
To close the sub menu, press the left arrow key.
3. Select [REPORT DATA] using the up and down arrow keys.



4. Pressing the DISP/ENTER key displays the report data.
To close the menu without displaying the report data, press the ESC key.

Changing the report data to be displayed

“The index number of the report data currently displayed/the number of report data sets in the internal memory” is displayed in the [Index] column of the report data display. The most recent report data set is the one with the largest report data index number.

When the report data are being displayed, the arrow keys can be pressed to switch the report being displayed. The operation when the four arrow keys are pressed are as follows:

Up arrow key: Displays next report data.

Down arrow key: Displays the previous report data.

Right arrow key: Displays the report data that is 10 data sets after the report data being displayed. However, if there are less than 10 data sets, the most recent report data (with the maximum report data index number) are displayed.

Left arrow key: Displays the report data that is 10 data sets before the report data being displayed. However, if there are less than 10 data sets, the oldest report data (report data index number 1) are displayed.

4.5 Using the Information Screen (Alarm Summary, Message Summary, and Memory Summary)

Explanation

Alarm Summary

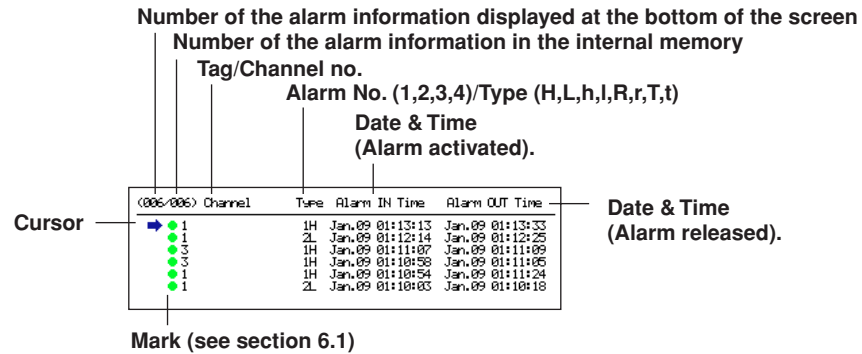

Message Summary

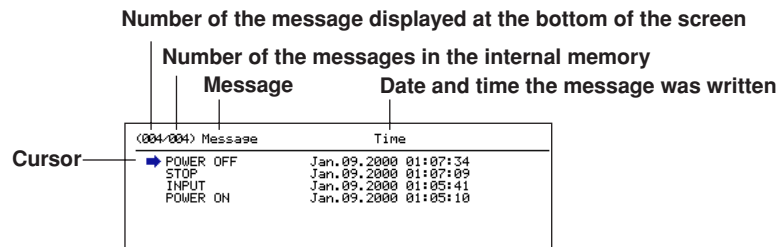

The date and time when the message was entered and the user name (when using key login function) are displayed.

Memory Summary

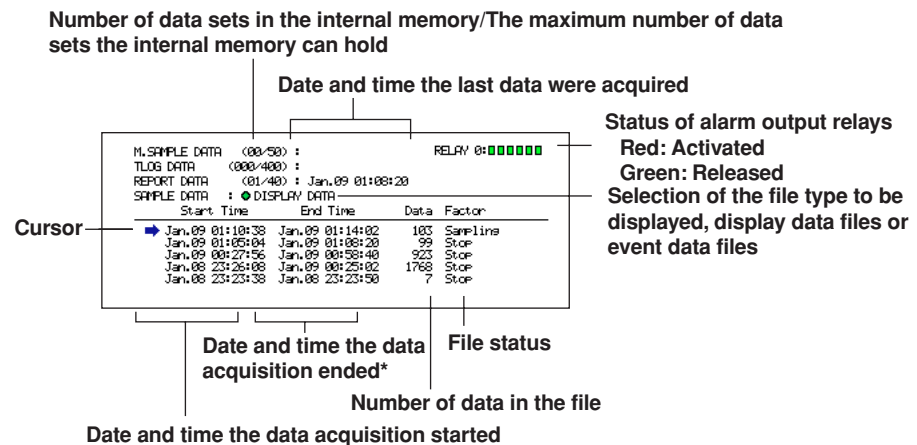

* On models with the optional /BT1 batch function, the batch number and lot number for each file can be displayed in place of the date and time the data acquisition ended.

4.5 Using the Information Screen (Alarm Summary, Message Summary, and Memory Summary)

Report Data (/M1 option)

The index number of the report data currently displayed

The number of report data sets in the internal memory

Report type

Index:	2/2	Kind:	Hourly			
Start:	Jan.09.2000 01:10:36					
Timeup:	Jan.09.2000 01:15:31					
Ch	Unit	Sts	Ave	Max	Min	Sum
01	U	---	0.093	1.522	-1.131	2.735488E+01
02	U	---	0.093	1.525	-1.131	2.741788E+01
03	U	---	0.093	1.522	-1.131	2.736100E+01
04		---	-32.91	-20.70	-60.44	-1.563545E+04

Date and time the report started

Date and time the report was created

Status of data (see section 11.11)

Note

When new report data are created while displaying the report data, the screen is not updated.

The most recent report data can be displayed by carrying out the following operations.

- Press the DISP/ENTER key and display the report data again from the menu, or
- Press the right arrow key.

4.6 Using the Historical Trend

Operation Flow Diagram

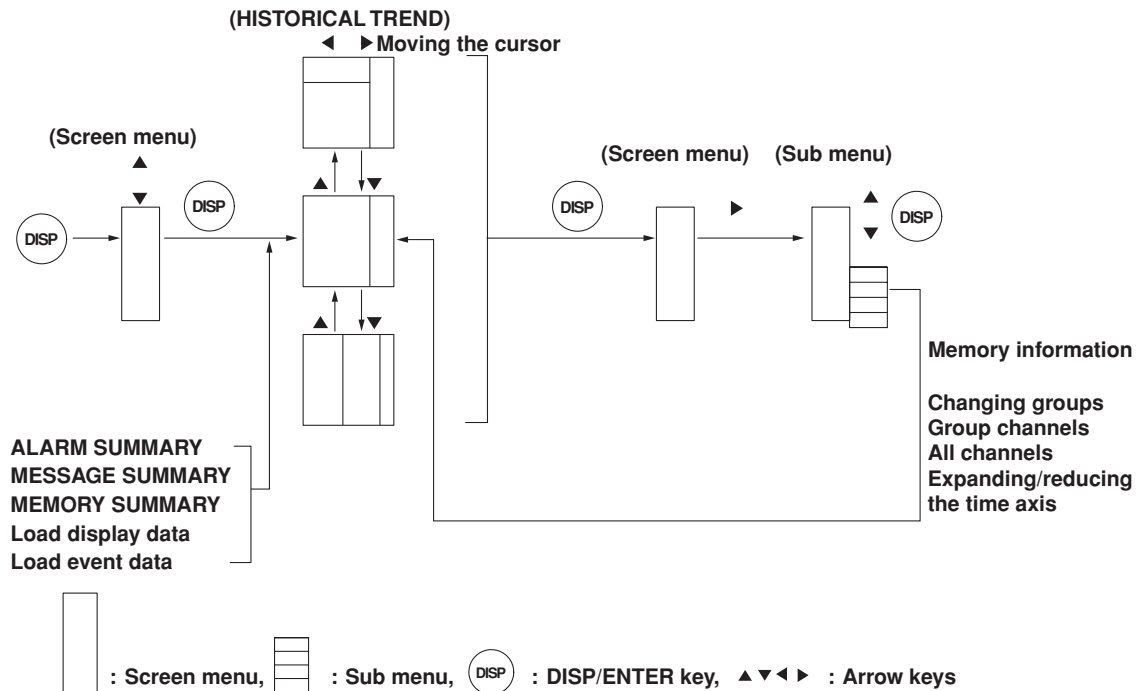

Procedure

There are 6 methods in displaying the historical trend screen.

- From the alarm summary. See section 4.5.
- From the message summary. See section 4.5.
- From the memory summary. See section 4.5.
- From [Load display data]. See section 9.3.
- From [Load event data]. See section 9.4.
- Recall from the screen menu. Described in this section.

Displaying the historical trend screen (from the screen menu)

Of the data being sampled, the display data existing before the execution of this operation are displayed as a historical trend.

1. Pressing the DISP/ENTER displays the screen menu.
2. Select [TREND HISTORY] using the up and down arrow keys.
3. Pressing the DISP/ENTER key displays the screen.

To close the menu without switching the screen, press the ESC key.

Note

Even if the display data are not configured to be acquired to the internal memory (see section 8.11), the display data existing before the execution of this operation are displayed as a historical trend.

Showing the all channel display/returning to the group display

On the group display, the channels that are assigned to the group are displayed (see section 7.6.) On the all channel display, the waveform of all channels that are set to display the trend (see section 8.10) are displayed over the current group display. See the explanation in section 4.3.

This operation is carried out on the Historical Trend screen.

1. Pressing the DISP/ENTER key displays the screen menu. ([TREND HISTORY] is selected.)

2. Pressing the right arrow key displays the sub menu.
To close the sub menu, press the left arrow key.
3. Select [ALL CHANNEL] or [GROUP CHANNEL] using the up and down arrow keys.



4. Pressing the DISP/ENTER key displays the screen.
To close the menu without switching the screen, press the ESC key.

Changing the group on the display screen

If all channel display is selected, waveforms for all channels that are registered to display the trend (see section 8.10) are displayed even when the group is changed.

1. Pressing the DISP/ENTER key displays the screen menu. ([TREND HISTORY] is selected.)
2. Pressing the right arrow key displays the sub menu.
To close the sub menu, press the left arrow key.
3. Select the group using the up and down arrow keys.
4. Pressing the DISP/ENTER key displays the selected group.
To close the menu without switching the screen, press the ESC key.

Expanding/ reducing the time axis

The time axis can be expanded or reduced with respect to the display reference position.

Display data: The time axis can be expanded to twice the trend display. It can also be reduced down to minimum 1/60th of the trend display.

Event data: The time axis can be reduced down to minimum 1/60th.

The factor by which the display can be expanded or reduced at one time by carrying out the procedures below varies depending on the display update rate for the display data, and the sampling interval for the event data being displayed. To expand or reduce the display further, repeat the procedures below

1. Pressing the DISP/ENTER key displays the screen menu. ([TREND HISTORY] is selected.)
2. Pressing the right arrow key displays the sub menu.
To close the sub menu, press the left arrow key.
3. Select [ZOOM +] or [ZOOM -] using the up and down arrow keys.



4. Pressing the DISP/ENTER key expands or reduces the time axis.
To close the menu without switching the screen, press the ESC key.

Scrolling the waveform

Pressing the up or down arrow key (vertical display) or the left or right arrow key (horizontal display) while displaying the historical trend scrolls the waveform along the time axis.

4.6 Using the Historical Trend

Specifying the displayed position with the cursor

The cursor position on the all data display locates the display reference position. Enclosed in parentheses are for the horizontal trend display.

1. Pressing the right (up) arrow key displays the all data display in the right (upper) section of the screen.

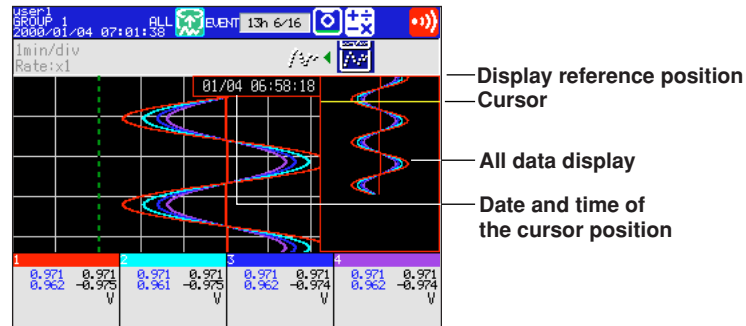

2. Move the cursor to select the displayed position using the up and down (left and right) arrow keys.
3. Pressing the left (down) arrow key switches to the historical trend screen with shifted waveforms.

Display the current trend data and the historical trend data

Displays the current display data on the upper (right) half of the screen and the historical trend on the lower (left) half of the screen.

1. Pressing the left (down) arrow key displays the current trend and the historical trend.
To return to the previous screen, press the up arrow key.

Displaying the memory information

1. Pressing the DISP/ENTER key displays the screen menu. ([TREND HISTORY] is selected.)
2. Pressing the right arrow key displays the sub menu.
To close the sub menu, press the left arrow key.
3. Select [INFORMATION ON] using the up and down arrow keys.

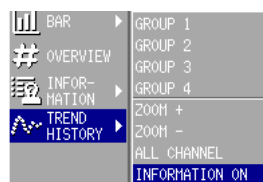

4. Pressing the DISP/ENTER key displays the window with the memory information.
For models with the batch function (/BT1), batch number and lot number information of the display/event data (displayed as a historical trend) is also displayed.

```
File Name (Data Kind): Memory (DISP)
Serial No.           : 12V921453
Application Name     : AP
Supervisor Name      : SUPERVISOR
Manager Name         : MANAGER
Batch Name           : SAMPLE-0010
Start Time           : Jan.03.2000 07:07:52
Start User Name      : user1
End Time             : Jan.03.2000 07:08:46
End User Name        : user1
```

5. To clear the window, press the DISP/ENTER key or one of the arrow keys.

Explanation

Background color of the historical trend

The background color of the historical trend is either black or white, opposite of the background color displayed for the current trend.

Historical Trend

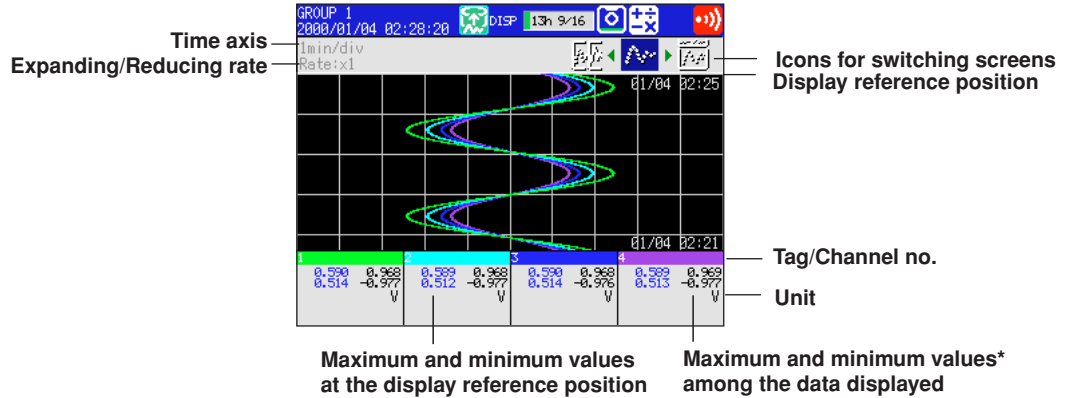

* All digits may not be displayed because of the limitation of the display area.

Historical Trend (Displaying the current trend and the historical trend).

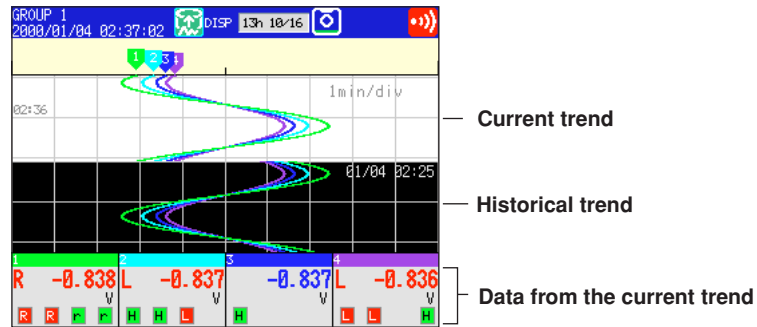

Note

It is possible that not all of the digits of the maximum and minimum values of the computation channel data will be displayed.

5.1 Voltage Input Setting

To measure the DC voltage input or the DC current input using an external shunt resistor, follow the procedures below to set the voltage input. The range cannot be changed while data acquisition or computation is in progress.

Procedure

- These procedures are carried out in the setting mode.
- Use the arrow keys to move the cursor (blue) to the appropriate parameter. (The parameters that cannot be changed are grayed.)
- The possible selections are displayed at the bottom of the screen. Select using the soft keys.
- The parameter boxes that are changed are displayed in yellow. By confirming the new settings, they change back to white.

Press .

To display the setting screen press the soft key .

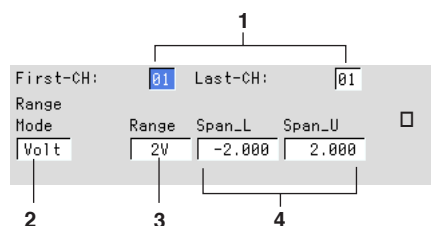

The numbers in front of the operating procedure shown below correspond to the numbers in the above figure.

1. First channel and last channel
Select the desired channels.
2. Mode
Set the mode to [Volt].
3. Range
Set the input range.
4. Upper and lower limits of span
Set the upper and lower limits of the display span.
Pressing the [Input] soft key displays a window used to enter a numerical value.
Enter a value in the allowed range and press the DISP/ENTER key.
For the procedures related to entering numerical values, see “Entering Numbers” on page 3-21.

Note

Span lower limit and span upper limit cannot be set to the same value.

Confirming operation

To confirm the new settings, press the DISP/ENTER key.
To cancel the new settings, press the ESC key. A window appears for you to confirm the cancellation. Select [Yes] using the arrow keys and press the DISP/ENTER key.

5.1 Voltage Input Setting

Explanation

Measurable range

The following table shows the mode, range, and measurable range.

Mode	Range	Measurable Range
Volt	20 mV	-20.00 to 20.00 mV
	60 mV	-60.00 to 60.00 mV
	200 mV	-200.0 to 200.0 mV
	2 V	-2.000 to 2.000 V
	6 V	-6.000 to 6.000 V
	20 V	-20.00 to 20.00 V
	50 V	-50.00 to 50.00 V

DC current input

An external shunt resistor is connected to the input terminal to convert a current signal to a voltage signal. The shunt resistors in the following table can be provided. A 250 Ω shunt resistor, for example, is used to convert a 4 to 20 mA to a 1 to 5 V.

Name	Model Code	Specification
Shunt resistors (for screw terminals)	4159 20	250 Ω \pm 0.1%
	4159 21	100 Ω \pm 0.1%
	4159 22	10 Ω \pm 0.1%
Shunt resistors (for clamped terminals)	4389 20	250 Ω \pm 0.1%
	4389 21	100 Ω \pm 0.1%
	4389 22	10 Ω \pm 0.1%

5.2 Thermocouple (TC)/Resistance Temperature Detector (RTD) Setting

To measure TC and RTD signals, follow the procedures below to set the input range. The range cannot be changed while data acquisition or computation is in progress.

Procedure

- These procedures are carried out in the setting mode.
- Use the arrow keys to move the cursor (blue) to the appropriate parameter. (The parameters that cannot be changed are grayed.)
- The possible selections are displayed at the bottom of the screen. Select using the soft keys.
- The parameter boxes that are changed are displayed in yellow. By confirming the new settings, they change back to white.

Press .

To display the setting screen press the soft key .

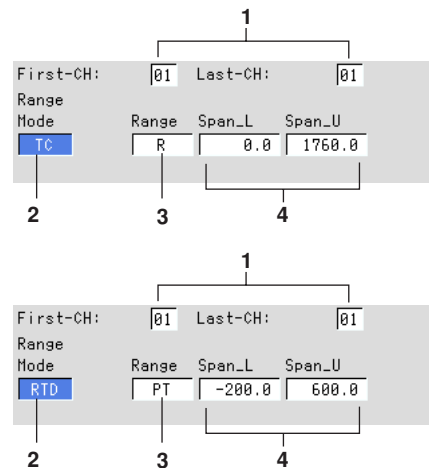

The numbers in front of the operating procedure shown below correspond to the numbers in the above figure.

1. First channel and last channel
Select the desired channels.
2. Mode
Set the mode to [TC] (thermocouple) or [RTD] (resistance temperature detector).
3. Range
Set the type of thermocouple or RTD.
4. Upper and lower limits of span
Set the upper and lower limits of the display span.
Pressing the [Input] soft key displays a window used to enter a numerical value. Enter a value in the allowed range and press the DISP/ENTER key. For the procedures related to entering numerical values, see "Entering Numbers" on page 3-21.

Note

Span lower limit and span upper limit cannot be set to the same value.

5.2 Thermocouple (TC)/Resistance Temperature Detector (RTD) Setting

Confirming operation

To confirm the new settings, press the DISP/ENTER key.

To cancel the new settings, press the ESC key. A window appears for you to confirm the cancellation. Select [Yes] using the arrow keys and press the DISP/ENTER key.

Explanation

Measurable range

The following table shows the mode, range, and measurable range.

Mode	Range	Measurable Range (°C)	Measurable Range (°F)	Note
TC	R	0.0 to 1760.0°C	32 to 3200°F	IEC584, DIN IEC584, JIS C1602-1995
	S	0.0 to 1760.0°C	32 to 3200°F	IEC584, DIN IEC584, JIS C1602-1995
	B	0.0 to 1820.0°C	32 to 3308°F	IEC584, DIN IEC584, JIS C1602-1995
	K	-200.0 to 1370.0°C	-328 to 2498°F	IEC584, DIN IEC584, JIS C1602-1995
	E	-200.0 to 800.0°C	-328.0 to 1472.0°F	IEC584, DIN IEC584, JIS C1602-1995
	J	-200.0 to 1100.0°C	-328.0 to 2012.0°F	IEC584, DIN IEC584, JIS C1602-1995
	T	-200.0 to 400.0°C	-328.0 to 752.0°F	IEC584, DIN IEC584, JIS C1602-1995
	N	0.0 to 1300.0°C	32 to 2372°F	IEC584, DIN IEC584, JIS C1602-1995
	W	0.0 to 2315.0°C	32 to 4199°F	W-5% Re/W-26% Re (Hoskins Mfg.Co.), ASTM E988
	L	-200.0 to 900.0°C	-328.0 to 1652.0°F	Fe-CuNi, DIN 43710
U	-200.0 to 400.0°C	-328.0 to 752.0°F	Cu-CuNi, DIN 43710	
RTD	Pt100	-200.0 to 600.0°C	-328.0 to 1112.0°F	JIS C1604-1989, JIS C1606-1997, IEC751-1995, DIN IEC751-1996
	JPt100	-200.0 to 550.0°C	-328.0 to 1022.0°F	JIS C1604-1989, JIS C1606-1989
	CU1	-200.0 to 300.0°C	-328.0 to 572.0°F	CU10 Ω GE1 (Cuid based on a particular manufacturer)
	CU2	-200.0 to 300.0°C	-328.0 to 572.0°F	CU10 Ω L&N (Cuid based on a particular manufacturer)
	CU3	-200.0 to 300.0°C	-328.0 to 572.0°F	CU10 Ω WEED (Cuid based on a particular manufacturer)
	CU4	-200.0 to 300.0°C	-328.0 to 572.0°F	CU10 Ω BAILAY (Cuid based on a particular manufacturer)
	CU5	-200.0 to 300.0°C	-328.0 to 572.0°F	CU10 Ω α = 0.00392 at 20°C
	CU6	-200.0 to 300.0°C	-328.0 to 572.0°F	CU10 Ω α = 0.00393 at 20°C
	CU25	-200.0 to 300.0°C	-328.0 to 572.0°F	CU25 Ω α = 0.00425 at 0°C

Cu1 to 6, and Cu25 are options.

For the setting procedure of the reference junction compensation and the burnout for the thermocouple input, see section 5.9.

5.3 Digital Input (DI) Setting

To measure the digital input, follow the procedures below to set the input range. The range cannot be changed while data acquisition or computation is in progress.

Procedure

- These procedures are carried out in the setting mode.
- Use the arrow keys to move the cursor (blue) to the appropriate parameter. (The parameters that cannot be changed are grayed.)
- The possible selections are displayed at the bottom of the screen. Select using the soft keys.
- The parameter boxes that are changed are displayed in yellow. By confirming the new settings, they change back to white.

Press .

To display the setting screen press the soft key .

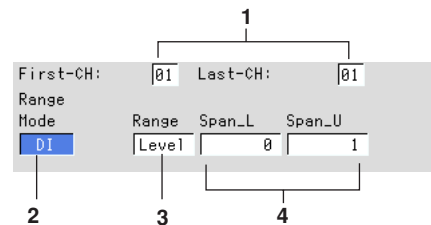

The numbers in front of the operating procedure shown below correspond to the numbers in the above figure.

1. First channel and last channel
Select the desired channels.
2. Mode
Set the mode to [DI].
3. Range
Select [Level] or [Cont] (Contact).
4. Upper and lower limits of span
Set the upper and lower limits of the display span.
Pressing the [Input] soft key displays a window used to enter a numerical value.
Enter 0 or 1 and press the DISP/ENTER key.
For the procedures related to entering numerical values, see “Entering Numbers” on page 3-21.

Note

Span lower limit and span upper limit cannot be set to the same value.

Confirming operation

To confirm the new settings, press the DISP/ENTER key.

To cancel the new settings, press the ESC key. A window appears for you to confirm the cancellation. Select [Yes] using the arrow keys and press the DISP/ENTER key.

5.3 Digital Input (DI) Setting

Explanation

Measurable range

The following table shows the mode, range, and measurable range.

Mode	Range	Measurable Range
DI	Level	0: Less than 2.4 V 1: Greater than or equal to 2.4 V
	Contact	0: Opened 1: Closed

5.4 Difference Computation (Delta) Setting.

To measure the difference between the inputs of two channels, follow the procedures below to set the input range. The difference computation channel displays the computed result of “(the measured value of the difference computation channel) - (the measured value of the reference channel).” Select the input type for the difference computation channel from DC voltage, thermocouple, RTD, and digital input. The range cannot be changed while data acquisition or computation is in progress.

Procedure

- These procedures are carried out in the setting mode.
- Use the arrow keys to move the cursor (blue) to the appropriate parameter. (The parameters that cannot be changed are grayed.)
- The possible selections are displayed at the bottom of the screen. Select using the soft keys.
- The parameter boxes that are changed are displayed in yellow. By confirming the new settings, they change back to white.

Press .

To display the setting screen press the soft key .

First-CH:		01	Last-CH:		01
Range					
Mode	Type	Range	Span_L	Span_U	Ref.CH
Delta	Volt	2V	-2.000	2.000	01
2	3	4	5		6

The numbers in front of the operating procedure shown below correspond to the numbers in the above figure.

1. First channel and last channel
Set the channels that will measure the difference.
2. Mode
Set the mode to [Delta].
3. Type
Select the input type from [Volt], [TC], [RTD], and [DI].
4. Range
If the type is [Volt] enter the input range. If it is [TC] or [RTD] enter the type of TC or RTD. If it is [DI] enter [Level] or [Cont].
5. Upper and lower limits of span
Set the upper and lower limits of the display span.
Pressing the [Input] soft key displays a window used to enter a numerical value.
Enter a value in the allowed range and press the DISP/ENTER key.
For the procedures related to entering numerical values, see “Entering Numbers” on page 3-21.

Note

- For TC or RTD input, the display span cannot exceed the difference between the maximum and the minimum of the input range.
Example: For TC type L, the measurable range is -200.0 to 900.0°C .
The allowed range of display span: -1100.0 to 1100.0°C .
- For DC voltage input, the display span cannot exceed the measurable range.
- The upper limit and the lower limit cannot be set to the same value.

5.4 Difference Computation (Delta) Setting.

6. Ref. CH
Set the reference channel (see “Explanation”).

Confirming operation

To confirm the new settings, press the DISP/ENTER key.

To cancel the new settings, press the ESC key. A window appears for you to confirm the cancellation. Select [Yes] using the arrow keys and press the DISP/ENTER key.

Explanation

Measurable range

The following table shows the mode, type, range, and measurable range.

Mode	Type	Range	Measurable Range	
Delta	Volt	20 mV	-20.00 to 20.00 mV	
		60 mV	-60.00 to 60.00 mV	
		200 mV	-200.0 to 200.0 mV	
		2 V	-2.000 to 2.000 V	
		6 V	-6.000 to 6.000 V	
		20 V	-20.00 to 20.00 V	
		50 V	-50.00 to 50.00 V	
Delta	TC	R	-1760.0 to 1760.0°C	-3168 to 3168°F
		S	-1760.0 to 1760.0°C	-3168 to 3168°F
		B	-1820.0 to 1820.0°C	-3276 to 3276°F
		K	-1570.0 to 1570.0°C	-2826 to 2826°F
		E	-1000.0 to 1000.0°C	-1800.0 to 1800.0°F
		J	-1300.0 to 1300.0°C	-2340.0 to 2340.0°F
		T	-600.0 to 600.0°C	-1080.0 to 1080.0°F
		N	-1300.0 to 1300.0°C	-2340 to 2340°F
		W	-2315.0 to 2315.0°C	-4167 to 4167°F
		L	-1100.0 to 1100.0°C	-1980.0 to 1980.0°F
		U	-600.0 to 600.0°C	-1080.0 to 1080.0°F
Delta	RTD	Pt100	-800.0 to 800.0°C	-1440.0 to 1440.0°F
		JPt100	-750.0 to 750.0°C	-1350.0 to 1350.0°F
		CU1 to 6 (CU10)	-500.0 to 500.0°C (option)	-900.0 to 900.0°F
		CU25	-500.0 to 500.0°C (option)	-900.0 to 900.0°F
Delta	DI	Level	-1 to 1	
		Contact	-1 to 1	

The relationship with the reference channel

Even if the input type or the measurement range of the difference computation channel and the reference channel is not the same, the difference computation is performed according to the following rules.

- When the decimal position between the reference channel and the difference computation channel is different, the measured value of the reference channel is adjusted to the decimal position of the measured value of the difference computation channel to make the computation.
Example: When the measured value of the difference computation channel is 10.00 and the measured value of the reference channel is 100.0, the computation result becomes $10.00 - 100.0 = -90.00$.
- When the units for the reference channel and the difference computation channel are different, the measured value is not adjusted.
Example: When the measured value of the difference computation channel is 10.00 V and the measured value of the reference channel is 5.00 mV, the computation result becomes $10.00 \text{ V} - 5.00 \text{ mV} = 5.00 \text{ V}$.
- When the reference channel is set to [Scale] or [Sqrt], the computation uses the scaled values.

5.5 Scaling Setting

For DC voltage, thermocouple, RTD and digital input, the measured values can be scaled to a value in the appropriate unit and displayed. Set the upper and lower limits of the display span, the upper and lower limits after scaling, and the unit. The range cannot be changed while data acquisition or computation is in progress.

Procedure

- These procedures are carried out in the setting mode.
- Use the arrow keys to move the cursor (blue) to the appropriate parameter. (The parameters that cannot be changed are grayed.)
- The possible selections are displayed at the bottom of the screen. Select using the soft keys.
- The parameter boxes that are changed are displayed in yellow. By confirming the new settings, they change back to white.

Press .

To display the setting screen press the soft key .

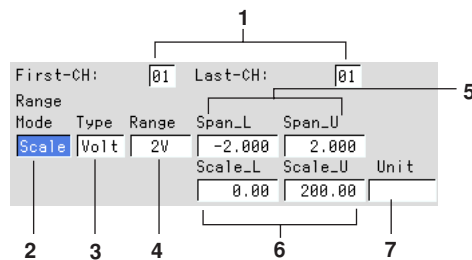

The numbers in front of the operating procedure shown below correspond to the numbers in the above figure.

1. First channel and last channel
Select the desired channels.
2. Mode
Set the mode to [Scale].
3. Type
Select the input type from [Volt], [TC], [RTD], and [DI].
4. Range
Select the input range using the soft keys according to the input type.
5. Upper and lower limits of span
Set the upper and lower limits of the display span.
Pressing the [Input] soft key displays a window used to enter a numerical value.
Enter a value in the allowed range and press the DISP/ENTER key.
For the procedures related to entering numerical values, see "Entering Numbers" on page 3-21.

Note

Span lower limit and span upper limit cannot be set to the same value.

5.5 Scaling Setting

6. Upper and lower limits of scale

Set the upper and lower limits of the scale.

Enter a value in the allowed range using the same method as step 5.

- Allowed range: -30000 to 30000
- Decimal position

The decimal can be set in the following positions:

“□.□□□□” “□□.□□□□” “□□□.□□□□” “□□□□.□□□□” “□□□□□□□□”

- The decimal position is determined by the scale lower limit setting.

Note

- Scale lower limit and scale upper limit cannot be set to the same value.
 - The DX100L converts the measured data within a value span derived by removing the decimal from the scaling upper and lower limits. In other words, conversion is performed by using a span of 10 if the scale setting is -5 to 5, and 100 if the scale setting is -5.0 to 5.0. The resolution of the value derived by using a span of 10 is coarser than the value derived using a span of 100. Because the display becomes rough, set this value so that it is greater than 100.
-

7. Unit

Set the unit.

Pressing the [Input] soft key displays a window used to enter a character string.

Enter the unit (up to 6 alphanumeric characters) and press the DISP/ENTER key.

For the procedures related to entering character strings, see “Entering Characters” on page 3-22.

Confirming operation

To confirm the new settings, press the DISP/ENTER key.

To cancel the new settings, press the ESC key. A window appears for you to confirm the cancellation. Select [Yes] using the arrow keys and press the DISP/ENTER key.

Explanation

Measurable Range

See sections listed below.

Mode	Type	Range/Measurable Range
Scale	Volt	See section 5.1, “Voltage Input Setting.”
	TC	See section 5.2, “Thermocouple (TC)/Resistance Temperature Detector (RTD) Setting.”
	RTD	See section 5.2, “Thermocouple (TC)/Resistance Temperature Detector (RTD) Setting.”
	DI	See section 5.3, “Digital Input (DI) Setting.”

5.6 Square Root Computation Setting

Computes the square root of the DC voltage input. The result can be scaled to a value in the appropriate unit and displayed. Set the upper and lower limits of the display span, the upper and lower limits after scaling, and the unit. The range cannot be changed while data acquisition or computation is in progress.

Procedure

- These procedures are carried out in the setting mode.
- Use the arrow keys to move the cursor (blue) to the appropriate parameter. (The parameters that cannot be changed are grayed.)
- The possible selections are displayed at the bottom of the screen. Select using the soft keys.
- The parameter boxes that are changed are displayed in yellow. By confirming the new settings, they change back to white.

Press .

To display the setting screen press the soft key .

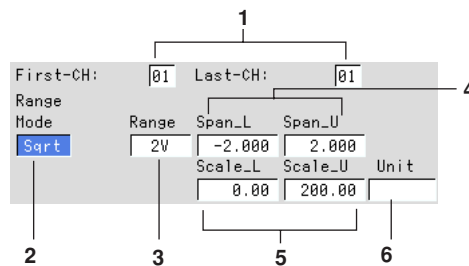

The numbers in front of the operating procedure shown below correspond to the numbers in the above figure.

1. First channel and last channel
Select the desired channels.
2. Mode
Set the mode to [Sqrt].
3. Range
Select the input range from [20 mV], [60 mV], [200 mV], [2 V], [6 V], [20 V], and [50 V].
4. Upper and lower limits of span
Set the upper and lower limits of the display span.
Pressing the [Input] soft key displays a window used to enter a numerical value. Enter a value in the allowed range and press the DISP/ENTER key. For the procedures related to entering numerical values, see “Entering Numbers” on page 3-21.

Note

Span lower limit and span upper limit cannot be set to the same value.

5.6 Square Root Computation Setting

5. Upper and lower limits of scale

Set the upper and lower limits of the scale.

Enter a value in the allowed range using the same method as step 4.

- Allowed range: –30000 to 30000
- Decimal position

The decimal can be set in the following positions:

“□.□□□□” “□□.□□□□” “□□□.□□□□” “□□□□.□□□□” “□□□□□□□□”

- The decimal position is determined by the scale lower limit setting.

Note

- Scale lower limit and scale upper limit cannot be set to the same value.
 - The DX100L converts the measured data within a value span derived by removing the decimal from the scaling upper and lower limits. In other words, conversion is performed by using a span of 10 if the scale setting is –5 to 5, and 100 if the scale setting is –5.0 to 5.0. The resolution of the value derived by using a span of 10 is coarser than the value derived using a span of 100. Because the display becomes rough, set this value so that it is greater than 100.
-

6. Unit

Set the unit.

Pressing the [Input] soft key displays a window used to enter a character string.

Enter the unit (up to 6 alphanumeric characters) and press the DISP/ENTER key. For the procedures related to entering character strings, see “Entering Characters” on page 3-22.

Confirming operation

To confirm the new settings, press the DISP/ENTER key.

To cancel the new settings, press the ESC key. A window appears for you to confirm the cancellation. Select [YES] using the arrow keys and press the DISP/ENTER key.

Explanation

For the range and measurable range, see section 5.1, “Voltage Input Setting.”

Computing equation

The DX100L uses the following square-root computation:

Using the following definitions:

- Vmin: Lower limit of span
- Vmax: Upper limit of span
- Fmin: Lower limit of scale
- Fmax: Upper limit of scale
- Vx: Input voltage
- Fx: Scaling value

$$F_x = (F_{max} - F_{min}) \sqrt{\frac{V_x - V_{min}}{V_{max} - V_{min}}} + F_{min}$$

When the value inside the square root is negative,

when Fmin < Fmax: “-*****,” or

when Fmin > Fmax: “+*****”

is displayed.

5.7 Skip Setting

These channels will not be measured or displayed. The range cannot be changed while data acquisition or computation is in progress.

Procedure

- These procedures are carried out in the setting mode.
- Use the arrow keys to move the cursor (blue) to the appropriate parameter. (The parameters that cannot be changed are grayed.)
- The possible selections are displayed at the bottom of the screen. Select using the soft keys.
- The parameter boxes that are changed are displayed in yellow. By confirming the new settings, they change back to white.

Press .

To display the setting screen press the soft key

#1

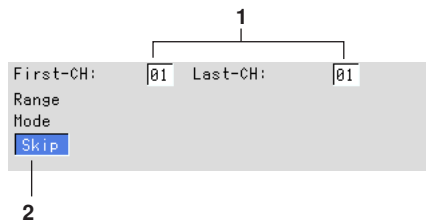

The numbers in front of the operating procedure shown below correspond to the numbers in the above figure.

1. First channel and last channel
Select the desired channels.
2. Mode
Set the mode to [Skip].

Confirming operation

To confirm the new settings, press the DISP/ENTER key.

To cancel the new settings, press the ESC key. A window appears for you to confirm the cancellation. Select [Yes] using the arrow keys and press the DISP/ENTER key.

5.8 Input Filter and Moving Average Setting

Set the input filter (for DX102L/DX104L, low pass filters) or the moving average of the input (for DX106L/DX112L).

Procedure

- These procedures are carried out in the setting mode.
- Use the arrow keys to move the cursor (blue) to the appropriate parameter. (The parameters that cannot be changed are grayed.)
- The possible selections are displayed at the bottom of the screen. Select using the soft keys.
- The parameter boxes that are changed are displayed in yellow. By confirming the new settings, they change back to white.

Press



To display the setting screen press the soft key

#2

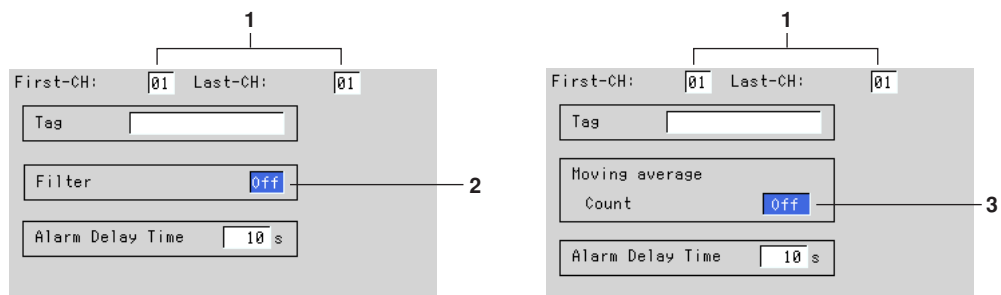

The numbers in front of the operating procedure shown below correspond to the numbers in the above figure.

1. First channel and last channel
Select the desired channels. (For the channels set here, [Tag] and [Alarm Delay Time] are also simultaneously set.)

Input Filter Setting (for DX102L/DX104L)

2. Filter
Select [Off] or set the time constant of the filter.

Moving Average Setting (for DX106L/DX112L)

3. Moving Average - Count
Select [Off] or set the number of data points for the moving average.

Note

Regardless of this setting, filter and moving average operations are not performed for the digital inputs (DI).

Confirming operation

To confirm the new settings, press the DISP/ENTER key.

To cancel the new settings, press the ESC key. A window appears for you to confirm the cancellation. Select [Yes] using the arrow keys and press the DISP/ENTER key.

Explanation

The following table shows the values.

Filter/Moving Average	Value	Description
Filter	Off	Do not use the filter
	2 s	Filter time constant 2 s
	5 s	Filter time constant 5 s
	10 s	Filter time constant 10 s
Moving Average	Off	Do not use moving average.
	2 to 16	Number of data samples for the moving average

5.9 Setting the A/D Integration Time, Scan Interval, Burnout, and Reference Junction Compensation (Basic Setting Mode)

Set the integration time of the A/D converter, scan interval, thermocouple input burnout, and reference junction compensation (RJC).

Procedure

- These procedures are carried out in the basic setting mode.
- Use the arrow keys to move the cursor (blue) to the appropriate parameter.
- The possible selections are displayed at the bottom of the screen. Select using the soft keys.
- The parameter boxes that are changed are displayed in yellow. By confirming the new settings, they change back to white.

Press .

Press  for 3 seconds. The menu screen for the basic setting mode appears.

To display the setting screen press the soft key .

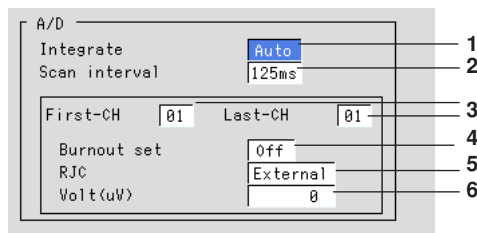

The numbers in front of the operating procedure shown below correspond to the numbers in the above figure.

Setting the integration time of the A/D converter

1. Integrate
Select from [Auto], [50 Hz], [60 Hz], and [100 ms] using soft keys.
DX102L/DX104L: Auto/50 Hz/60 Hz
DX106L/DX112L: Auto/50 Hz/60 Hz/100 ms
[Auto]: automatically switches 20/16.7 ms (fixed to 20 ms on DC power supply models)
[50 Hz]: fixed to 20 ms
[60 Hz]: fixed to 16.7 ms
[100 ms]: fixed to 100 ms (the scan interval is 2 s)

Setting the scan interval

2. Scan interval
Input signals are scanned at every scan interval. For the models with computation function (/M1), the computation carried out at every scan interval.
DX102L/DX104L: 125 ms/250 ms
DX106L/DX112L: 1 s/2 s (when the A/D integration time is 100 ms, 2 s only)

Setting the thermocouple input burnout and setting the reference junction compensation

This setting is void for all input settings other than the TC.

3. First channel and last channel
Select the desired channels.

5.9 Setting the A/D Integration Time, Scan Interval, Burnout, and Reference Junction Compensation (Basic Setting Mode)

4. Burnout
Select from [Off], [Up], and [Down].
[Off]: Disable the burnout function.
[Up]: When the thermocouple burns out, the measured result is set to positive over range “+*****.”
[Down]: When the thermocouple burns out, the measured result is set to negative over range “-*****”.
5. RJC
Set [External] or [Internal].
[External]: Use the external RJC.
[Internal]: Use the RJC of the DX100L.
6. Volt (μV)
If [External] is selected, set the reference junction compensation voltage to add to the input.
Pressing the [Input] soft key displays a window used to enter the voltage. Enter a value ($-20000 \mu\text{V}$ to $20000 \mu\text{V}$, initial value is $0 \mu\text{V}$) and press the DISP/ENTER key. For the procedures related to entering numerical values, see “Entering Numbers” on page 3-21.

Confirming operation

To confirm the new settings, press the DISP/ENTER key.

To cancel the new settings, press the ESC key. A window appears for you to confirm the cancellation. Select [Yes] using the arrow keys and press the DISP/ENTER key.

Explanation

The integration time of the A/D converter

The DX100L uses an A/D converter to convert the input signal to a digital signal. The A/D converter operates at an integral time of 16.7 ms (60 Hz), 20 ms (50 Hz), or 100 ms. By setting the integration time to match the frequency of the power supply being used, power supply frequency noise can be minimized.

Burnout of Thermocouple Input

When the alarm is set to detect positive or negative over range, the occurrence of burnout of thermocouple can be displayed as an alarm.

Turn the burnout function OFF when connecting the input wires in parallel with other devices.

Reference Junction Compensation of Thermocouple Input

When using the reference junction compensation of the DX100L, see “Precautions to be taken while wiring” in section 2.3, “Input Signal Wiring.”

When using the external reference junction compensation, set an appropriate reference junction compensation voltage. As in the example in the following figure, if the reference junction temperature for the external reference junction compensation is $T_0 \text{ }^\circ\text{C}$, set the thermoelectromotive force of the $0 \text{ }^\circ\text{C}$ reference for $T_0 \text{ }^\circ\text{C}$ as the reference junction compensation voltage.

An example of External reference junction compensation

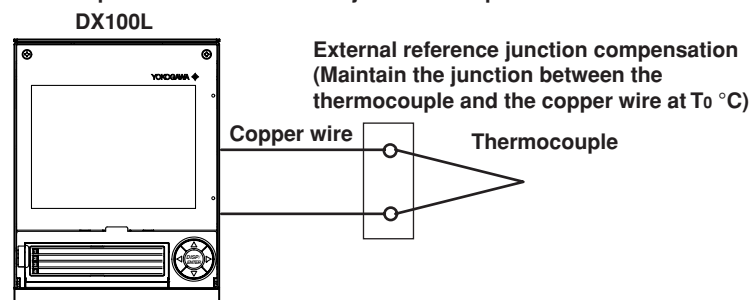

6.1 Releasing the Alarm Indication and Output Relay (Option)

This section describes the procedures to release the alarm indication and the output relay when the behavior of the indicator or the output relay is set to [hold]. The indicator or output relay condition varies depending on the timing at which the alarm release operation is carried out.

Procedure

Operation using the FUNC key

This operation is carried out in the operation mode.

1. Press the FUNC key to display the soft key menu.
2. To release the alarm indication and the output relay, press the [Alarm ACK] soft key.



Operation using the USER key

This is an operation carried out when [Alarm ACK] is assigned to the USER key.

1. To release the alarm indication and the output relay, press the USER key.

Explanation

- The indications and output relays generated by all alarms are released.
- The release operation is void if the behavior of the indicator or the output relay is set to [non-hold].
- The release operation can be executed via remote control (option) or via communications.

Alarm indication

The alarm condition can be confirmed with the alarm icon in the status display section and the alarm indication on the operation screen such as the trend display. The indicator pattern varies depending on the hold/non-hold setting.

- **The alarm icon in the status display section**

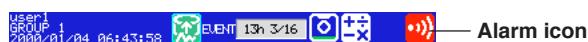

Indicator Hold/Non-hold	Alarm	Alarm Indication
Non-hold	Activated	Red icon
	Released	No icon displayed
Hold	Activated	Blinking red icon (Stops blinking with alarm ACK)
	Released	Blinking green icon (icon disappears with alarm ACK)

6.1 Releasing the Alarm Indication and Output Relay (Option)

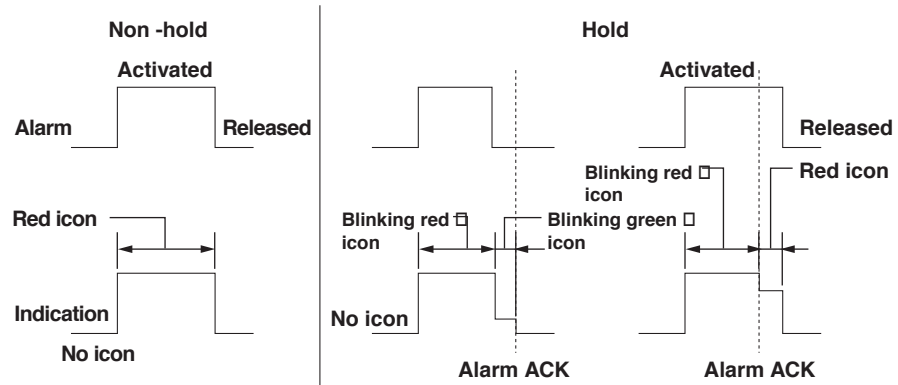

- Alarm indication in the trend display

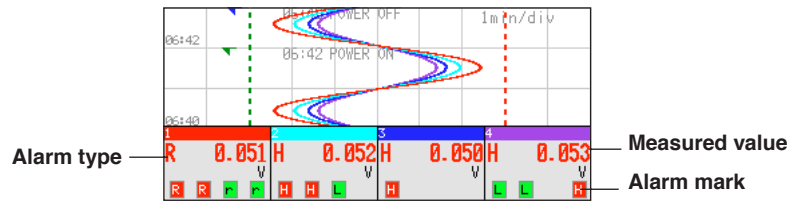

Indicator Hold/Non-Hold	Alarm	Alarm Indication
Non-hold	Activated	Alarm mark, alarm type, measured values: All red
	Released	Alarm mark: Green color Alarm type: Not displayed Measured value: Blue color
Hold	Activated	Alarm mark: Blinks in red (Stops blinking with alarm ACK) Alarm type, measured value: Displayed in red
	Released	Alarm mark: Blinks in green (Stops blinking with alarm ACK) Alarm type: Not displayed Measured value: Blue

- Alarm indication in the digital display

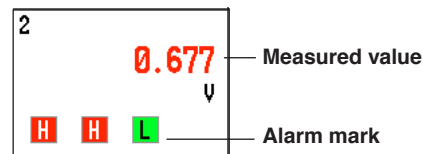

Indicator Hold/Non-Hold	Alarm	Alarm Indication
Non-hold	Activated	Alarm mark, measured values: All red
	Released	Alarm mark: Green Measured value: Blue
Hold	Activated	Alarm mark: Blinks in red (Stops blinking with alarm ACK) Measured value: Red
	Released	Alarm mark: Blinks in green (Stops blinking with alarm ACK) Measured value: Blue

• Alarm indication in the bar graph display

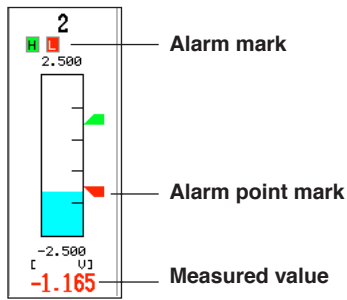

Indicator Hold/Non-Hold	Alarm	Alarm Indication
Non-hold	Activated	Alarm mark, alarm point mark, and measured values: All red
	Released	Alarm mark: Green Alarm point mark: Green Measured value: Blue
Hold	Activated	Alarm mark: Blinks in red (Stops blinking with alarm ACK) Alarm point, measured values: Red
	Released	Alarm mark: Blinks in green (Stops blinking with alarm ACK) Alarm point mark: Green Measured value: Blue

• Alarm indication in the overview display

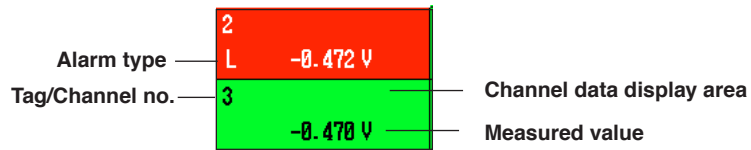

Indicator Hold/Non-Hold	Alarm	Alarm Indication
Non-hold	Activated	Channel display area: Red Channel (tag), alarm type, and measured values: All white
	Released	Channel display area: Green Channel (tag) and measured value: Black Alarm type: Not displayed
Hold	Activated	Channel display area: Red Channel (tag): Blinks in white (Stops blinking with alarm ACK) Alarm type and measured value: White
	Released	Channel display area: Green Channel (tag): Blinks in black (Stops blinking with alarm ACK) Alarm type: Not displayed Measured value: Black

6.1 Releasing the Alarm Indication and Output Relay (Option)

- Alarm Summary Display

(006/006) Channel	Type	Alarm IN Time	Alarm OUT Time
1	1H	Jan.09 01:13:13	Jan.09 01:13:33
1	2L	Jan.09 01:12:14	Jan.09 01:12:25
3	1H	Jan.09 01:11:07	Jan.09 01:11:09
3	1H	Jan.09 01:10:58	Jan.09 01:11:05
1	1H	Jan.09 01:10:54	Jan.09 01:11:24
1	2L	Jan.09 01:10:03	Jan.09 01:10:18

Mark Alarm Information

Indicator Hold/Non-Hold	Alarm	Alarm Indication
Non-hold	Activated	Displays alarm information Mark: Red
	Released	Mark: Green
Hold	Activated	Displays alarm information Mark: Blinks in red (Stops blinking with alarm ACK)
	Released	Mark: Blinks in green (Stops blinking with alarm ACK)

Alarm output relay (option)

Relay Hold/Non-Hold	Alarm	Alarm Indication
Non-hold	Activated	Active
	Released	Idle
Hold	Activated	Active (temporarily suspend with alarm ACK)
	Released	Idle with alarm ACK

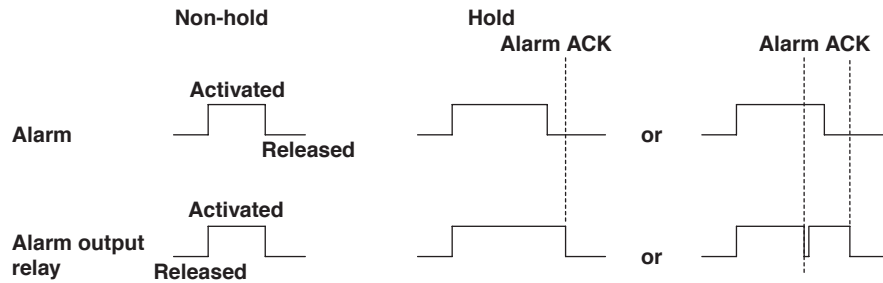

Note

When the basic setting mode is entered, the activated/released condition of the previous alarm output relay is held. (Alarm detection is not carried out in the basic setting mode, and you cannot release the alarm output relay.)

6.2 Alarm Setting

This section describes the procedures related to setting the alarm specification on each channel. The auxiliary alarm function are set in the basic setting mode. (See section 6.4)

Note

- Set the measurement range before setting the alarm.
- All of the alarm settings of a channel are canceled in the following cases:
 - When the input type is changed (Volt, TC, etc.).
 - When the input range is changed.
 - When the upper and lower limits of the span or scale are changed on channels that are set to scaling or square root computation (including changes in the decimal point position).
- If the range setting is set to [Skip], alarm setting is not possible. (The alarm setting boxes are grayed in this case.)

Procedure

- These procedures are carried out in the setting mode.
- Use the arrow keys to move the cursor (blue) to the appropriate parameter. (The parameters that cannot be changed are grayed.)
- The possible selections are displayed at the bottom of the screen. Select using the soft keys.
- The parameter boxes that are changed are displayed in yellow. Once new settings are confirmed, they change back to white.

Press .

To display the setting screen press the soft key .

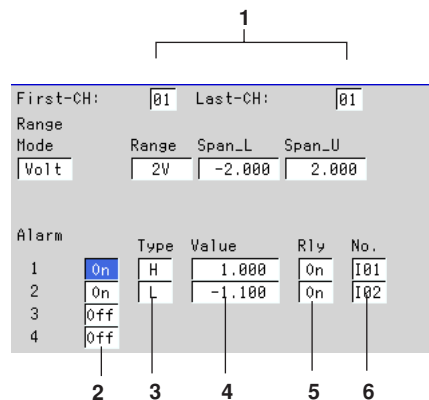

The numbers in front of the operating procedure shown below correspond to the numbers in the above figure.

1. First channel and last channel
Select the desired channels. (For the channels set here, [Range] is also simultaneously set.)
2. On/Off
When the alarm is turned on, [Type], [Value], and [Relay On/Off] are displayed.
3. Type
Set the alarm type. For the alarm types, see "Explanation."

Note

If you select delay alarm (T or t) for the alarm type, you must set the alarm delay period. See section 6.3.

4. Value
Enter the value at which the alarm is activated.
Pressing the [Input] soft key displays a window used to enter a numerical value.
Enter a value in the allowed range and press the DISP/ENTER key.
For the procedures related to entering numerical values, see “Entering Numbers” on page 3-21.
- 5.* Relay On/Off
Set whether or not to activate the output relay (On/Off). When turned ON, the output relay number box appears.
- 6.* Number
Set the output relay number. For the correspondence between the output relay number and the output relay position, see section 2.4, “Alarm Output Wiring (/AR1, /AR2, /A3 Option).”

* When the alarm output relay option is not installed, these settings are void.

Confirming operation

To confirm the new settings, press the DISP/ENTER key.
To cancel the new settings, press the ESC key. A window appears for you to confirm the cancellation. Select [Yes] using the arrow keys and press the DISP/ENTER key.

Explanation

Alarm type

The following eight types of alarm type are available.

Name	Symbol	Description
Upper limit alarm	H	An alarm occurs when the measured value becomes greater than or equal to the alarm value.
Lower limit alarm	L	An alarm occurs when the measured value becomes smaller than or equal to below the alarm value.
Difference upper limit alarm ^{*1}	h	An alarm occurs when the difference between the measured values of two channels becomes greater than or equal to the alarm value.
Difference lower limit alarm ^{*1}	l	An alarm occurs when the difference between the measured values of two channels becomes smaller than or equal to the alarm value.
Upper limit on rate-of-change alarm ^{*2}	R	The amount of change of the measured values over a certain time interval is checked. An alarm occurs when the amount of increase becomes greater than or equal to the specified value (see section 6.4). The time interval is specified using a number of measurements.

Lower limit on rate-of-change alarm* ²	r	The amount of change of the measured values over a certain time interval is checked. An alarm occurs when the amount of decrease becomes greater than or equal to the specified value (see section 6.4). The time interval is specified using a number of measurements.
Delay upper limit alarm	T	An alarm occurs when the measured value remains above or equal to the alarm value for the specified time period (delay period, see section 6.3, "Setting the Alarm Delay Period.").
Delay lower limit alarm	t	An alarm occurs when the measured value remains below or equal to the alarm value for the specified time period (delay period, see section 6.3, "Setting the Alarm Delay Period.").

*1 Can be specified only on difference computation channels.

*2 Can be specified only on measurement channels.

6.3 Setting the Alarm Delay Period

Set the alarm delay period for delay upper/lower limit alarm.

Procedure

- These procedures are carried out in the setting mode.
- Use the arrow keys to move the cursor (blue) to the appropriate parameter. (The parameters that cannot be changed are grayed.)
- The possible selections are displayed at the bottom of the screen. Select using the soft keys.
- The parameter boxes that are changed are displayed in yellow. Once new settings are confirmed, they change back to white.

Press .

Setting on a measurement channel

To display the setting screen press the soft key .

Setting on a computation channel (option)

Twice press the soft key .

To display the setting screen press the soft key .

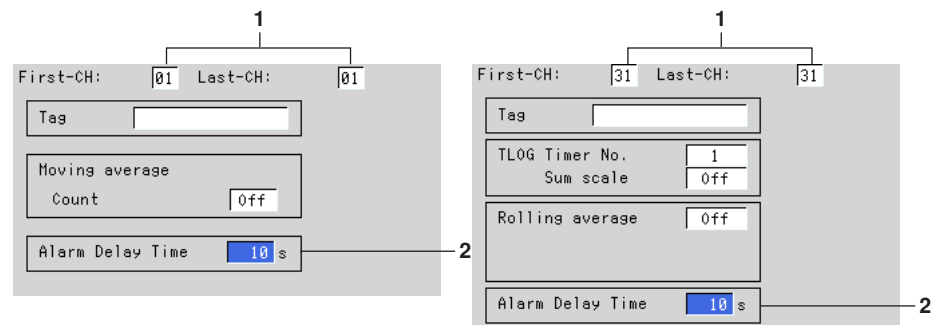

The numbers in front of the operating procedure shown below correspond to the numbers in the above figure.

1. First channel and last channel
Select the desired channels. (For the channels set here, [Tag], [Moving Average] or [Filter] for measurement channels, and [Tag], [TLOG] or [Rolling Average] for computation channels are also simultaneously set.)
2. Alarm delay period
Pressing the [Input] soft key displays a window used to enter the alarm delay period. Enter an integer value in the range 1 to 3600 s and press the DISP/ENTER key. Procedures related to entering numerical values, see “Entering Numbers” on page 3-21.
If the scan interval is 2 s and you set an odd value for the alarm delay period, it will operate at the specified period + 1 s.
Example: If the alarm delay period is set to 5 s, it will operate at 6 s.

Confirming operation

To confirm the new settings, press the DISP/ENTER key.

To cancel the new settings, press the ESC key. A window appears for you to confirm the cancellation. Select [Yes] using the arrow keys and press the DISP/ENTER key.

Explanation

Operation of the delay upper/lower limit alarm

For the operation of the delay upper/lower limit alarm, see section 1.5. This section will describe special cases of its operation.

- **When delay alarm is set on a computation channel and the computation is stopped**

If the computation is stopped in a condition in which the computed value is exceeding the alarm setting, the alarm is turned ON after the specified period (delay period) elapses.

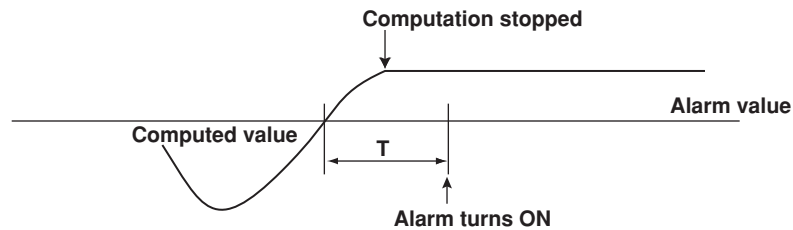

- **Delay alarm when a power failure occurs**

Alarm detection is reset upon a power failure. It restarts the operation after the power recovers.

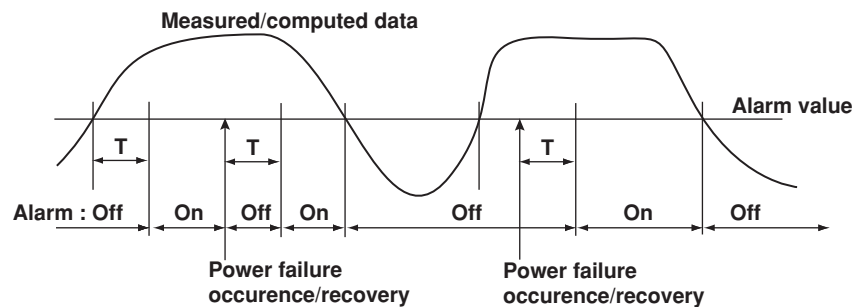

- **Operation when the alarm setting is changed**

- **If a new delay alarm is set**

The alarm detection starts at that time. It is unaffected by the conditions existing before the alarm is set.

- **If the alarm setting of a preexisting delay alarm is changed**

- If an alarm is not occurring at the time of the change, alarm detection starts at the new setting.
- If an alarm is occurring at the time of the change and the alarm type is set to delay upper limit alarm, the alarm continues as long as the input is above or equal to the new setting. If the input is below the new setting, the alarm turns OFF. If the alarm type is set to delay lower limit alarm, the alarm continues as long as the input is below or equal to the new setting. If the input is above the new setting, the alarm turns OFF.

6.4 Setting the Auxiliary Alarm Function (Basic Setting Mode)

Procedure

- These procedures are carried out in the basic setting mode.
- Use the arrow keys to move the cursor (blue) to the appropriate parameter.
- The possible selections are displayed at the bottom of the screen. Select using the soft keys.
- The parameter boxes that are changed are displayed in yellow. Once new settings are confirmed, they change back to white.

Press .

Press  for 3 seconds. The menu screen for the basic setting mode appears.

To display the setting screen press the soft key .

Alarm			
Reflash	Off		1
Relay AND	None		2
Action	Energize		3
Behavior	Nonhold		4
Indicator	Nonhold		5
Rate of change			
Increase	1	}	6
Decrease	1		
Hysteresis	0n		7

The numbers in front of the operating procedure shown below correspond to the numbers in the above figure.

Setting reflash

1. Reflash
Select [On] or [Off].
[On]: Use reflash function
[Off]: Not use reflash function

Setting the AND/OR logic of output relays

2. Relay - AND
Select the relays that are to use the AND logic. Set the last relay that is to use the AND logic. The relays beyond this relay will use the OR logic.
Select from [None], [I01] (I01 only), [I01 - I02] (I01 and I02), ... , and [I01 - I06] (I01 to I06). The setting is valid for relays specified by options.

Setting the output relay operation (energize/de-energize)

3. Relay - Action
Select energize or de-energize using the soft key.

Setting the output relay operation (hold/non-hold)

4. Relay - Behavior
Select hold or non-hold using the soft key.
* When the alarm output relay option is not installed, these settings are void.

Setting the alarm indication operation (hold/non-hold)

5. Indicator
Select hold or non-hold using the soft key.

Setting the interval for the rate-of-change alarm

- 6. Rate of change - Increase, Rate of change - Decrease
 The time interval is specified using a number of sampling times (number of measurements, see section 1.5).
 Select the limit from 1 to 15 using the soft key.

Setting the alarm hysteresis

- 7. Hysteresis
 Select [On] or [Off] using the soft key.
 [On]: The hysteresis is 0.5% of the display span or scale.
 [Off]: No hysteresis

Confirming operation

To confirm the new settings, press the DISP/ENTER key.
 To cancel the new settings, press the ESC key. A window appears for you to confirm the cancellation. Select [Yes] using the arrow keys and press the DISP/ENTER key.

Explanation

Alarm output relay (option)

A contact signal is generated when an alarm occurs. The number of output relays is 2 to 6 points (depends on the specification).

Reflash

When multiple alarms are set to one alarm output relay, this function notifies the succeeding alarms after the first alarm that causes the relay operation. When a succeeding alarm occurs, the output relay temporarily turns OFF. The reflash alarm function is set only to output relays I01, I02, and I03. The initial setting is [Off] (Not use "Reflash").

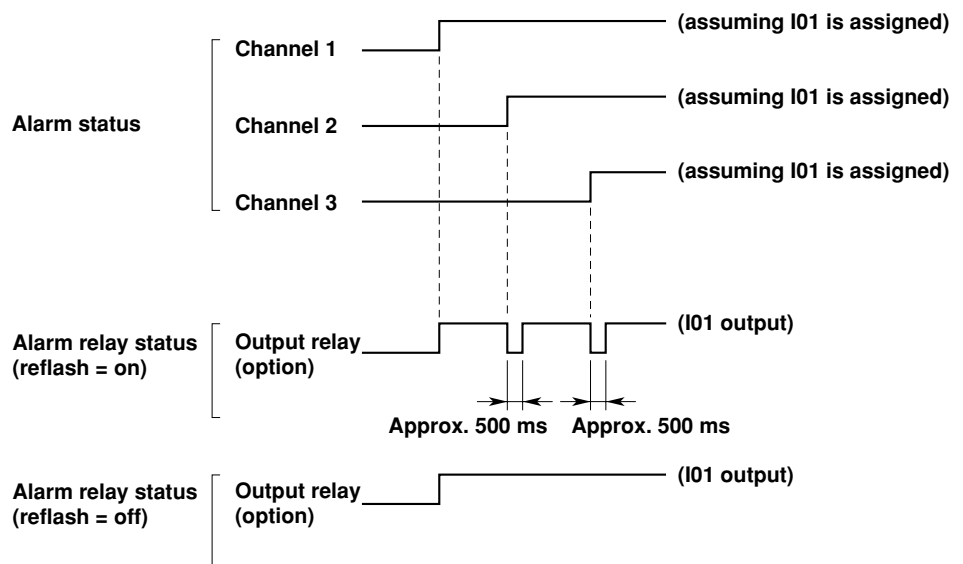

Note

If the reflash alarm is specified, relays I01 to I03 are used as reflash relays regardless of the number of alarm output relays. Therefore, relays I01 to I03 operate as OR logic (see "AND/OR of alarm output relays") and non-hold (see "Hold/Non-hold operation of the alarm output relay") regardless of the settings made in "AND/OR of alarm output relays" and "Hold/Non-hold operation of the alarm output relay."

6.4 Setting the Auxiliary Alarm Function (Basic Setting Mode)

AND/OR of alarm output relays

When sharing an alarm output relay among multiple alarms, you can select from the following conditions that cause the alarm output relay to be activated.

- AND: Activated when all alarms are being generated simultaneously.
- OR: Activated when at least one of the alarms is being generated.

Specify the alarm output relay to operate under the AND condition as in [I01 (first relay) to Ixx (where xx is the relay number)]. The initial setting is set to [None].

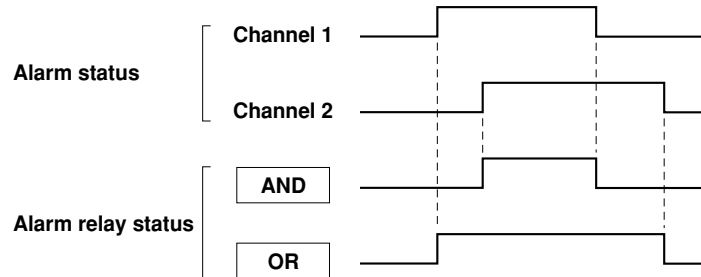

Note

If the reflash alarm is turned ON, I01 to I03 operates as reflash alarms. They are fixed to OR logic operation. Specifying AND produces no effect.

Energize/De-energize operation of the alarm output relay

You can select whether to energize or de-energize the alarm output relay when the alarm occurs. By selecting de-energize, the alarm output relay will operate in the same manner as when the alarm occurs when the power supply is disrupted. Energize or de-energize applies to all alarm output relays. The initial setting is set to [energize].

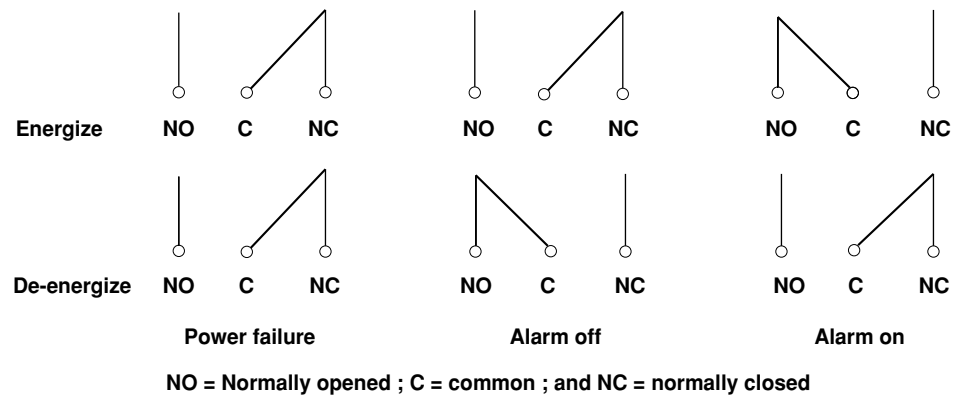

Hold/Non-hold operation of the alarm output relay

When the alarm changes from the activated state to the released state, you can select to

- Turn OFF the output relay in sync with the alarm release (non-hold), or
- Hold the output relay ON till an alarm acknowledge operation is executed (hold)

This applies to all alarm output relays. The initial setting is set to [Nonhold].

• **When set to non-hold**

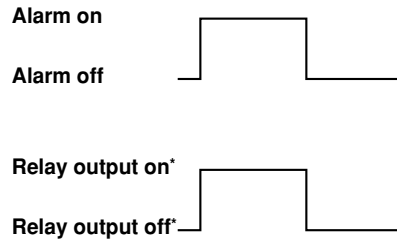

* Shows the status of the normally-opened (NO) contact of the relay. The status is the reverse for the normally-closed contact.

• **When set to hold**

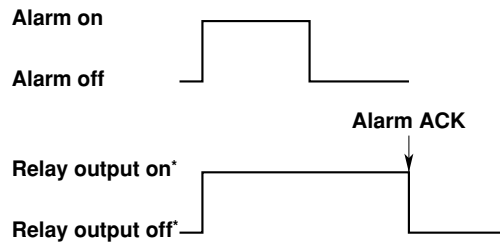

Note

If the reflash alarm is turned ON, I01 to I03 are set to non-hold. Specifying hold produces no effect.

Hold/Non-hold of the alarm indicator

When the alarm changes from the activated state to the released state, you can select to

- Release the alarm indicator in sync with the alarm release (non-hold), or
- Hold the alarm indicator till an alarm acknowledge operation is executed (hold)

The initial setting is [Nonhold].

For details regarding the alarm indicator, see section 6.1.

7.1 Setting Tag Names

Tag names can be displayed in place of channel numbers on the operation screen (trend screen, digital screen, etc.).

The basic setting mode is used to select whether tag names or channel numbers are displayed (see section 7.2).

Tag names are saved to the file along with the data.

Procedure

- These procedures are carried out in the setting mode.
- Use the arrow keys to move the cursor (blue) to the appropriate parameter. (The parameters that cannot be changed are grayed.)
- The possible selections are displayed at the bottom of the screen. Select using the soft keys.
- The parameter boxes that are changed are displayed in yellow. By confirming the new settings, they change back to white.

Press .

Setting on a measurement channel

To display the setting screen press the soft key .

Setting on a computation channel (option)

Twice press the soft key .

To display the setting screen press the soft key .

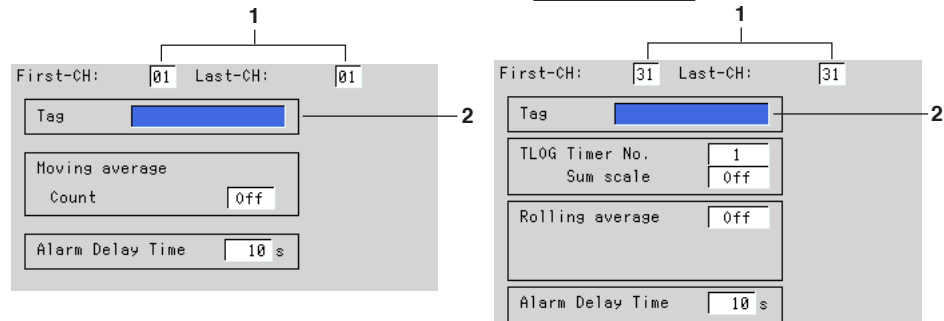

The numbers in front of the operating procedure shown below correspond to the numbers in the above figure.

1. First channel and last channel
Select the desired channels. (For the measurement channels set here, [Moving Average] or [Filter], and [Alarm Delay Time] are also simultaneously set. For the computation channels, [TLOG], [Rolling Average], and [Alarm Delay Time] are also simultaneously set.)
2. Tag
Pressing the [Input] soft key displays a window used to enter the tag name. Enter the tag name (up to 16 alphanumeric characters) and press the DISP/ENTER key. For the procedures related to entering character strings, see "Entering Characters" on page 3-22.

Confirming operation

To confirm the new settings, press the DISP/ENTER key.

To cancel the new settings, press the ESC key. A window appears for you to confirm the cancellation. Select [Yes] using the arrow keys and press the DISP/ENTER key.

7.2 Selecting Tag Display or Channel Number Display (Basic Setting Mode)

Select whether tag names or channel numbers are to be displayed on the operation screen (trend screen, digital screen, etc.). The initial setting is “channel number display.” Tag names are set in the setting mode.

Procedure

- These procedures are carried out in the basic setting mode.
- Use the arrow keys to move the cursor (blue) to the appropriate parameter.
- The possible selections are displayed at the bottom of the screen. Select using the soft keys.
- The parameter boxes that are changed are displayed in yellow. By confirming the new settings, they change back to white.

Press .

Press  for 3 seconds. The menu screen for the basic setting mode appears.

Press the soft key .

To display the setting screen press the soft key .

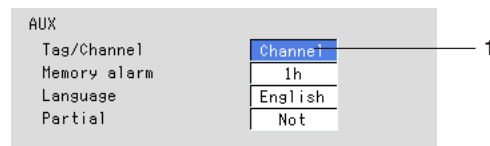

The numbers in front of the operating procedure shown below correspond to the numbers in the above figure.

1. Tag/Channel
Select [Tag] or [Channel].
[Tag]: Display tag names.
[Channel]: Display channel numbers.

Confirming operation

To confirm the new settings, press the DISP/ENTER key.

To cancel the new settings, press the ESC key. A window appears for you to confirm the cancellation. Select [Yes] using the arrow keys and press the DISP/ENTER key.

Note

If a channel is set to display the tag, but the tag name is not entered, the channel will display the channel number.

7.3 Setting the Display Update Rate (Trend)

The time period corresponding to 1 division on the time axis on the trend display is specified. The time axis on the trend display is determined by the display update rate. The sampling interval of the display data is also determined by the display update rate. The display update rate cannot be changed while data sampling is in progress.

Procedure

- These procedures are carried out in the setting mode.
- Use the arrow keys to move the cursor (blue) to the appropriate parameter. (The parameters that cannot be changed are grayed.)
- The possible selections are displayed at the bottom of the screen. Select using the soft keys.
- The parameter boxes that are changed are displayed in yellow. By confirming the new settings, they change back to white.

Press .

To display the setting screen press the soft key .

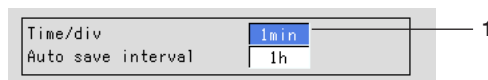

The numbers in front of the operating procedure shown below correspond to the numbers in the above figure.

1. Time/div (Display update rate)
Select the display update rate from 15 s*, 30 s*, 1 min, 2 min, 5 min, 10 min, 20 min, 30 min, 1 h, 2 h, 4 h, and 10 h.
* for DX102L and DX104L only

Confirming operation

To confirm the new settings, press the DISP/ENTER key.

To cancel the new settings, press the ESC key. A window appears for you to confirm the cancellation. Select [Yes] using the arrow keys and press the DISP/ENTER key.

Note

When [Auto save] is set for saving data to the external storage medium, the [Auto save interval] box is displayed under [Time/div]. [Auto save interval] is the interval at which the display data residing in the internal memory are saved to the external storage medium. The selectable values for [Auto save interval] vary depending on the [Time/div] setting. For the setting procedure, see section 8.8.

Explanation

The display data sampling interval and the speed of movement of waveforms along the time axis

The following table shows the display rate, display data sampling interval, and the speed of movement of waveforms along the time axis

Display update rate (/DIV)	15 s*	30 s*	1 min	2 min	5 min	10 min	20 min	30 min	1 h	2 h	4 h	10 h
Display data sampling interval (s)	0.5	1	2	4	10	20	40	60	120	240	480	1200
Speed of movement of waveforms (Estimated value, mm/h)	2376	1188	594	297	119	59	30	20	10	5	2.5	1.0

* for DX102L and DX104L only

7.4 Using Message Strings (Trend)

Arbitrary character strings can be registered. They can be displayed on the trend display and stored along with the display/event data.

- Number of messages: 8
- Number of characters: Up to 16 alphanumeric characters

A list of messages can be displayed on the message summary screen. See section 4.5. For models with the batch function (/BT1 option), messages 1, 2, and 3 can be altered from the operation screen to be used.

Note

When data acquisition to the internal memory is stopped, messages cannot be displayed or written.

For Models without the Batch Function (/BT1 Option)

Procedure

Displaying a message on the trend screen/Writing a message to the internal memory

- **Operation using the FUNC key**

This operation is carried out in the operation mode.

1. Press the FUNC key to display the soft keys.
2. Press the [Message] soft key. Eight soft keys for the messages and a window containing a list of messages are displayed.



3. Press the soft key corresponding to the message you wish to display. A message mark, time, and the message are displayed on the trend screen.

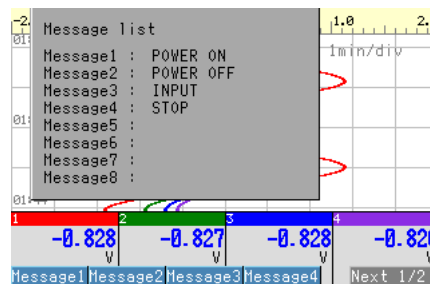

- **Operation using the USER key**

This is an operation carried out when one of [Message1] to [Message8] is assigned to the USER key.

1. Press the USER key, to display a message on the trend display and write a message to the internal memory.

For Models with the Batch Function (/BT1 Option)

Procedure**Displaying a message on the trend screen/Writing a message to the internal memory/Changing message strings**• **Operation using the FUNC key**

This operation is carried out in the operation mode.

1. Press the FUNC key to display the soft keys.
2. Press the [Message] soft key. [Write] and [Set] soft keys are displayed.

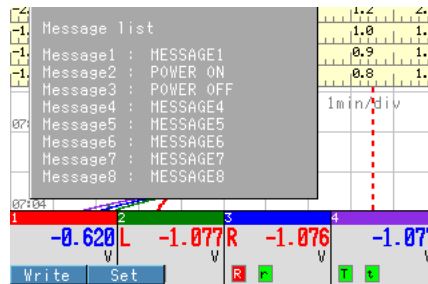
• **Displaying a message on the trend screen/Writing a message to the internal memory**

3. Press the [Write] soft key. Eight soft keys for the messages and a window containing a list of messages are displayed.
4. Press the soft key corresponding to the message you wish to display. A message mark, time, and the message are displayed on the trend display.

• **Changing message strings**

3. Press the [Set] soft key. The [Message1] to [Message3] soft keys and a window containing a list of messages are displayed.
4. Press the soft key of the message to be changed. A window to enter a message string appears.

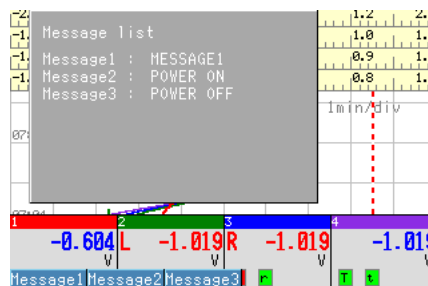

5. Enter the message string (up to 16 alphanumeric characters) and press the DISP/ENTER key. The window used to enter the message string disappears. For the procedures related to entering character strings, see “Entering Character” on page 3-22.
6. Press the FUNC key or the ESC key to erase the window.

• **Operation using the USER key**

The operating procedure is the same as for models without the batch function (/BT1 option)

7.4 Using Message Strings (Trend)

Explanation

Example of Message Display

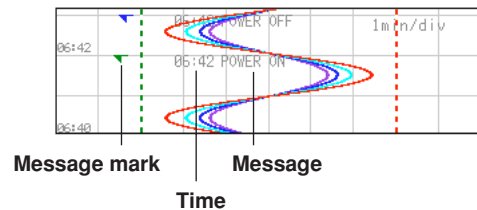

Displayed colors of the message

The message colors on the trend screen are shown below. They cannot be changed.

Message Number	1	2	3	4	5	6	7	8
Displayed Color	Red	Green	Blue	Blue violet	Brown	Orange	Yellow-green	Light blue

7.5 Setting the Message String (Trend)

Procedure

- These procedures are carried out in the setting mode.
- Use the arrow keys to move the cursor (blue) to the appropriate parameter. (The parameters that cannot be changed are grayed.)
- The possible selections are displayed at the bottom of the screen. Select using the soft keys.
- The parameter boxes that are changed are displayed in yellow. By confirming the new settings, they change back to white.

Press .

To display the setting screen press the soft key .

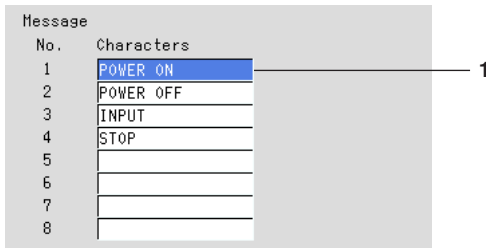

No.	Characters
1	POWER ON
2	POWER OFF
3	INPUT
4	STOP
5	
6	
7	
8	

The numbers in front of the operating procedure shown below correspond to the numbers in the above figure.

1. Characters
Move the cursor to the desired message number.
Pressing the [Input] soft key displays a window used to enter the message string. Enter the message string (up to 16 alphanumeric characters) and press the DISP/ENTER key. For the procedures related to entering character strings, see "Entering Character" on page 3-22.

Confirming operation

To confirm the new settings, press the DISP/ENTER key.

To cancel the new settings, press the ESC key. A window appears for you to confirm the cancellation. Select [Yes] using the arrow keys and press the DISP/ENTER key.

7.6 Setting Groups

Trend, digital, and bar graph screens are displayed in groups. Channels can be assigned to each group and the group name can be registered.

- Number of groups: 4
- Number of channels: Up to 6 channels/group
- As for setting the channels to display the trend, see section 8.10.

Procedure

- These procedures are carried out in the setting mode.
- Use the arrow keys to move the cursor (blue) to the appropriate parameter. (The parameters that cannot be changed are grayed.)
- The possible selections are displayed at the bottom of the screen. Select using the soft keys.
- The parameter boxes that are changed are displayed in yellow. By confirming the new settings, they change back to white.

Press .

Press the soft key .

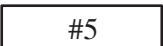
Press the soft key .

To display the setting screen press the soft key .

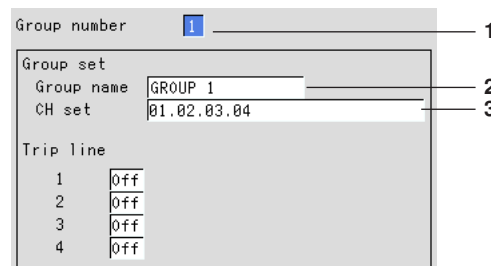

The numbers in front of the operating procedure shown below correspond to the numbers in the above figure.

1. Group number
Select the group number (1 to 4).
2. Group name
Pressing the [Input] soft key displays a window used to enter the group name. Enter the group name (up to 16 alphanumeric characters) and press the DISP/ENTER key. For the procedures related to entering character strings, see "Entering Characters" on page 3-22.
3. CH set
Assign measurement/computation channels to groups.
Enter the channel number according to the following rules using the same method as step 2.
 - Enter the channel number using two digits.
 - Separate each channel with a period.
 - Consecutive channels can be specified using a hyphen.Example: To set CH1, CH3, CH5 to CH8 to a particular group, "01.03.05- 08" is entered.

Note

- The channels are displayed in the order they are specified on the trend, digital, bar graph screens.
- One channel can be assigned to multiple groups.
- A channel cannot be assigned twice in the same group.

Confirming operation

To confirm the new settings, press the DISP/ENTER key.

To cancel the new settings, press the ESC key. A window appears for you to confirm the cancellation. Select [Yes] using the arrow keys and press the DISP/ENTER key.

Explanation**Initial settings of the groups**

Group Name

Group 1: GROUP 1

Group 2: GROUP 2

Group 3: GROUP 3

Group 4: GROUP 4

The initial value varies depending on the number of installed channels.

Group Number	DX102L	DX104L	DX106L	DX112L
1	01.02	01.02.03.04	01.02.03.04.05.06	01.02.03.04.05.06
2	01.02	01.02.03.04	01.02.03.04.05.06	07.08.09.10.11.12
3	01.02	01.02.03.04	01.02.03.04.05.06	01.02.03.04.05.06
4	01.02	01.02.03.04	01.02.03.04.05.06	07.08.09.10.11.12

7.7 Setting the Trip Line (Trend)

A line to indicate a particular value of interest (trip line) can be displayed on the trend display.

- The maximum number of trip lines that can be displayed in one group is four.
- The position of the trip line is specified as a percentage of the display span.
- You can specify the thickness of the trip lines. See section 7.13.

Procedure

- These procedures are carried out in the setting mode.
- Use the arrow keys to move the cursor (blue) to the appropriate parameter. (The parameters that cannot be changed are grayed.)
- The possible selections are displayed at the bottom of the screen. Select using the soft keys.
- The parameter boxes that are changed are displayed in yellow. By confirming the new settings, they change back to white.

Press .

Press the soft key .

Press the soft key .

To display the setting screen press the soft key .

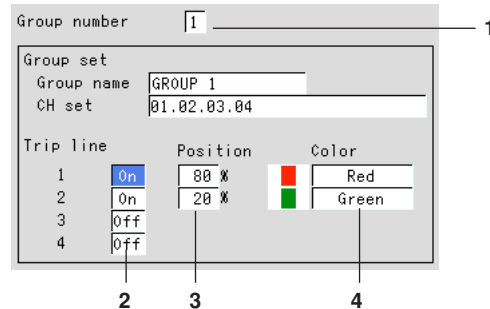

Trip line	On/Off	Position	Color
1	On	80 %	Red
2	On	20 %	Green
3	Off		
4	Off		

The numbers in front of the operating procedure shown below correspond to the numbers in the above figure.

1. Group number
Select the group number (1 to 4).
2. On/Off
Move the cursor to the desired trip line and press the [On] soft key.
[On]: Use the trip line. The [Position] and [Color] boxes appear.
[Off]: Not use the trip line.
3. Position (display position)
Pressing the [Input] soft key displays a window used to enter the display position. Enter a numerical value (1 to 100) and press the DISP/ENTER key.
For the procedures related to entering numerical values, see "Entering Numbers" on page 3-21.
4. Color
Select the color of the trip line from 16 colors.

Confirming operation

To confirm the new settings, press the DISP/ENTER key.

To cancel the new settings, press the ESC key. A window appears for you to confirm the cancellation. Select [Yes] using the arrow keys and press the DISP/ENTER key.

Explanation

Initial colors of the trip lines

Trip line No.1: Red

Trip line No.2: Green

Trip line No.3: Blue

Trip line No.4: Yellow

Available colors for the trip line

Red, green, blue, blue violet, brown, orange, yellow-green, light blue, violet, gray, limes, cyan, dark blue, yellow, silver, and purple

7.8 Setting the Channel Display Colors (Trend, Bar Graph)

Procedure

- These procedures are carried out in the setting mode.
- Use the arrow keys to move the cursor (blue) to the appropriate parameter. (The parameters that cannot be changed are grayed.)
- The possible selections are displayed at the bottom of the screen. Select using the soft keys.
- The parameter boxes that are changed are displayed in yellow. By confirming the new settings, they change back to white.

Press .

Press the soft key .

Press the soft key .

Setting on a measurement channel

To display the setting screen press the soft key .

Setting on a computation channel (option)

To display the setting screen press the soft key .

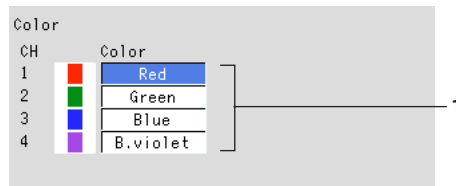

The numbers in front of the operating procedure shown below correspond to the numbers in the above figure.

1. Channel display color
Move the cursor to the desired channel and set the channel display color (select from 16 colors).

Confirming operation

To confirm the new settings, press the DISP/ENTER key.

To cancel the new settings, press the ESC key. A window appears for you to confirm the cancellation. Select [Yes] using the arrow keys and press the DISP/ENTER key.

Explanation

Initial Settings of Channel Display Color

Channel 1: Red, Channel 2: Green, Channel 3: Blue, Channel 4: Blue violet, Channel 5: Brown, Channel 6: Orange, Channel 7: Yellow-green, Channel 8: Light blue, Channel 9: violet, Channel 10: Gray, Channel 11: Lime, Channel 12: Cyan

Available colors for the channels

Red, green, blue, blue violet, brown, orange, yellow-green, light blue, violet, gray, limes, cyan, dark blue, yellow, silver, and purple

7.9 Using Zone Displays (Trend)

By using zones, the waveforms of each channel can be displayed in their own zones. Because the waveforms do not overlap, they are easier to view.

Procedure

- These procedures are carried out in the setting mode.
- Use the arrow keys to move the cursor (blue) to the appropriate parameter. (The parameters that cannot be changed are grayed.)
- The possible selections are displayed at the bottom of the screen. Select using the soft keys.
- The parameter boxes that are changed are displayed in yellow. By confirming the new settings, they change back to white.

Press .

Press the soft key .

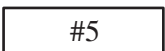
Press the soft key .

Setting on a measurement channel

To display the setting screen press the soft key .

Setting on a computation channel (option)

To display the setting screen press the soft key .

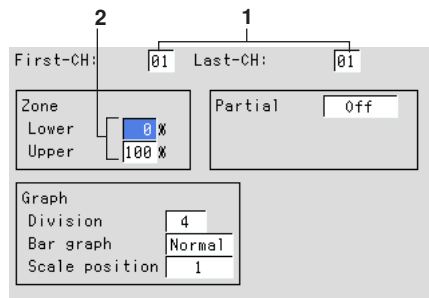

The numbers in front of the operating procedure shown below correspond to the numbers in the above figure.

1. First channel and last channel
Select the desired channels. (For the channels set here, [Graph] and [Partial] are also simultaneously set.)
2. Zone upper limit and lower limit
The waveform is displayed between the [Upper] and [Lower] limits. The [Upper] and [Lower] limits are set as percentages of the display span.
[Lower]: 0 to 95%
[Upper]: 5 to 100%
Pressing the [Input] soft key displays a window used to enter a numerical value. Enter a value and press the DISP/ENTER key.
For the procedures related to entering numerical values, see "Entering Numbers" on page 3-21.

7.9 Using Zone Displays (Trend)

Note

- [Lower] must be a smaller value than [Upper].
 - The width of the zone (upper limit – lower limit) must be greater than or equal to 5%.
-

Confirming operation

To confirm the new settings, press the DISP/ENTER key.

To cancel the new settings, press the ESC key. A window appears for you to confirm the cancellation. Select [Yes] using the arrow keys and press the DISP/ENTER key.

7.10 Setting the Scale Division, Bar Graph Base Position (Bar Graph), and Scale Position (Trend)

- The scale used on trend and bar graphs can be set.
- When the bar graph is displayed horizontally, the base position of the bar graph can be set on each channel by selecting either [Normal] or [Center].
[Normal]: The left edge or the right edge of the display span depending on which value is smaller.
[Center]: Position at 50% of the display span
- For the procedures to set the vertical or horizontal display, see section 7.13.
- The scale display position for each channel can be specified on the trend screen.

Procedure

- These procedures are carried out in the setting mode.
- Use the arrow keys to move the cursor (blue) to the appropriate parameter. (The parameters that cannot be changed are grayed.)
- The possible selections are displayed at the bottom of the screen. Select using the soft keys.
- The parameter boxes that are changed are displayed in yellow. By confirming the new settings, they change back to white.

Press .

Press the soft key .

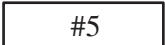
Press the soft key .

Setting on a measurement channel

To display the setting screen press the soft key .

Setting on a computation channel (option)

To display the setting screen press the soft key .

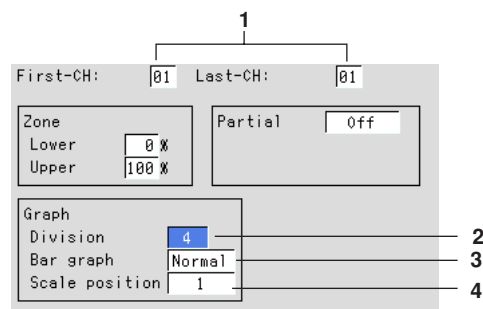

The numbers in front of the operating procedure shown below correspond to the numbers in the above figure.

1. First channel and last channel
Select the desired channels. (For the channels set here, [Zone] and [Partial] are also simultaneously set.)

7.10 Setting the Scale Division, Bar Graph Base Position (Bar Graph), and Scale Position (Trend)

Setting the number of divisions for the scale

2. Division

This is the number of scale divisions. The scale is equally divided and scale marks are displayed at the divided position. Select the number of divisions from [4] to [12] and [C10].

[C10]: The scale is equally divided into 10 sections by main scale marks, and scale values are indicated at 0, 30, 50, 70, and 100% positions.

For bar graph display: Only the main scale marks are displayed.

For trend display: See "Explanation."

Setting the bar graph's base position

3. Bar graph (base position of the bar graph)

Select normal or center.

Note

When the bar graph is displayed vertically (see section 7.13), the base position is fixed to [Normal] (the bottom of the bar graph is the base position).

Setting the scale position on the trend screen

4. Scale position

The [Scale position] is used to set the scale display position for each channel when the scale display is turned [On] (see section 4.3) on the trend screen.

Select the position from [1] to [6]. Select [Off] for channels without scale.

Note

- The scale for the channels that are assigned to the group in the trend screen are displayed.
 - The larger the number of scales to be displayed, less amount of area there is to display the waveform.
-

Confirming operation

To confirm the new settings, press the DISP/ENTER key.

To cancel the new settings, press the ESC key. A window appears for you to confirm the cancellation. Select [Yes] using the arrow keys and press the DISP/ENTER key.

Explanation

Scale Specifications

Scale display position

On the trend screen, the scale for the channels that are assigned to groups can be displayed in 6 different positions (see the figure below).

- **During trend vertical display (see page 7-19 for horizontal display)**

The scale display position is 1, 2, 3, 4, 5, and 6 from the top.

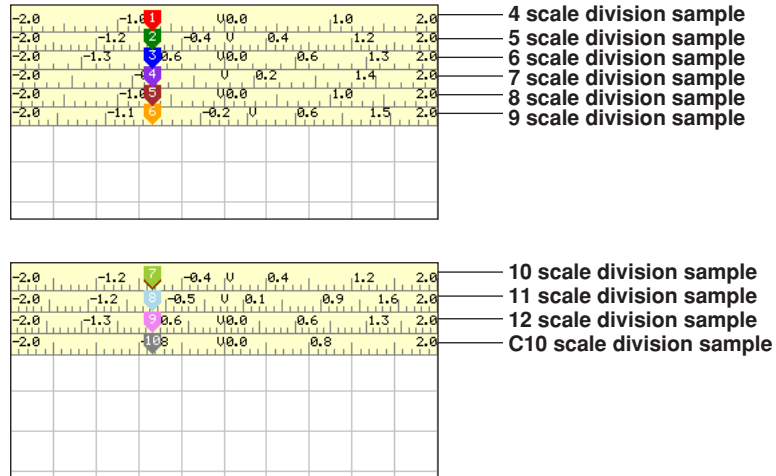

The scale is divided into 4 to 12 sections as shown in the figure above.

- If the scales for two or more channels are specified to the same position, the scale for the channel that was assigned first to the group is displayed.

Example 1: When the channels were assigned to a group in the following order:

[03.02.01.05], and the scale display positions for channels 3, 2, 1, and 5 are all set to [1]

The scale for channel 3 is displayed at position 1.

- Vacant positions in between scale assigned positions are void. The scales are displayed close together from the display position 1.

Example 2: When the channels were assigned to a group in the following order:

[01.02.03.05], and the scale display position for channels 1, 2, 3, and 5 are set to positions 1, 3, 5, and 6, respectively

The scales for the channels are actually displayed at positions 1, 2, 3, and 4, respectively.

- If the scale display position is set to [Off], the scale is not displayed.

- **During trend horizontal display**

The scale display position is 6, 5, 4, 3, 2, and 1 from the left.

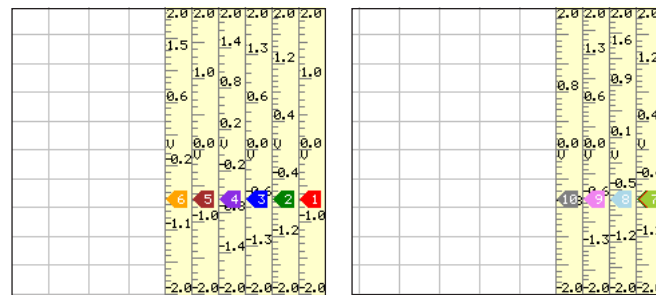

7.10 Setting the Scale Division, Bar Graph Base Position (Bar Graph), and Scale Position (Trend)

Scale marks

The scale can be divided into 4 to 12 sections using the main scale marks. When the scale is divided into 4 or 5 section, the area between the main scale marks is divided further into 10 sections using small and medium marks. When the scale is divided into 6 to 12 sections, the area between the main scale marks is divided further into 5 sections using small marks.

However, small marks are not displayed for the following cases:

- When the measurement/computation range resolution is smaller than the total number of sections created by small marks.
- When zone display is used
- When partial expanded display is used

Scale values

The scale values are displayed at all main scale marks when the scale is divided into 4 to 7 (4 to 6 for trend vertical display) sections using the main scale marks. When the scale is divided into 8 to 12 (7 to 12 for trend vertical display) sections, the scale values are displayed at every other main scale mark.

In addition, the upper or lower limit of the scale is displayed at the end of the scale.

Rule 1 Up to 3 digits excluding the minus sign can be displayed for the scale values.

Rule 2 If the integer section of either value at the end of the scale is less than or equal to one digit, the value is displayed as $\square.\square$ or $0.\square$.

Example 1: If the scale is set to -0.05 to 0.5 , the scale display for the upper and lower limits is -0.0 to 0.5 .

Example 2: If the scale is set to -0.005 to 0.05 , the scale display for the upper and lower limits are -0.0 to 0.0 .

Rule 3 If the integer section of either value at the end of the scale is two digits or three digits, the value is displayed with the decimal fraction is discarded.

Example 3: If the scale is set to 0.1 to 100.0 , the scale display for the upper and lower limits is 0 to 100 .

Rule 4 If the integer section of either value at the end of the scale is greater than or equal to four digits, a three-digit mantissa and exponent are displayed ($\times 10$ or $\times 10^2$, for example).

Example 4: If the scale is set to 10 to 2000 , the scale display for the upper and lower limits are 0 to 200×10 .

The number of digits of the scale values can be increased by one digit within Rule 1. For the procedure, see section 7.13.

Consider the case when the scale marks are between 49.0 and 51.0 using [C10]

division. Normally the decimals of the scale values are truncated according to Rule 3.

However, if the number of digits is increased by one, the values are displayed as follows:

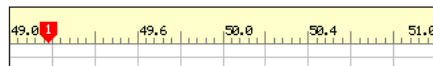

7.10 Setting the Scale Division, Bar Graph Base Position (Bar Graph), and Scale Position (Trend)

Unit

The unit is displayed near the center of the scale. When the partial expanded display is used, the position will be shifted.

When the trend is displayed horizontally, the number of characters that can be displayed is up to 3. If the [Scale digit] is set to [Fine], up to 4 characters can be displayed.

Bar base position

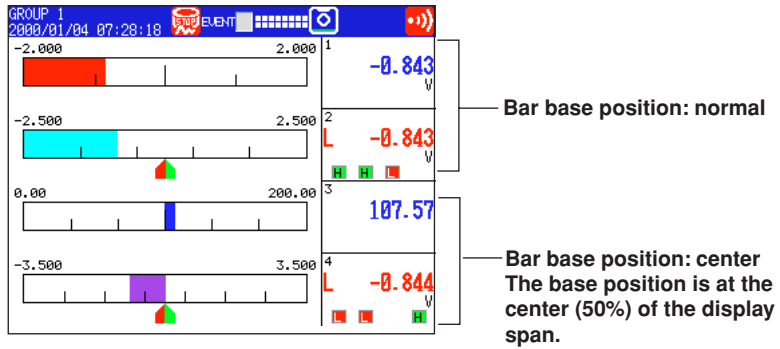

7.11 Using Partial Expanded Display (Trend)

By compressing a section of the display scale of the measured/computed data, the remaining section of the display is expanded. For detail, see section 1.3.

To use the partial expanded display, first, set the partial expanded display to [Use] in the basic setting mode. This will display a partial expanded display setting box in the setting mode (see section 7.12).

Procedure

- These procedures are carried out in the setting mode.
- Use the arrow keys to move the cursor (blue) to the appropriate parameter. (The parameters that cannot be changed are grayed.)
- The possible selections are displayed at the bottom of the screen. Select using the soft keys.
- The parameter boxes that are changed are displayed in yellow. By confirming the new settings, they change back to white.

Press .

Press the soft key .

Press the soft key .

Setting on a measurement channel

To display the setting screen press the soft key .

Setting on a computation channel (option)

To display the setting screen press the soft key .

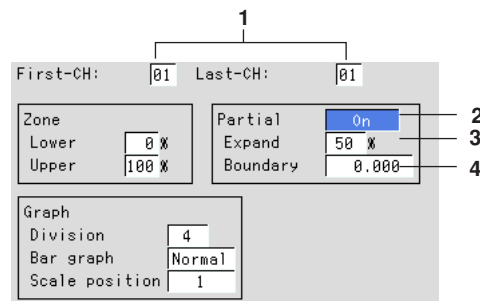

The numbers in front of the operating procedure shown below correspond to the numbers in the above figure.

1. First channel and last channel
Select the desired channels. (For the channels set here, [Zone] and [Graph] are also simultaneously set.)
2. On/Off
When [On] is selected, the [Expand] and [Boundary] boxes are displayed.
[On]: Use the partial expanded display.
[Off]: Not use the partial expanded display.
3. Expand (Boundary displacement position)
Set the position to which a particular value (the boundary, see step 4) in the display span is to be moved as a percentage of the display span.
Pressing the [Input] soft key displays a window used to enter a numerical value. Enter the position and press the DISP/ENTER key. For the procedures related to entering numerical values, see "Entering Numbers" on page 3-21.
The range for the position: 1 to 99

4. Boundary

This is a value within the display span. By moving the value within the display span to another position (see step 3), the area on either side of the boundary is expanded or compressed.

Enter the boundary using the same method as step 3.

The range for the boundary:

The minimum value of the span +1 digit to the maximum value of the span –1 digit (when the range is not set to “scaling”)

The minimum value of the scale +1 digit to the maximum value of the scale –1 digit (when the range is set to “scaling”).

Confirming operation

To confirm the new settings, press the DISP/ENTER key.

To cancel the new settings, press the ESC key. A window appears for you to confirm the cancellation. Select [Yes] using the arrow keys and press the DISP/ENTER key.

Note

- The partial expanded display is turned OFF for all channels if the partial expanded display setting (use/not use) in the basic setting mode is changed and stored.
 - When the range setting of the channel is set to [Skip] or when the span width is less than or equal to 1 digit, the partial expanded display cannot be specified. (The box is grayed in this case.)
-

7.12 Setting Whether or Not to Use the Partial Expanded Display (Basic Setting Mode)

Set whether or not to use the partial expanded display.

- The initial setting is [Not] (disabled).
- The display specifications of the partial expanded display are set in the setting mode.

Procedure

- These procedures are carried out in the basic setting mode.
- Use the arrow keys to move the cursor (blue) to the appropriate parameter.
- The possible selections are displayed at the bottom of the screen. Select using the soft keys.
- The parameter boxes that are changed are displayed in yellow. By confirming the new settings, they change back to white.

Press .

Press  for 3 seconds. The menu screen for the basic setting mode appears.

Press the soft key .

To display the setting screen press the soft key .

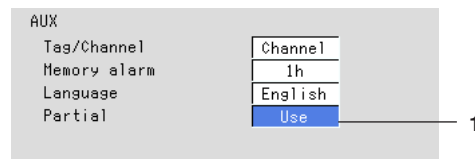

The numbers in front of the operating procedure shown below correspond to the numbers in the above figure.

1. Partial
Select [Use] or [Not].
[Use]: Partial expanded display can be set in the setting mode.
[Not]: Partial expanded display cannot be set.

Confirming operation

To confirm the new settings, press the DISP/ENTER key.

To cancel the new settings, press the ESC key. A window appears for you to confirm the cancellation. Select [Yes] using the arrow keys and press the DISP/ENTER key.

7.13 Setting the Display Direction, Background Color, Waveform Line Width, Trip Line Width, Grid, Scroll Time, and Scale digit

- The display direction of the trend and bar graph can be set to horizontal or vertical.
- The background color used in the trend, digital, bar graph, and information screens can be set to white or black (common to all screens).
- The line width of the waveform can be selected as 1, 2, or 3 dots.
- The line width of the trip line can be selected as 1, 2, or 3 dots.
- The grid lines can be displayed on the trend's waveform display area by dividing the display span into 4 to 12 sections.
- The interval at which the displayed group is automatically switched on the trend, digital, and bar graph screens can be specified. The displayed group rotates from group 1 to group 4.
- You can increase the number of digits of the scale values by one digit on the trend display.

Procedure

- These procedures are carried out in the setting mode.
- Use the arrow keys to move the cursor (blue) to the appropriate parameter. (The parameters that cannot be changed are grayed.)
- The possible selections are displayed at the bottom of the screen. Select using the soft keys.
- The parameter boxes that are changed are displayed in yellow. By confirming the new settings, they change back to white.

Press .

Press the soft key .

Press the soft key .

To display the setting screen press the soft key .

View		
Direction		
Trend	Vertical	1
Bargraph	Horizontal	2
Background	White	3
Trend line	2 dot	4
Trip line	2 dot	5
Grid	10 div	6
Scroll time	5s	7
Scale digit	Normal	8

The numbers in front of the operating procedure shown below correspond to the numbers in the above figure.

Set the display direction of the trend

1. Direction - Trend
Select [Horizontal], [Vertical], or [Horizon 2].

Set the display direction of the bar graph

2. Direction - Bar graph
Select [Horizontal] or [Vertical].

Set the background color

3. Background
Select white or black.

Note

The background color of the historical trend is opposite that of the trend display.

Setting the line width of the waveform

4. Trend line
Select the width of the waveform line as [1], [2], or [3] dots.

Setting the width of the trip line

5. Trip line
Select the width of the trip line as [1], [2], or [3] dots.

Setting the number of grids on the waveform display area

6. Grid
Select the number of grids from [4] to [12], or [Auto].
[Auto]: Display the same number of grids as the number of scale divisions of the first assigned channel of the group.

Setting the interval at which the displayed group is automatically switched

7. Scroll time
Select the interval from [5 s], [10 s], [20 s], [30 s], and [1 min].

Setting the number of displayed digits of the scale value

8. Scale digit
[Normal]: See the explanation given in “Scale values” in section 7.10.
[Fine]: The number of displayed digits of the scale value is increased by one.
See the explanation given in “Scale values” in section 7.10.

Confirming operation

To confirm the new settings, press the DISP/ENTER key.
To cancel the new settings, press the ESC key. A window appears for you to confirm the cancellation. Select [Yes] using the arrow keys and press the DISP/ENTER key.

Explanation

Grid on the waveform display area

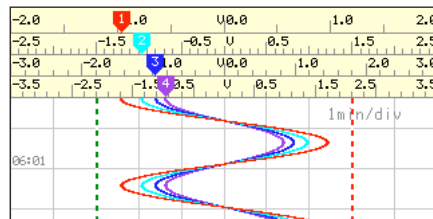

Grid(The number of grid is 10 in this example)

7.14 Setting the Brightness of the Screen and the Backlight Saver Function

- There are eight screen brightness settings which can be selected (1 to 8).
- The lifetime of the LCD backlight can be extended by automatically dimming the light when there has been no key operation for a certain amount of time. The screen will return to the original brightness with a key operation or an alarm occurrence. The screen saver is initially disabled.

Note

The degradation of the brightness and the discoloration of the screen (become yellowish) tend to progress faster as the brightness is set higher. Extended use at an unnecessary high setting should be avoided. It is also recommended that the backlight saver be used.

Procedure

- These procedures are carried out in the setting mode.
- Use the arrow keys to move the cursor (blue) to the appropriate parameter. (The parameters that cannot be changed are grayed.)
- The possible selections are displayed at the bottom of the screen. Select using the soft keys.
- The parameter boxes that are changed are displayed in yellow. By confirming the new settings, they change back to white.

Press .

Press the soft key .

Press the soft key .

To display the setting screen press the soft key .



The numbers in front of the operating procedure shown below correspond to the numbers in the above figure.

Setting the brightness of the screen

1. Brightness
Select from 1 to 8. A higher number corresponds to a brighter screen setting.

Setting the backlight saver

2. Saver
When [On] is selected, [Saver time] and [Restore] boxes are displayed.
3. Saver time
Select the time from 1 min, 2 min, 5 min, 10 min, 30 min, and 1 hour.
If the specified time elapses without any key operation, the LCD backlight is automatically dimmed.
4. Restore
Select [Key] or [Key + Alm] (Key + Alarm).
[Key]: The screen will return to the original brightness with a key operation.
[Key + Alm]: The screen will return to the original brightness with a key operation or an alarm occurrence.

7.14 Setting the Brightness of the Screen and the Backlight Saver Function

Confirming operation

To confirm the new settings, press the DISP/ENTER key.

To cancel the new settings, press the ESC key. A window appears for you to confirm the cancellation. Select [Yes] using the arrow keys and press the DISP/ENTER key.

8.1 Data Types to be Acquired and Saved

Data Types and File Names

Data type

The types and the contents of the data that are acquired are as follows. Beside those data listed below, the setup data (see section 9.1) and the screen image data (see section 9.6) can be saved to the external storage medium.

Type	Content
Display data	<ul style="list-style-type: none"> Waveform data that are used to display trends on the LCD screen. The maximum and minimum values from measured/computed data within the sampling intervals are held. A header string can be written into the display data file (a character string that is common to all data files). Alarm and message information is held. Data format: Binary format
Event data	<ul style="list-style-type: none"> The instantaneous values of the measured/computed data are acquired at the specified sampling interval. There is a mode in which the data acquisition is started when a trigger occurs or another mode in which the data acquisition is started when the START key is pressed. The header string can be written into the event data file (a character string that is common to all data files). Alarm and message information is held. Data format: Binary format
Manual sampled data	<ul style="list-style-type: none"> Every time a key that executes manual sampling is pressed, measured/computed data (instantaneous values) of all channels at that point are acquired. Up to 50 samples of data can be stored in the internal memory. The header string can be written into the manual sampled data file (a character string that is common to all data files). Data format: ASCII format
TLOG data (option)	<ul style="list-style-type: none"> Data are added to the internal memory at the end of every interval period. Up to 400 data sets can be stored in the internal memory. The header string can be written into the TLOG data file (a character string that is common to all data files). Data format: Binary format
Report data (option)	<ul style="list-style-type: none"> Consists of hourly, daily, weekly, and monthly reports. Data are computed at intervals depending on the report type (one hour for hourly report, one day for daily report, etc). Data are added to the internal memory at the end of every interval period. Up to 40 reports can be stored in the internal memory. Each report file can contain up to 12 measured/computed channels of report data. The header string can be written into the report data file (a character string that is common to all data files). Data format: ASCII format

8.1 Data Types to be Acquired and Saved

File name

File names are automatically assigned (month/day/hour/minute of the first sampled data + sequence number. extension) for display data, event data, manual sampled data, TLOG data (option), and report data (option).

- Display data file: Mddhhmma.DDS
- Event data file: Mddhhmma.DEV
- Manual sampled data file: Mddhhmma.DMN
- TLOG data file: Mddhhmma.DTG
- Hourly report data file: Mddhhmma.DHR
- Daily report data file: Mddhhmma.DDR
- Weekly report data file: Mddhhmma.DWR
- Monthly report data file: Mddhhmma.DMR

where, M: month (1 to 9, X (10), Y (11), Z (12)), dd: date, hh: hour, mm: minute, a: sequence number

Note

The sequence number of the file name is normally set to 0. However, if the display data acquisition is started, stopped, and restarted within one minute, for example, then the file name of the two files will have sequence numbers 0 and 1 for the first and second files, respectively (The two files will have the same Mddhhmm (month/day/hour/minute) section).

8.2 Function to Acquire Display Data and Event Data

The display and event data are acquired by specifying the channels, sampling interval, file size, and other information.

Specifying the data to be acquired

Display data and event data

Specify the type of data to be acquired depending on the application. Several examples are shown below. Please use them as references.

Example 1: Continuously record the waveform data as in the conventional chart-type recorders.

Select "display data only."

Example 2: Continuously record the waveform data and when an alarm occurs, record detailed data around the alarm incident.

Select "display data and event data." For the event data, select "Trigger" or "Rotate" for the mode. Specify the trigger used to start the event data acquisition and the time period during which to acquire the data (event data file size).

Example 3: Continuously record detailed data.

Select "even data only." Select "Free" for the mode.

Example 4: Recording is not necessary under normal circumstances. Only record detailed data around the alarm incident.

Select "event data only." Select "Trigger" or "Rotate" for the mode. Specify the trigger used to start the event data acquisition and the time period during which to acquire the data.

Data type

Select "display data only," "display data and event data," or "event data only."

Channels to be stored

Select the channels to be acquired from measurement and computation channels.

Data acquisition

Display data

This operation is performed when the type of data acquired is set to "display data only," or "display data and event data."

Data acquisition starts when the START key is pressed and stops when the STOP key is pressed.

The display data are overwritten when the display data storage area in the internal memory becomes full, or the number of files* exceeds 16.

* The number of display data files

During manual save, a file is created for each data write operation (a set of start and stop operations). During auto save, a file is created every auto save interval and at every specified date/time.

Note

- The display data in the internal memory can be confirmed with the memory summary. ⇒ "Section 4.5"
- When a power disruption occurs the file is closed.

8.2 Function to Acquire Display Data and Event Data

Event data

This operation is performed when the type of data acquired is set to “event data only,” or “display data and event data.” There are three modes in data acquisition, [Free], [Trigger], and [Rotate]. [Free] mode can be set when acquiring the event data only.

Mode	Description
Free	Data acquisition is started by pressing the START key. The operation is stopped by pressing the STOP key. When the storage area of the internal memory becomes full, or the number of files* in the internal memory exceeds 16, it is overwritten. * The number of display data files During manual save, a file is created for each data write operation (start and stop operations). During auto save, a file is created every specified interval (data length, see section 8.11) and at every specified date/time.

Trigger
When the internal memory is not divided into blocks:
 One event data file is created in the internal memory. Press the START key to enter the trigger wait state. After the trigger is activated, data are acquired for the specified time (data length, see section 8.11) and the operation is stopped. At this point, the acquisition does not start even if the trigger is activated.

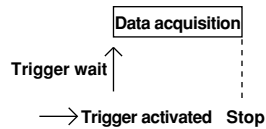

When the internal memory is divided into blocks:
 An event data file each in the block is created. Press the START key to enter the trigger wait state. After the trigger is activated, data are acquired for the specified time (data length, see section 8.11) and the operation is stopped. When the trigger is activated again, data are acquired and stored to the next block. When all blocks are full, no more acquisition takes place.

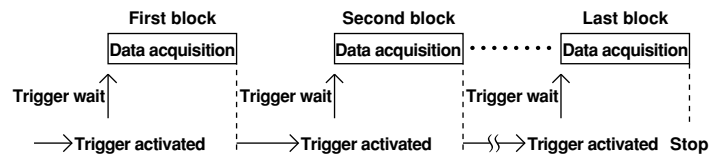

Mode	Description
Rotate	<p>When the internal memory is not divided into blocks: One event data file is created in the internal memory. Press the START key to enter the trigger wait state. After the trigger is activated, data are acquired for the specified time (data length, see section 8.11) and the operation is stopped. Data are overwritten when the trigger is activated again. Every time the trigger is activated during the trigger wait state, data are overwritten. Press the STOP key to terminate data acquisition.</p>

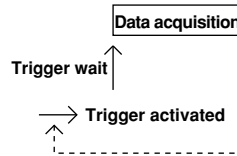

When the internal memory is divided into blocks:
 An event data file each in the blocks is created.
 Press the START key to enter the trigger wait state.
 After the trigger is activated, data are acquired for the specified time (data length, see section 8.11) and the operation is stopped. When the trigger is activated again, data are acquired and stored to the next block. When all blocks are full and the trigger is activated, data are overwritten to the first block. Every time the trigger is activated during the trigger wait state, data are overwritten to the next block. Press the STOP key to terminate data acquisition.

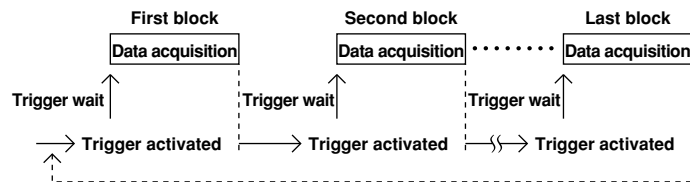

Note

- The event data in the internal memory can be confirmed with the memory summary. ⇒ “Section 4.5”
- When a power failure occurs, the event data file in the internal memory is closed as one file.

Pretrigger for the event data

Pretrigger is applied to the event data with [Trigger] or [Rotate] modes.

You can have event data before the trigger point be stored.

It is specified in terms of a percentage of the data length (0, 5, 25, 50, 75, 95, 100%). If 0% is selected, all data are after the trigger point. The initial setting is 0%.

Trigger type for the event data

When [Trigger] or [Rotate] is selected, the trigger type is selected by turning each type of trigger ON/OFF. The triggers operate in an OR fashion: the trigger is activated when any of the conditions that are turned ON are satisfied.

Type	Description
Key trigger	The trigger condition is satisfied when the FUNC - [Trigger] soft key or the USER key (only when the “trigger” function is assigned to the USER key) is pressed.
External trigger	The trigger condition is satisfied when the external contact specified by Remote Control function is turned ON. See section 10.9.
Alarm trigger	The trigger condition is satisfied when any of the alarms occur.

8.2 Function to Acquire Display Data and Event Data

Number of data points that can be acquired and sampling length (the maximum auto save interval for display data, the maximum data length for event data)

This section describes the number of data points of the display data/event data that can be acquired and the sampling length. Use the information when determining the amount of time it takes for the internal memory to become full or when deciding the channels to be acquired or the sampling interval.

The possible range of menus of the auto save interval of display data and the data length of event data is displayed in the soft keys based on the information described here.

Data format

The display data have minimum and maximum values for each sampling interval. Event data consists of instantaneous values.

The number of data bytes per channel is shown in the following table.

Data Type	Measurement Channel	Computation Channel
Display data	4 bytes/channel	8 bytes/channel
Event data	2 bytes/channel	4 bytes/channel

Example

Data format when the data of measurement channels 1 to 4 and a computation channel 31 are acquired.

Display data

1st scan									
CH1	CH1	CH2	CH2	CH3	CH3	CH4	CH4	CH31	CH31
min	max	min	max	min	max	min	max	min	max
2nd scan									
CH1	CH1	CH2	CH2	CH3	CH3	CH4	CH4	CH31	CH31
min	max	min	max	min	max	min	max	min	max
to									
nth scan									
CH1	CH1	CH2	CH2	CH3	CH3	CH4	CH4	CH31	CH31
min	max	min	max	min	max	min	max	min	max

2 bytes (binary data)

Event data

1st scan				
CH1	CH2	CH3	CH4	CH31
2nd scan				
CH1	CH2	CH3	CH4	CH31
to				
nth scan				
CH1	CH2	CH3	CH4	CH31

2 bytes (binary data)

Internal memory capacity

The capacity of the internal memory that is used for data storage is 1.2 MB. The internal memory is allocated depending on the acquired data as follows.

Data being acquired	Internal Memory Capacity
Display data only	1.2 MB
Display data and event data	Display data: 0.9 MB Event data: 0.3 MB
Event data only	1.2 MB

Maximum number of data points per channel that can be acquired

The following table shows the maximum number of data points per channel that can be acquired.

Data being acquired	Maximum number of data points per channel
Display data only	1,200,000 bytes/(number of measurement channels × 4 + number of computation channels × 8) Except, the maximum number of data points is 100,000
Display data and event data	<ul style="list-style-type: none"> Display data 900,000 bytes/(number of measurement channels × 4 + number of computation channels × 8) Except, the maximum number of data points is 75,000 Event data 300,000 bytes/(number of measurement channels × 2 + number of computation channels × 4) Except, the maximum number of data points is 30,000
Event data only	1,200,000 bytes/(number of measurement channels × 2 + number of computation channels × 4) Except, the maximum number of data points is 120,000

Sampling length

The sampling length can be derived from the following equation.

Sampling length = the maximum number of data points per channel × sampling interval

Calculation example

• **Display data only**

Measurement channel: 2, computation channel: none

Data	Maximum number of data points and sampling length
Display data	Maximum number of data points = $1,200,000 / (2 \text{ CH} \times 4 \text{ bytes} + 0 \times 8 \text{ bytes}) = 150,000$. However, since 100,000 data points is the limit, Maximum number of data points = 100,000 When the display update rate is 30 min/div (60 s sampling interval) Sampling length = 100,000 data points × 60 s = 6,000,000 s (approx. 69 days)

Measurement channel: 12, computation channel: 6

Data	Maximum number of data points and sampling length
Display data	Maximum number of data points = $1,200,000 / (12 \text{ CH} \times 4 \text{ bytes} + 6 \times 8 \text{ bytes}) = 12,500$ When the display update rate is 30 min/div (60 s sampling interval) Sampling length = 12,500 data points × 60 s = 750,000 s (approx. 8 days)

• **Event data only**

Measurement channel: 2, computation channel: None

Data	Maximum number of data points and sampling length
Display data	Maximum number of data points = $1,200,000 / (2 \text{ CH} \times 2 \text{ bytes} + 0 \times 4 \text{ bytes}) = 300,000$ However, since 120,000 data points is the limit, Maximum number of data points = 120,000 When the event data sampling interval is 1 s Sampling length = 120,000 data points × 1 s = 120,000 s (approx. 33 hours)

Measurement channel: 12, computation channel: 6

Data	Maximum number of data points and sampling length
Event data	Maximum number of data points = $1,200,000 / (12 \text{ CH} \times 2 \text{ bytes} + 6 \times 4 \text{ bytes}) = 25,000$ When the event data sampling interval is 1 s Sampling length = 25,000 data points × 1 s = 25,000 s (approx. 7 hours)

8.2 Function to Acquire Display Data and Event Data

- **Display data and event data**

Measurement channel: 2, computation channel: none

Data	Maximum number of data points and sampling length
Display data	Maximum number of data points = $900,000 / (2 \text{ CH} \times 4 \text{ bytes} + 0 \times 8 \text{ bytes}) = 112,500$ However, since 75,000 data points is the limit, Maximum number of data points = 75,000 When the display update rate is 30 min/div (60 s sampling interval) Sampling length = 75,000 data points \times 60 s = 4,500,000 s (approx. 52 days)
Event data	Maximum number of data points = $300,000 / (2 \text{ CH} \times 2 \text{ bytes} + 0 \times 4 \text{ bytes}) = 75,000$ However, since 30,000 data points is the limit, Maximum number of data points = 30,000 data points When the event data sampling interval is 1 s Sampling length = 30,000 data points \times 1 s = 30,000 s (approx. 8 hours)

Measurement channel: 12, computation channel: 6

Data	Maximum number of data points and sampling length
Display data	Maximum number of data points = $900,000 / (12 \text{ CH} \times 4 \text{ bytes} + 6 \times 8 \text{ bytes}) = 9,375$ When the display update rate is 30 min/div (60 s sampling interval) Sampling length = 9,375 data points \times 60 s = 562,500 s (approx. 6.5 days)
Event data	Maximum number of data points = $300,000 / (12 \text{ CH} \times 2 \text{ bytes} + 6 \times 4 \text{ bytes}) = 6,250$ When the event data sampling interval is 1 s Sampling length = 6,250 data points \times 1 s = 6,250 s (approx. 1.7 hours)

8.3 Function to Acquire Other Data

Manual sampled data

- When the manual sample key is pressed, the instantaneous values of all channels (excluding the measurement channels that are set to [Skip] and the computation channels that are turned Off) are acquired.
- Up to 50 data sets can be stored in the internal memory. When this number is exceeded, data are overwritten from the oldest data.

Note

The number of manual sampled data in the internal memory can be confirmed with the memory summary. ⇒ "Section 4.5"

TLOG data (option)

- TLOG data are acquired at each time interval set by timers.
- Up to 400 data sets can be stored in the internal memory. When this number is exceeded, data are overwritten from the oldest data.

Note

- Up to 16 TLOG files (number of start and stop) can be stored to the internal memory. When the number of files in the internal memory exceeds 16, TLOG data are overwritten even if the number of data sets is less than 400.
 - The number of TLOG data sets in the internal memory can be confirmed with the memory summary. ⇒ "Section 4.5"
-

Report data (option)

- Report data are acquired at each time interval (one hour for hourly report, one day for daily report, etc).
- Up to 40 data sets can be stored in the internal memory. When this number is exceeded, data are overwritten from the oldest data.
For "hourly only", this constitutes 40 minutes of report data. For "daily+monthly", this constitutes 39 daily reports and one monthly report or 38 daily reports and two monthly reports.

Note

The number of report data sets in the internal memory can be confirmed with the memory summary. ⇒ "Section 4.5"

8.4 Function that Saves the Data in the Internal Memory to the External Storage Medium

There are two methods in which the data are saved to the external storage medium, manual save and auto save.

Manual Save

The external storage medium is inserted into the drive only when storing the data residing in the internal memory.

When saving the data residing in the internal memory to the external storage medium, insert the storage medium into the drive and close the front cover. The storage medium in the drive is detected, and you can save the data residing in the internal memory to the storage medium. When the save operation is finished, remove the storage medium from the drive. Repeat the same procedure the next time the data is to be saved.

You can specify whether to save the entire data in the memory or only the data that have not been saved to the storage medium beforehand.

Auto Save

The external storage medium is placed in the drive at all times. Data saving to the external storage medium is done automatically.

Displayed data

The display data in the internal memory is saved to the external storage medium at the specified interval (auto save interval, see section 8.8) or the specified date and time (see section 8.12).

The down arrows (↓) in the example below indicate the times at which the display data or event data (only during "free" mode) in the internal memory is closed as a single file.

Example 1 Auto save interval: 1 day

Date and time to save data: Not specified



Example 2 Auto save interval: 1 day

Date and time to save data: 0:00 everyday

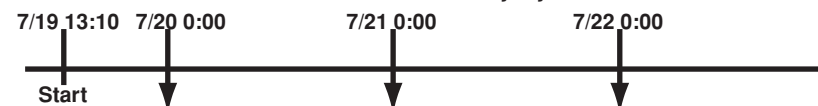

Example 3 Auto save interval: 12 hours

Date and time to save data: 0:00 everyday



Example 4 Auto save interval: 2 days

Date and time to save data: 0:00 everyday

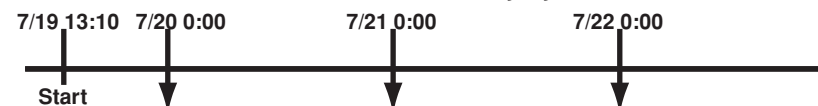

Event data

• During the free mode

The event data in the internal memory is saved to the external storage medium at the specified interval (data length, see section 8.11) or the specified date and time (see section 8.12).

8.4 Function that Saves the Data in the Internal Memory to the External Storage Medium

- **During trigger or rotate mode**

After acquiring the data to the internal memory over the specified period (data length, see section 8.11), the event data in the internal memory are saved to the external storage medium.

The following figure shows the operation when the acquisition area in the internal memory is divided using the trigger mode.

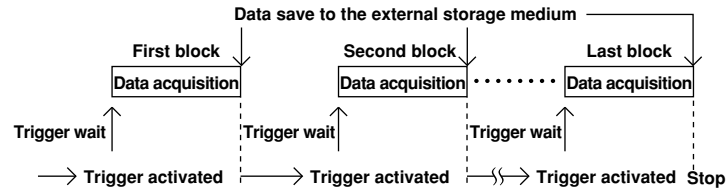

Manual sampled data

The first time manual sample is executed, a manual sampled data file is created on the external storage medium. The data are appended to this file for each successive manual sample operation.

Note

When auto save is selected and there is no medium in the drive at the time when manual sample is executed, all unsaved data are saved the first time when manual sample is executed, after the storage medium is reinserted into the drive.

TLOG data

The first time TLOG data is acquired, a TLOG data file is created on the external storage medium. The data are appended to this file at each time interval. When the number of TLOG data sets exceeds 400, a new file is created.

Note

When auto save is selected and there is no medium in the drive at the time when data are supposed to be saved, all unsaved data are saved the first time when the interval time expires after the storage medium is reinserted into the drive.

Report data

The first time report computation is executed, a report data file is created on the external storage medium. A file is created for each type of report such as hourly, daily, weekly, and monthly reports. The data are appended to this file at each time interval.

Note

When auto save is selected and there is no medium in the drive at the time when data are supposed to be saved, all unsaved data are saved the first time when the report data is created after the storage medium is reinserted into the drive.

- **Dividing report files**

The report files are divided at the following times.

- When data acquisition is stopped.
- For hourly reports
 - When the 0:00 report is created every day.
 - When the number of data sets in the file reaches 25.
- For daily reports
 - When the report for the first day of the month is created every month
 - When the number of data sets in the file reaches 32.

8.5 Acquiring Display Data

This operation is performed when the type of data acquired is set to [Display] or [E + D]. For setting the data acquisition method, see sections 8.10 and 8.11.

Procedure

Start data acquisition

To begin data acquisition, press the START key. The icon in the status display section will change accordingly.

Icon



Stop data acquisition

1. Press the STOP key. A confirmation window opens.

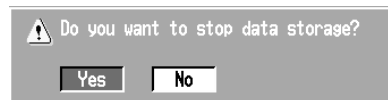

On models with the computation option, the confirmation window displays the following choices: [Mem + Math] (terminate acquisition and all computations), [Memory] (terminate acquisition), and [Cancel].

For models with the batch function (/BT1 option) that has the batch function enabled (see section 10.13), the batch information is also displayed.

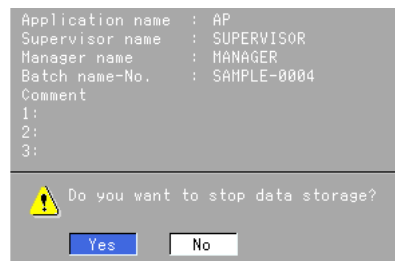

2. Select [Yes] ([Mem + Math] or [Memory] for models with the computation function) using the arrow keys and press the DISP/ENTER key to stop the data acquisition. The icon in the status display section changes to a stop icon.

Note

- When the memory area becomes full or the number of files exceeds 16, existing data will be overwritten starting with the oldest data.
- When a power disruption occurs the file is closed. When the power resumes, data are written to a new file.
- The START/STOP operation also starts/stops the report function.
- When the computation is stopped, it is started with the START key.

8.6 Acquiring Event Data

This operation is performed when the type of data acquired is set to [Event] or [E + D]. For setting the data acquisition method, see sections 8.10 and 8.11.

Procedure

During [Free] mode

Start data acquisition

To begin data acquisition, press the START key. The icon in the status display section will change accordingly.



Stop data acquisition

1. Press the STOP key. A confirmation window opens.

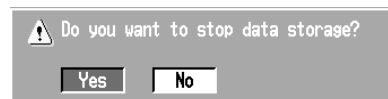

On models with the computation option, the confirmation window displays the following choices: [Mem + Math] (terminate acquisition and all computations), [Memory] (terminate acquisition), and [Cancel].

For models with the batch function (/BT1 option) that has the batch function enabled (see section 10.13), the batch information is also displayed.

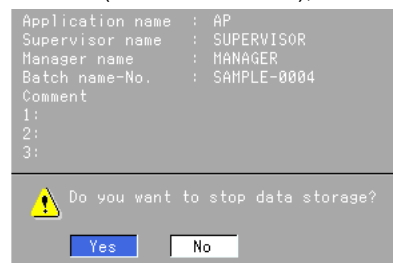

2. Select [Yes] ([Mem + Math] or [Memory] for models with the computation function) using the arrow keys and press the DISP/ENTER key to stop the data acquisition. The icon in the status display section changes to a stop icon.

Note

- When the memory area becomes full or the number of files exceeds 16, existing data will be overwritten starting with the oldest data.
- When a power disruption occurs the file is closed. When the power resumes, data are written to a new file.
- The START/STOP operation also starts/stops the report function.
- When the computation is stopped, it is started with the START key.

During [Trigger] mode or [Rotate] mode

Start data acquisition

1. Press the START key to enter the trigger wait state. The icon in the status display section will change accordingly. A bar indicating the pretrigger data in the status display section is displayed in orange.
2. When the trigger occurs, data acquisition starts.

Providing the key trigger that starts the data acquisition to the internal memory

This operation is carried out in the trigger wait state. For all other cases, this operation produces no effect. For details related to triggers other than the key trigger, see section sections 8.2 or 8.11.

- **Operation using the FUNC key**

1. Press the FUNC key to display the soft key menu.
2. Press the [Trigger] soft key to start the data acquisition of the event data to the internal memory.

- **Operation using the USER key**

This is an operation carried out only when the key trigger function is assigned to the USER key

1. Press the USER key to start the data acquisition of the event data to the internal memory.

Stop data acquisition

Data acquisition stops upon reaching the specified time (data length, see section 8.11). In the status display section, the block to which data were stored turns green. See section 4.2.

Note

During the [Trigger] mode, [Full] is displayed when data acquisition to all blocks is complete. When [Full] is displayed, event data are no longer acquired even if the trigger condition is met.

Terminate data acquisition with a key operation (in sync with the termination of the display data acquisition when acquiring the display data and the event data)

1. Press the STOP key. A confirmation window opens.
On models with the computation option, the confirmation window displays the following choices: [Mem + Math] (terminate acquisition and all computations), [Memory] (terminate acquisition), and [Cancel].
For models with the batch function (/BT1 option) that has the batch function enabled (see section 10.13), the batch information is also displayed.
2. Select [Yes] ([Mem + Math] or [Memory] for models with the computation function) using the arrow keys and press the DISP/ENTER key to stop the data acquisition. The icon in the status display section changes to a stop icon.

Note

- One file is created for one set of start and stop operations. The maximum number of files that can be stored in the internal memory is the specified number of blocks.
 - When a power disruption occurs the file is closed. When the power resumes, data are written to a new file.
 - The START/STOP operation also starts/stops the report function.
 - When the computation is stopped, it is started with the START key.
-

8.7 Saving the Data in the Internal Memory to the External Storage Medium

This operation saves the data in the internal memory to the external storage medium. Here, data refers to display data, event data, manual sampled data, TLOG data (option), and report data (option).

When using manual save

Procedure

The operation to save data in the internal memory to the external storage medium can be carried out when the storage medium is inserted into the drive.

1. Insert the storage medium into the drive and close the front cover. A window with a confirming message, [Do you want to save measured data?] appears.
2. Select [Yes] using the arrow keys and press the DISP/ENTER Key to save data. Select [No] using the arrow keys and press the DISP/ENTER key not to save data.

Note

- You can select whether to save all the data residing in the internal memory or only the data that have not been saved to the storage medium. See section 8.10.
- If saving to the storage medium is prevented with the key lock function and the key lock is enabled, data cannot be saved when the medium is inserted into the drive. Turn OFF the key lock before inserting the medium.
- It is possible that the data in the internal memory are overwritten before the data are stored to the external storage medium due to limitations such as the capacity of the internal memory. Refer to sections 8.2 and 8.3 and save the data to the external storage medium before they are overwritten. For the memory usage display of the internal memory, see section 4.2, "Using the Status Display Section."
- When the front cover is closed, the DX checks whether or not an external storage medium is inserted in the drive.
- Do not remove the storage medium while it is being accessed.

3. When the data save operation is finished, remove the storage medium from the drive.

When the external storage medium does not have enough space

Change the external storage medium to save the remaining data.

1. The message [Exchange media to continue the saving operation] will be displayed. Change the external storage medium and close the front cover. The message [Do you want to continue to save measured data?] will be displayed.
2. Selecting [Yes] and pressing the DISP/ENTER key saves the remaining data to the external storage medium. Selecting [No] and pressing the DISP/ENTER key does not save the remaining data.

Note

The data saving operation is interrupted in five minutes after the message [Exchange media to continue.....] was displayed. The message [Memory save to media was interrupted] will be displayed in this case.

The remaining data can be saved to the external storage medium by another manual save operation.

8.7 Saving the Data in the Internal Memory to the External Storage Medium

Explanation

Name of the directory to which to save the data

For the setting procedure of the directory to which to save the data, see section 8.9.

- Each time the storage medium is inserted into the drive and the data are saved, the sequence number of the directory name increments by one.

Example: When the specified directory name is "DATA0," the first set of data are saved to "DATA0.000" and the second set of data are saved to "DATA0.001."

- When the directory name is changed, the sequence number is reset to zero.
- When the data are divided and saved over multiple external storage media due to lack of space on the storage medium, the same directory name is used.
- If the specified directory already exists in the external storage medium, an error message is displayed and the operation terminates (data are not saved).

When using auto save

Data are automatically stored by leaving the external storage medium inserted in the drive. For the data storage operation, see section 8.4.

Procedure

Note

- Do not remove the external storage medium while it is being accessed.
 - For the memory usage display of the internal memory, see section 4.2.
 - To check the free space on the storage medium, see section 9.5.
 - For the name of the directory in which the data are saved, see section 8.9.
-

When the external storage medium does not have enough space

1. The message [Not enough free space on media] appears.
Change the external storage medium. The unsaved data are saved to the external storage medium at the time for the next "auto save" execution.

Note

Be aware that data in the internal memory will be overwritten if there is not enough free space on the external storage medium or if the storage medium is not inserted in the drive in the following cases:

- When the number of display data files exceeds 16. A file is created for each auto save interval (see section 8.8).
 - When the event data are acquired to the internal memory in the free run mode and the number of files exceeds 16. A file is created at specified acquisition periods (data length, see section 8.11).
-

Saving the data to the external storage medium using key operation during auto save mode

This operation applies when the data acquisition of the display data, or the data acquisition of event data in the free mode is in progress and the data storage to the storage medium is set to auto save. The display data or event data can be saved to the external storage medium at arbitrary times. The data acquisition to the internal memory continues even if this operation is carried out.

1. Press the FUNC key to display the soft key menu shown below.
 [Save Display]: When the type^{*1} of data acquired to the internal memory is display data or display data and event data.
 [Save Event]: When the type^{*1} of data acquired to the internal memory is event data and the free mode^{*1*2} is set.

*1 For the setting procedure, see section 8.11.

*2 The soft key is not displayed in the trigger or rotate mode.

2. Press the soft key to save the data in the internal memory to the external storage medium.

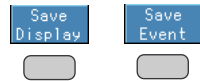

[Save Display]: The display data file is closed and saved to the external storage medium.

[Save Event]: The event data file is closed and saved to the external storage medium.

Explanation

Saving the data using key operation during auto save mode

The data are acquired to the internal memory for the specified period from the point at which the data were previously saved to the external storage medium using key operation. Then, the data in the internal memory are saved to the storage medium. This operation is repeated.

The following figure shows an example in which data are saved to the external storage medium at one-hour intervals.

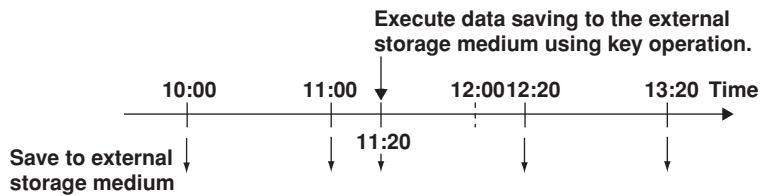

Saving the data to the storage medium using key operation

All data in the internal memory are saved to the external storage medium. This cannot be executed while data acquisition is in progress. For the operating procedure, see section 9.2.

Note

See section 9.7 or 9.8 to clear data in the internal memory.

8.8 Setting the Auto Save Interval for the Display Data

When the method to save the data residing in the memory to the external storage medium is [auto save], you set the auto save interval.

- The auto save interval is used in saving the display data.
- The display data residing in the internal memory is automatically saved to the external storage medium as a single file at each auto save interval.

Procedure

- These procedures are carried out in the setting mode.
- Use the arrow keys to move the cursor (blue) to the appropriate parameter. (The parameters that cannot be changed are grayed).
- The possible selections are displayed at the bottom of the screen. Select using the soft keys.
- The parameter boxes that are changed are displayed in yellow. By confirming the new settings, they change back to white.

Press .

To display the setting screen press the soft key .

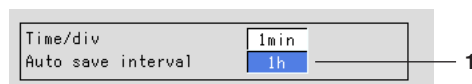

The numbers in front of the operating procedure shown below correspond to the numbers in the above figure.

1. Auto save interval
Displayed when [auto save] is selected. See section 8.8.
Select from the choices shown on the soft keys.

Confirming operation

To confirm the new settings, press the DISP/ENTER key.

To cancel the new settings, press the ESC key. A window appears for you to confirm the cancellation. Select [Yes] using the arrow keys and press the DISP/ENTER key.

Explanation**Choices for the auto save interval**

The maximum auto save interval varies depending on the display update rate (sampling interval is determined from the display update rate), the data type (display data only/ display data and event data), and the number of measurement and computation channels to be stored (see section 8.10). The available choices for the auto save interval are displayed on the soft key. See the table below.

Display update rate (DIV)	15 s*	30 s*	1 min	2 min	5 min	10 min	20 min	30 min	1 h	2 h	4 h	10 h
Sampling interval (s)	0.5	1	2	4	10	20	40	60	120	240	480	1200
Auto save interval (choices)	10 min	10 min	10 min	10 min	10 min	10 min						
	20 min	20 min	20 min	20 min	20 min	20 min						
	30 min	30 min	30 min	30 min	30 min	30 min						
	1 h	1 h	1 h	1 h	1 h	1 h	1 h	1 h	1 h			
	2 h	2 h	2 h	2 h	2 h	2 h	2 h	2 h	2 h	2 h		
	3 h	3 h	3 h	3 h	3 h	3 h	3 h	3 h	3 h	3 h		
	4 h	4 h	4 h	4 h	4 h	4 h	4 h	4 h	4 h	4 h	4 h	
	6 h	6 h	6 h	6 h	6 h	6 h	6 h	6 h	6 h	6 h	6 h	
	8 h	8 h	8 h	8 h	8 h	8 h	8 h	8 h	8 h	8 h	8 h	8 h
	12 h	12 h	12 h	12 h	12 h	12 h	12 h	12 h	12 h	12 h	12 h	12 h
		1 day	1 day	1 day	1 day	1 day	1 day	1 day	1 day	1 day	1 day	1 day
			2 day	2 day	2 day	2 day	2 day	2 day	2 day	2 day	2 day	2 day
				3 day	3 day	3 day	3 day	3 day	3 day	3 day	3 day	3 day
					5 day	5 day	5 day	5 day	5 day	5 day	5 day	5 day
					7 day	7 day	7 day	7 day	7 day	7 day	7 day	7 day
					10 day	10 day	10 day	10 day	10 day	10 day	10 day	10 day
						14 day	14 day	14 day	14 day	14 day	14 day	14 day
							31 day	31 day	31 day	31 day	31 day	31 day

* for DX102L and DX104L only

8.9 Setting the File Header, Directory Name, and the Saved Data during Manual Save

File header

Up to 32 alphanumeric characters can be used to write a header comment to the display data, event data, manual sampled data, TLOG data (option) and report data (option).

Directory name

When saving data to the external storage medium, you can specify the name of the directory to which the files are to be saved. All data other than the setup data (display data, event data, manual sampled data, TLOG data (option), report data (option), and screen image data) are saved to this directory. Setup data are saved to the root directory.

During auto save, data is saved to the directory specified here.

During manual save, data is saved to the directories with names consisting of the character string specified here followed by a sequence number (see section 8.7).

When saving the data residing in the internal memory to the external storage medium through key operation, data is saved to the directories with names consisting of the character string specified here followed by "A + sequence number" (see section 9.2).

Saved data during manual save

When using manual save, you can select whether to save all the data residing in the internal memory or only the data that have not previously been saved to the storage medium.

Procedure

- These procedures are carried out in the setting mode.
- Use the arrow keys to move the cursor (blue) to the appropriate parameter. (The parameters that cannot be changed are grayed.)
- The possible selections are displayed at the bottom of the screen. Select using the soft keys.
- The parameter boxes that are changed are displayed in yellow. By confirming the new settings, they change back to white.

Press .

Press the soft key .

To display the setting screen press the soft key .

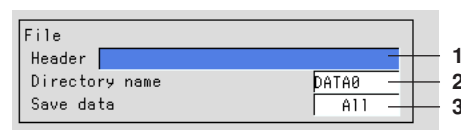

The numbers in front of the operating procedure shown below correspond to the numbers in the above figure.

1. Header
Pressing the [Input] soft key displays a window used to enter a string. Enter the header (up to 32 alphanumeric characters) and press the DISP/ENTER key. For the procedures related to entering character strings, see "Entering Characters" on page 3-22.
2. Directory name
Enter the directory name (up to 8 alphanumeric characters) using the same method as step 1.

8.9 Setting the File Header, Directory Name, and the Saved Data during Manual Save

Note

- The following character combinations can not be used as directory names: "AUX", "CON", "PRN", "NUL", "CLOCK".
 - All spaces, or spaces at the top or in the middle of character strings are also not allowed for directory names.
-

3. Save data

Displayed when [Manual Save] is selected. Select [Unsave] or [All]. The initial setting is [All]

[Unsave]: Saves only the data that have not been saved when the medium is inserted into the drive.

[All]: Save all the data residing in the memory when the medium is inserted into the drive.

Confirming operation

To confirm the new settings, press the DISP/ENTER key.

To cancel the new settings, press the ESC key. A window appears for you to confirm the cancellation. Select [Yes] using the arrow keys and press the DISP/ENTER key.

8.10 Setting the Channels to Display the Trend and Acquire the Data (Basic Setting Mode)

Specify the channel for which the display or event data are to be acquired to the internal memory. The waveforms of the specified channels can be displayed on the trend display.

The waveforms for the channels that are turned OFF are not displayed, but numerical values, bar graphs and alarms are displayed.

Procedure

- These procedures are carried out in the basic setting mode.
- Use the arrow keys to move the cursor (blue) to the appropriate parameter.
- The possible selections are displayed at the bottom of the screen. Select using the soft keys.
- The parameter boxes that are changed are displayed in yellow. By confirming the new settings, they change back to white.

Press .

Press  for 3 seconds. The menu screen for the basic setting mode appears.

To display the setting screen press the soft key .

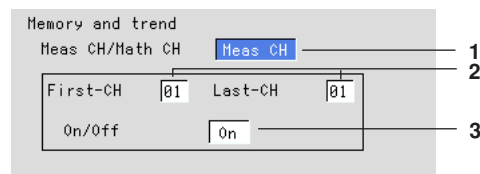

The numbers in front of the operating procedure shown below correspond to the numbers in the above figure.

1. Meas CH/Math CH*
To set the measurement channels, select [Meas CH]. To set the computation channels, select [Math CH].
* [Math CH] appears only on models with the computation option (/M1).
2. First channel and last channel
Select the desired channel numbers.
3. On/Off
[On]: Display the trend/acquire data
[Off]: Do not display the trend/do not acquire data
The initial setting is [On] for all channels.

Confirming operation

To confirm the new settings, press the DISP/ENTER key.

To cancel the new settings, press the ESC key. A window appears for you to confirm the cancellation. Select [Yes] using the arrow keys and press the DISP/ENTER key.

Explanation

The number of measurement and computation channels available in the different models

Model	Measurement Channel	Computation channel
DX102L	2 channels (1 to 2)	4 channels (31 to 34)
DX104L	4 channels (1 to 4)	4 channels (31 to 34)
DX106L	6 channels (1 to 6)	12 channels (31 to 42)
DX112L	12 channels (1 to 12)	12 channels (31 to 42)

8.11 Setting the Method of the Display/Event Data Acquisition (Basic Setting Mode)

Set the method of the display/event data acquisition.

Procedure

- These procedures are carried out in the basic setting mode.
- Use the arrow keys to move the cursor (blue) to the appropriate parameter.
- The possible selections are displayed at the bottom of the screen. Select using the soft keys.
- The parameter boxes that are changed are displayed in yellow. By confirming the new settings, they change back to white.

Press .

Press  for 3 seconds. The menu screen for the basic setting mode appears.

To display the setting screen press the soft key .

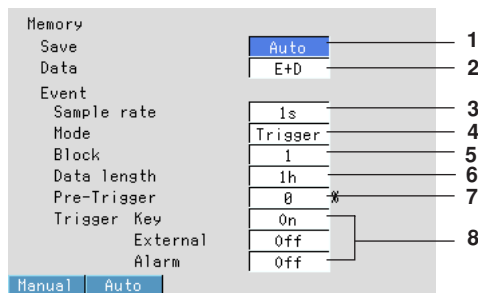

The numbers in front of the operating procedure shown below correspond to the numbers in the above figure.

Data save to the external storage medium

1. Save
Set save method to the external storage medium.
Select [Auto] or [Manual].
[Auto]: auto save
[Manual]: manual save

Note

If [Manual] (manual save) is selected in step 1, set whether to save all the data in the internal memory or only the data that have not been saved. See section 8.9.

Data acquisition

- **Acquiring only the display data**
2. Data
Select [Display].

Note

If [Auto] (auto save) is selected in step 1 and [Display] is selected in step 2, set the auto save interval for the display data. See section 8.8.

8.11 Setting the Method of the Display/Event Data Acquisition (Basic Setting Mode)

- **Acquiring only the event data**

2. Data
Select [Event].
Boxes used to set the method for event data acquisition are displayed.
3. Event - Sample rate
This is the sampling interval for the event data. You cannot specify a sampling interval that is faster than the scan interval.
DX102L, DX104L: 125 ms, 250 ms, 500 ms, 1 s, 2 s, 5 s, 10 s, 30 s, 60 s, 120 s, 300 s, and 600 s
DX106L, DX112L: 1 s, 2 s, 5 s, 10 s, 30 s, 60 s, 120 s, 300 s, and 600 s
4. Event - Mode
Select from [Free], [Trigger], or [Rotate].
If [Free] is selected, item 6 is displayed.
If [Trigger] or [Rotate] is selected, items 5, 6, 7, and 8 are displayed.
5. Event - Block
The event data storage area in the internal memory is divided by the specified number.
Select [1], [2], [4], [8], or [16]. (Select [1], [2], or [4] when acquiring display and event data)
6. Event - Data length
The size of the event data file is expressed as a length of time over which data are acquired.
The data length that can be specified varies depending on the sampling interval ([sample rate] in item 3), number of blocks, and the number of measurement and computation channels that are acquired.
7. Event - Pre-Trigger
This is the range of data to be acquired before the trigger point. It is specified as a percentage of the data length (0, 5, 25, 50, 75, 95, and 100%). If 0% is selected, all data after the trigger point are acquired.
8. Event - Trigger
[Key]: When using key operation to activate the trigger, turn this parameter On.
[External]: When using remote control function (option) to activate the trigger, turn this parameter On.
[Alarm]: When using alarms as triggers, turn this parameter On.

Note

- If the [Alarm] parameter is turned On, trigger is activated if any one of the alarms occurs.
 - If [Alarm] parameter is turned On and the alarm was already activated when the START key is pressed, trigger is also activated.
 - OR logic applies to the [Key], [External], and [Alarm] parameters. If any one of the conditions that are turned On is met, the trigger is activated.
-

- **Acquiring display data and event data**

2. Data type
Select [E+D].

Note

If [Auto] (auto save) is selected in step 1 and [E + D] is selected in step 2, set the auto save interval for the display data. See section 8.8.

8.11 Setting the Method of the Display/Event Data Acquisition (Basic Setting Mode)

Boxes used to set the method for event data acquisition are displayed.

The procedures used to set each parameter are the same as those described for "Acquiring only the event data." In step 4, [Free] is not selectable.

Confirming operation

To confirm the new settings, press the DISP/ENTER key.

To cancel the new settings, press the ESC key. A window appears for you to confirm the cancellation. Select [Yes] using the arrow keys and press the DISP/ENTER key.

Explanation

Choices for the data length

The maximum value of the data length varies depending on the sampling interval. It is also dependent on the type of data to be acquired (display data and event data or event data only) and the number of measurement and computation channels to be acquired (see section 8.10). The available choices for the data length are displayed on the soft key menu. See the table below.

Sample rate (s)	0.125*	0.25*	0.5*	1	2	5	10	30	60	120	300	600
Data length (choices)	3 min	3 min	3 min	3 min	3 min							
	5 min	5 min	5 min	5 min	5 min							
	10 min	10 min	10 min	10 min	10 min	10 min	10 min					
	20 min	20 min	20 min	20 min	20 min	20 min	20 min					
	30 min	30 min	30 min	30 min	30 min	30 min	30 min					
	1 h	1 h	1 h	1 h	1 h	1 h	1 h	1 h	1 h	1 h	1 h	1 h
	2 h	2 h	2 h	2 h	2 h	2 h	2 h	2 h	2 h	2 h	2 h	2 h
	3 h	3 h	3 h	3 h	3 h	3 h	3 h	3 h	3 h	3 h	3 h	3 h
		4 h	4 h	4 h	4 h	4 h	4 h	4 h	4 h	4 h	4 h	4 h
		6 h	6 h	6 h	6 h	6 h	6 h	6 h	6 h	6 h	6 h	6 h
			8 h	8 h	8 h	8 h	8 h	8 h	8 h	8 h	8 h	8 h
			12 h	12 h	12 h	12 h	12 h	12 h	12 h	12 h	12 h	12 h
				1 day	1 day	1 day	1 day	1 day	1 day	1 day	1 day	1 day
					2 day	2 day	2 day	2 day	2 day	2 day	2 day	2 day
						3 day	3 day	3 day	3 day	3 day	3 day	3 day
							5 day	5 day	5 day	5 day	5 day	5 day
								7 day	7 day	7 day	7 day	7 day
									10 day	10 day	10 day	10 day
										14 day	14 day	14 day
											31 day	31 day

* for DX102L and DX104L only

8.12 Specifying the Date/Time When Data Is To Be Saved to the External Storage Medium (Basic Setting Mode)

When the method used to save the data in the internal memory to the external storage medium is set to “auto save,” the display data or event data (only during “Free” mode) in the internal memory is closed as a single file and automatically saved to the external storage medium.

This operation repeats when the auto save interval or the specified date or time is reached.

Procedure

- These procedures are carried out in the basic setting mode.
- Use the arrow keys to move the cursor (blue) to the appropriate parameter.
- The possible selections are displayed at the bottom of the screen. Select using the soft keys.
- The parameter boxes that are changed are displayed in yellow. By confirming the new settings, they change back to white.

Press .

Press  for 3 seconds. The menu screen for the basic setting mode appears.

To display the setting screen press the soft key .

Memory timeup			
Timeup type	Hour		1
Date	1		2
Time(hour)	0		3

The numbers in front of the operating procedure shown below correspond to the numbers in the above figure.

1. Timeup type

If a setting other than [Off] is specified, [Date] or [Day of the week] and [Time(hour)] are displayed.

[Off]: Disable this function.

[Hour]: Saves the data in the internal memory to the external storage medium every hour on the hour.

[Day]: Saves the data in the internal memory to the external storage medium every day at the hour on the hour specified by [Time(hour)].

[Week]: Saves the data in the internal memory to the external storage medium at the day specified by [Day of the week] at the hour on the hour specified by [Time(hour)].

[Month]: Saves the data in the internal memory to the external storage medium at the date specified by [Date] at the hour on the hour specified by [Time(hour)].

8.12 Specifying the Date/Time When Data Is To Be Saved to the External Storage Medium (Basic Setting Mode)

2. Date or Day of the week

When [Timeup type] is set to [Hour], [Day], or [Month], [Date] is displayed. However, the [Date] setting is valid only when [Timeup type] is set to [Month]. It is invalid otherwise.

Pressing the [Input] soft key displays a window used to enter the value. Enter the date (1-28)* and press DISP/ENTER. Procedures related to entering numerical values, see "Entering Numbers" on page 3-21.

* You cannot specify 29, 30, or 31.

When [Timeup type] is set to [Week], [Day of the week] is displayed. Enter the day of the week using the soft key.

3. Time(hour)

Time when data is to be saved. This is invalid when [Timeup type] is set to [Hour].

Enter the hour (00-23) using the same method as step 2.

Confirming operation

To confirm the new settings, press the DISP/ENTER key.

To cancel the new settings, press the ESC key. A window appears for you to confirm the cancellation. Select [Yes] using the arrow keys and press the DISP/ENTER key.

Explanation

When power failure occurs during auto save mode

Acquired data are saved to the storage medium at power restoration. When the power restores, the data saving operation restores.

Example: Timeup type is set to [Hour].

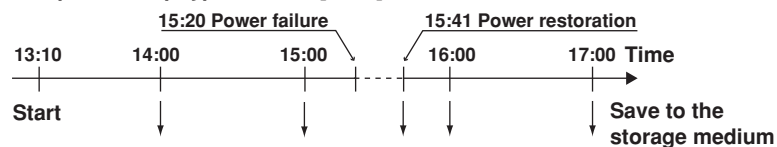

When the data are saved to the storage medium using key operation during auto save mode (see "Explanation" in section 8.7)

The data saving operations are not affected by this key operation.

Example: Timeup type is set to [Hour].

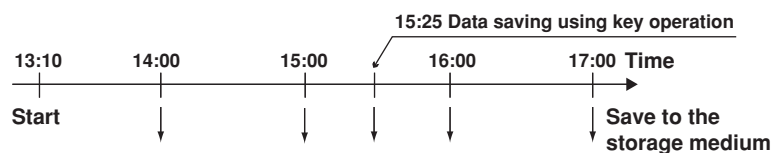

8.13 Storing Measured/Computed Data at Arbitrary Times (Manual Sampling)

The instantaneous values of all measurement and computation channels (excluding the measurement channels that are set to [Skip] and the computation channels that are turned Off) can be stored to the internal memory with a key operation.

Computation channels are options.

For the data format of the manual sampled data, see appendix 2, "Data Formats of ASCII Files."

Procedure

Operation using the FUNC key

This operation is carried out in the operation mode.

1. Press the FUNC key to display the soft key menu.
2. Press the [Manual sample] soft key. The instantaneous values of all channels (excluding the measurement channels that are set to [Skip] and the computation channels that are turned Off) are stored to the internal memory.



Operation using the USER key

This is an operation carried out only when the manual sampling is assigned to the USER key.

1. Press the USER key. The instantaneous values of all channels (excluding the measurement channels that are set to [Skip] and the computation channels that are turned Off) are stored to the internal memory.

9.1 Saving/loading setup data

You can save the setup data to or load setup data from the external storage medium. The operation can be carried out in both the setting mode and the basic setting mode. A setup data file has 25 KB in size (maximum).

Saving setup data (in the setting mode)

Saves the setup data (set in both the setting mode and the basic setting mode) to the external storage medium. The function is the same as that in the basic setting mode.

Procedure

- These procedures are carried out in the setting mode.
- Use the arrow keys to move the cursor (blue) to the appropriate position.

Press .

Press the soft key .

Press  soft key to display the [Save/Load, Clear data] menu screen.

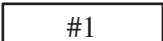
Press  soft key to display the [Save settings] screen.

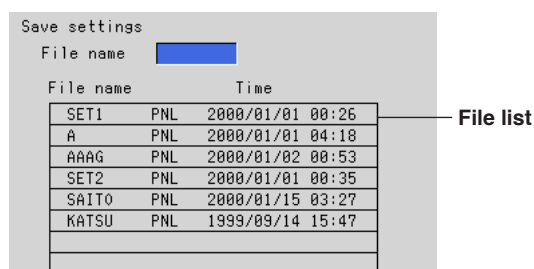

1. Enter the name of the setup data file to be saved.
Pressing the [Input] soft key displays a window used to enter a string. Enter the string (up to 8 alphanumeric characters) and press the DISP/ENTER key. For the procedures related to entering character strings, see “Entering Characters” on page 3-22.
To cancel the operation and return to the [Save/Load, Clear data] menu, press the ESC key.

Note

- The extension “PNL” will automatically be added to the file name.
- The following character combinations cannot be used as file names.
“AUX”, “CON”, “PRN”, “NUL”, “CLOCK”
- All spaces are not allowed for file names.
- Spaces at the top or in the middle of a character string are not allowed.

2. Press the DISP/ENTER key to save the data. The saved file appears in the file list.
If a file with the same name as you entered exists on the external storage medium, a message will appear to confirm overwriting. Select [Yes] or [No] and press the DISP/ENTER key.

9.1 Saving/loading setup data

Loading setup data (in the setting mode)

Loads the setup data set in the setting mode only, from a setup file in the external storage medium and make the settings effective. Setting items that are inconsistent with the content of the basic setting mode of the DX100L will not be acquired. Returns to the operation mode when loading is completed.

Procedure

- These procedures are carried out in the setting mode.
- Use the arrow keys to move the cursor (blue) to the appropriate position.

Press .

Press the soft key .

Press  soft key to display the [Save/Load, Clear data] menu screen.

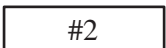
Press  soft key to display the [Load settings] screen.

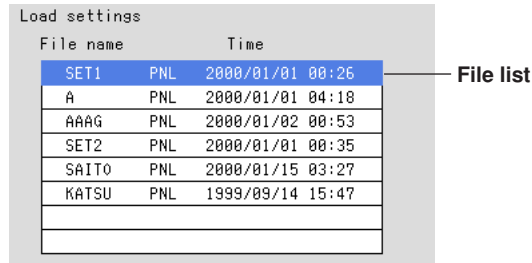

File name		Time
SET1	PNL	2000/01/01 00:26
A	PNL	2000/01/01 04:18
AAAG	PNL	2000/01/02 00:53
SET2	PNL	2000/01/01 00:35
SAITO	PNL	2000/01/15 03:27
KATSU	PNL	1999/09/14 15:47

1. A list of setup files in the storage medium appears.
Select the file to be loaded (The extension of setup files is "PNL").
To cancel the operation and return to the [Save/Load, Clear data] menu, press the ESC key.
2. Press the DISP/ENTER key to load the file.
After loading, the screen returns to the operation mode. The loaded setup data are made effective.

Note

If the loaded data does not take effect, refer to the error log. For the procedure related to displaying the error log, see section 10.7.

Saving setup data (in the basic setting mode)

Saves the setup data (set in both the setting mode and the basic setting mode) to the external storage medium. The created file has the same parameters as the file created in the setting mode.

Procedure

- These procedures are carried out in the basic setting mode.
- Use the arrow keys to move the cursor (blue) to the appropriate position.

Press .

Press  for 3 seconds. The menu screen for the basic setting mode appears.

Press the soft key .

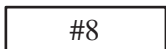
Press  soft key to display the [Save/Load, Initialize] menu screen.

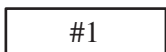
Press  soft key to display the [Save settings] screen.

Save settings		
File name	<input type="text"/>	
File name	Time	
SET1	PNL	2000/01/01 00:26
A	PNL	2000/01/01 04:18
AAAG	PNL	2000/01/02 00:53
SET2	PNL	2000/01/01 00:35
SAITO	PNL	2000/01/15 03:27
KATSU	PNL	1999/09/14 15:47

File list

1. Enter the name of the setup data file to be saved.
Pressing the [Input] soft key displays a window used to enter a string. Enter the string (up to 8 alphanumeric characters) and press the DISP/ENTER key. For the procedures related to entering character strings, see “Entering Characters” on page 3-22.
To cancel the operation and return to the [Save/Load, Initialize] menu, press the ESC key.

Note

- The extension “PNL” will automatically be added to the file name.
- The following character combinations cannot be used as file names.
“AUX”, “CON”, “PRN”, “NUL”, “CLOCK”
- All spaces are not allowed for file names.
- Spaces at the top or in the middle of a character string are not allowed.

2. Press the DISP/ENTER key to save the data. The saved file appears in the file list.
If a file with the same name as you entered exists on the external storage medium, a message will appear to confirm overwriting. Select [Yes] or [No] and press the DISP/ENTER key.

9.1 Saving/loading setup data

Loading setup data (in the basic setting mode)

Loads the setup data (set in both the setting mode and the basic Setting mode) from a setup file in the external storage medium and make the settings effective.

Returns to the operation mode when loading is completed.

Procedure

- These procedures are carried out in the basic setting mode.
- Use the arrow keys to move the cursor (blue) to the appropriate position.

Press .

Press  for 3 seconds. The menu screen for the basic setting mode appears.

Press the soft key .

Press  soft key to display the [Save/Load, Initialize] menu screen.

Press  soft key to display the [Load settings] screen.

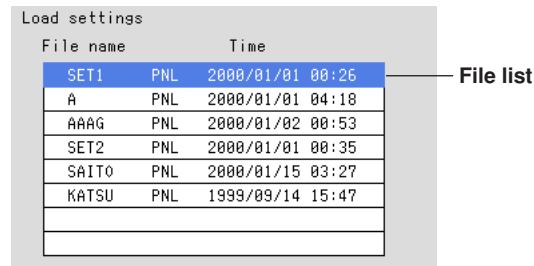

File name	Time
SET1 PNL	2000/01/01 00:26
A PNL	2000/01/01 04:18
AAAG PNL	2000/01/02 00:53
SET2 PNL	2000/01/01 00:35
SAITO PNL	2000/01/15 03:27
KATSU PNL	1999/09/14 15:47

1. A list of setup files in the storage medium appears.
Select the file to be loaded (The extension of setup files is "PNL").
To cancel the operation and return to the [Save/Load, Initialize] menu, press the ESC key.
2. Press the DISP/ENTER key to load the file.
After loading, the screen returns to the operation mode. The loaded setup data take effect.

Note

If the loaded data does not take effect, refer to the error log. For the procedure related to displaying the error log, see section 10.7.

9.2 Saving data in the internal memory to the external storage medium using key operation

The following data in the internal storage memory are saved to the external storage medium using key operation.

Display data/Event data/Manual sampled data/TLOG data (option)/Report data (option)

Procedure

These procedures are carried out in the setting mode.

Press .

Press the soft key .

Press  soft key to display the [Save/Load, Clear data] menu screen.

Press  [Save data] soft key to save the data in the internal memory to the external storage medium.

Note

The data in the internal memory cannot be saved to the external storage medium while data acquisition or computation is in progress.

Explanation

Name of the directory to which to save the data

The name of the directory to which to save the data is “the specified name”. Axx, where xx is the sequence number. Each time carrying out the key operation and the data are saved, the sequence number of the directory name increments by one.

Example: When the specified directory name is “DATA0”, the first set of data are saved to “DATA0.A00” and the second set of data are saved to “DATA0.A01.”

9.3 Viewing Display Data in the External Storage Medium

Loads the display data saved in the external storage medium and displays the waveform on the historical trend screen. This operation can be carried out when the acquisition of display data is set ([Display] or [E+D] in section 8.11). See section 4.6, for the use of the historical trend.

Procedure

- These procedures are carried out in the setting mode.
- Use the arrow keys to move the cursor (blue) to the appropriate position.

Press .

Press the soft key .

Press  soft key to display the [Save/Load, Clear data] menu screen.

Press  soft key to display the [Load display data] screen.

Load display data			
Directory	File name	Time	
/	10100580 DDS	2000/01/01 00:59	File list
DATA23	10104120 DDS	2000/01/01 04:12	
HS2	10104130 DDS	2000/01/01 10:14	
DATA21	10105130 DDS	2000/01/01 10:14	
DATA22	10106130 DDS	2000/01/01 10:14	
TRASH	10110090 DDS	2000/01/01 10:15	

For models with the batch function (/BT1 option), press the [Time] soft key when displaying the date and time of file creation and the [Batch] soft key when displaying the batch number and lot number.

1. The directories in the external storage medium are displayed in the [Directory name] column. Press the up or down arrow key to select the directory containing the display data to be loaded. A list of files in the selected directory is displayed in the right column. Root directory is denoted by [/].
2. Press the right arrow key to move the cursor on to the file list. Press the up or down arrow key to select the display data file to be loaded. To move back to the [Directory name] column, press the left arrow key.
3. Press the DISP/ENTER key to display the waveform on the historical trend screen. To return to the [Save/Load, Clear data] menu screen without displaying the historical trend, press the ESC key.

9.4 Viewing Event Data in the External Storage Medium

Loads the event data saved in the external storage medium and displays the waveform on the historical trend screen. This operation can be carried out when the acquisition of event data is set ([Event] or [E+D] in section 8.11). See section 4.6, for the use of the historical trend.

Procedure

- These procedures are carried out in the setting mode.
- Use the arrow keys to move the cursor (blue) to the appropriate position.

Press .

Press the soft key .

Press  soft key to display the [Save/Load, Clear data] menu screen.

Press the soft key .

Press  soft key to display the [Load event data] screen.

Load event data			
Directory	File name	Time	
/	10306230 DEV	2000/01/03 06:24	File list
DATA23	10307210 DEV	2000/01/03 07:21	
HS2	10307220 DEV	2000/01/03 07:22	
DATA21	10307221 DEV	2000/01/03 07:22	
DATA22			
TRASH			

For models with the batch function (/BT1 option), press the [Time] soft key when displaying the date and time of file creation and the [Batch] soft key when displaying the batch number and lot number.

1. The directories in the external storage medium are displayed in the [Directory name] column. Press the up or down arrow key to select the directory containing the event data to be loaded. A list of files in the selected directory is displayed in the right column. Root directory is denoted by [/].
2. Press the right arrow key to move the cursor on to the file list. Press the up or down arrow key to select the event data file to be loaded. To move back to the [Directory name] column, press the left arrow key.
3. Press the DISP/ENTER key to display the waveform on the historical trend screen. To return to the [Save/Load, Clear data] menu screen without displaying the historical trend, press the ESC key.

9.5 Managing files/Displaying free space on the external storage medium

Displays a list of files and the amount of free space on the external storage medium (in the setting mode only).

Deletes files and directories on the external storage medium.

Formats the external storage medium.

Display the list of files and the free space on the external storage medium (in the setting mode)

A list of files on the external storage medium can be displayed. In addition, the amount of free space is also displayed.

Procedure

- These procedures are carried out in the setting mode.
- Use the arrow keys to move the cursor (blue) to the appropriate position.

Press .

Press the soft key .

Press  soft key to display the [Save/Load, Clear data] menu screen.

Press the soft key .

Press  soft key to display the [File list] screen.

File list			
Directory	File name	Time	
/	SET1	PNL	2000/01/01 00:26
B	A	PNL	2000/01/01 04:18
B 000	AAAG	PNL	2000/01/02 00:53
B 001	SET2	PNL	2000/01/01 00:35
B 002	SAITO	PNL	2000/01/15 03:27
B 003	KATSU	PNL	1999/09/14 15:47
	VR1000H	LZH	1999/08/28 10:32
	VRSUB00	LZH	1999/08/17 22:56
Free space	98472 Kbytes		

File list

1. The directories in the external storage medium are displayed. Using the arrow keys select the directory. Files in the directory are listed to the right. [/] is the root directory.
2. Pressing the right arrow key moves the cursor to the file list. The list can be scrolled using the arrow keys. To move back to the [Directory name] column, press the left arrow key.
3. Free space
Displays the amount of free space on the external storage medium.
4. Press the ESC key to return to the [Save/Load, Clear data] menu screen.

Deleting files and directories on the external storage medium (in the setting mode)

Deletes files and directories on the external storage medium. The function is the same as that in the basic setting mode.

Procedure

- These procedures are carried out in the setting mode.
- Use the arrow keys to move the cursor (blue) to the appropriate position.

Press .

Press the soft key .

Press  soft key to display the [Save/Load, Clear data] menu screen.

Press the soft key .

Press  soft key to display the [Delete] screen.

Delete			
Directory	File name	Time	
/	SET1	PNL	2000/01/01 00:26
B	A	PNL	2000/01/01 04:18
B 000	AAAG	PNL	2000/01/02 00:53
B 001	SET2	PNL	2000/01/01 00:35
B 002	SAITO	PNL	2000/01/15 03:27
B 003	KATSU	PNL	1999/09/14 15:47
	VR1000H	LZH	1999/08/28 10:32
	VRSUB00	LZH	1999/08/17 22:56

File list

Deleting a file in a directory

1. Of the directories listed in the [Directory name] column, select the directory in which the file you wish to delete exists using the up and down arrow keys. The [File name] column displays a list of files in the selected directory. [/] is the root directory.
2. Pressing the right arrow key moves the cursor onto the [File name] column. Use the up and down arrow keys to select the file to be deleted.
3. Pressing the DISP/ENTER key displays a confirmation dialog box.
4. Use the arrow keys to select [Yes] and press the DISP/ENTER key to delete the selected file. The file is cleared from the file list.
To cancel the delete operation, select [No] and press the DISP/ENTER key.

Note

If the ESC key is pressed in the middle of the operation, the screen returns to the [Save/Load, Clear Data] menu.

Deleting all the files in the directory

1. Of the directories listed in the [Directory name] column, select the directory in which the files you wish to delete exist using the up and down arrow keys. The [File name] column displays a list of files in the selected directory. [/] is the root directory.
2. Pressing the DISP/ENTER key displays a confirmation dialog box.
3. Use the arrow keys to select [Yes] and press the DISP/ENTER key to delete all the files in the directory. All files are cleared from the file list.
To cancel the delete operation, select [No] and press the DISP/ENTER key.

Note

If the ESC key is pressed in the middle of the operation, the screen returns to the [Save/Load, Clear Data] menu.

Deleting a directory

A directory can be deleted if there are no files in the directory. To delete a directory that has files, delete all the files in the directory first.

1. Of the directories listed in the [Directory name] column, select the directory you wish to delete using the up and down arrow keys. Check that no files are displayed in the [File name] column. [/] is the root directory. The root directory cannot be deleted.
2. Pressing the DISP/ENTER key displays a confirmation dialog box.
3. Use the arrow keys to select [Yes] and press the DISP/ENTER key to delete the directory. The directory name is cleared from the [Directory name] column.
To cancel the delete operation, select [No] and press the DISP/ENTER key.

Note

If the ESC key is pressed in the middle of the operation, the screen returns to the [Save/Load, Clear Data] menu.

Formatting the external storage medium (in the setting mode)

Formats the external storage medium. The function is the same as the formatting the external storage medium in the basic setting mode.

Procedure

- These procedures are carried out in the setting mode.
- Use the arrow keys to move the cursor (blue) to the appropriate position.

Press .

Press the soft key .

Press  soft key to display the [Save/Load, Clear data] menu screen.

Press the soft key .

Press  soft key to display the [Format] screen.

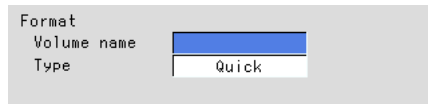

1. To change the volume name after formatting, enter the new volume name. Pressing the [Input] soft key displays a window used to enter a string. Enter the string (up to 11 alphanumeric characters) and press the DISP/ENTER key. For the procedures related to entering character strings, see “Entering Characters” on page 3-22.

Note

- The following character combinations cannot be used as volume names. “AUX”, “CON”, “PRN”, “NUL”, “CLOCK”
- All spaces are not allowed for volume names.
- Spaces at the top or in the middle of a character string are not allowed.

2. Select [Quick] or [Normal] to set in the [Type] box. To cancel the operation and return to the [Save/Load, Clear data] menu, press the ESC key.
3. Pressing the DISP/ENTER key displays a confirmation window. Use the arrow keys to select [Yes] and press the DISP/ENTER key to format the medium.

Explanation

Type

[Quick]: Performs only a logical format.

[Normal]: Performs both a physical format and a logical format.

Format type

Floppy disk: 2HD, 1.44 MB

Zip disk: FDISK 1 partition (hard disk format)

ATA flash memory card: FDISK 1 partition (hard disk format)

Format time

Type of storage media	Quick	Normal	Note
Floppy disk	Approx. 6 s	Approx. 1 min. 30 s	
Zip disk	Approx. 3 s	Approx. 10 min.	
ATA flash memory card	Approx. 3 s Approx. 5 s	Approx. 1 min. 30 s Approx. 6 min.	20 MB 160 MB

Deleting files and directories on the external storage medium (in the basic setting mode)

Deletes files and directories on the external storage medium. The function is the same as that in the setting mode.

Procedure

- These procedures are carried out in the basic setting mode.
- Use the arrow keys to move the cursor (blue) to the appropriate position.

Press .

Press  for 3 seconds. The menu screen for the basic setting mode appears.

Press the soft key .

Press  soft key to display the [Save/Load, Initialize] menu screen.

Press  soft key to display the [Delete] screen.

Directory	File name	Time
/	SET1	PNL 2000/01/01 00:26
B	A	PNL 2000/01/01 04:18
B 000	AAAG	PNL 2000/01/02 00:53
B 001	SET2	PNL 2000/01/01 00:35
B 002	SAITO	PNL 2000/01/15 03:27
B 003	KATSU	PNL 1999/09/14 15:47
	VR1000H	LZH 1999/08/28 10:32
	VRSUB00	LZH 1999/08/17 22:56

File list

Deleting files and directories can be executed in the same procedure as that in the setting mode. See page 9-9.

Formatting the external storage medium (in the basic setting mode)

Formats the external storage medium. The function is the same as that in the setting mode.

Procedure

- These procedures are carried out in the basic setting mode.
- Use the arrow keys to move the cursor (blue) to the appropriate position.

Press .

Press  for 3 seconds. The menu screen for the basic setting mode appears.

Press the soft key .

Press  soft key to display the [Save/Load, Initialize] menu screen.

Press  soft key to display the [Format] screen.

Format	
Volume name	<input type="text"/>
Type	Quick

Formatting the external storage medium can be executed in the same procedure as that in the setting mode. See page 9-11.

9.6 Saving the Screen Image

The screen image that is displayed is saved to the external storage medium using the FUNC key or USER key* operation. The data size of the screen image is approximately 12 KB/screen.

* Only when [Snapshot] is assigned to the USER key. See sections 10.2.

Procedure

FUNC key operation

This operation is carried out in the operation mode. The images of soft keys or messages are not saved.

1. Confirm the storage medium is in the drive.
2. Press the FUNC key to display the soft key menu.
3. Press the [Snapshot] soft key. The screen image is saved to the external storage medium.



USER key operation

This applies only when [Snapshot] is assigned to the USER key.

This key operates in all run modes (operation, setting, and basic setting modes). The exact screen image that is displayed when the USER key is pressed is saved. However, error messages are not saved.

1. Confirm the storage medium is in the drive.
2. Press the USER key. The screen image is saved to the external storage medium.

Explanation

File format

Screen image data is in "PNG" format.

File name

File names are automatically assigned (Month, date, hour, and minute when the screen image data were stored + sequence number) to screen image data files.

Mddhhmma. PNG

where, M: month (1 to 9, X (10), Y (11), Z (12)), dd: date, hh: hour, mm: minute, a: sequence number

Note

The sequence number of the file name is normally set to 0. However, if the screen image data is saved twice within a minute, for example, then the file name of the two files will have sequence numbers 0 and 1 for the first and second files, respectively. (The two files will have the same Mddhhmm (month/day/hour/minute) section.)

9.7 Clearing Data from the Internal Memory

Clears display data, event data, manual sampled data, TLOG data (option), and report data (option) from the internal memory.

Procedure

- These procedures are carried out in the setting mode.
- Use the arrow keys to move the cursor (blue) to the appropriate position.

Press .

Press the soft key .

Press  soft key to display the [Save/Load, Clear data] menu screen.

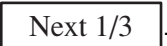
Twice press the soft key .

Press  [Clear data] soft key to display a confirmation window.

Selecting [Yes] and pressing the DISP/ENTER key clears the data from the internal memory.

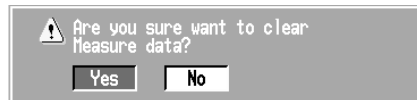

9.8 Initializing Setup Data

Initializes the setup data in the internal memory. Also Clears display data, event data, manual sampled data, TLOG data (option), report data (option), and logs from the internal memory. The DX100L returns to the operation mode .
For the initial settings of the setup data, see Appendix 1.

Procedure

These procedures are carried out in the basic setting mode.

Press .

Press  for 3 seconds. The menu screen for the basic setting mode appears.

Press the soft key .

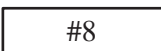
Press  soft key to display the [Save/Load, Initialize] menu screen.

Press  soft key to display the [Initialize] screen.

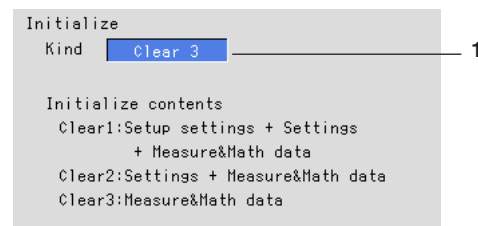

1. Select the type of initialization to set in the [Type] box.
To cancel the operation and return to the [Save/Load, Initialize] menu, press the ESC key.
[Clear 1]: Initializes the settings in the basic setting mode, settings in the setting mode and clears the internal memory.
[Clear 2]: Initializes the settings in the setting mode and clears the internal memory.
[Clear 3]: Clears the internal memory.
2. Pressing the DISP/ENTER key displays a confirmation window. Pressing the DISP/ENTER key initializes the settings and returns to the operation mode.

10.1 USER Key

An action can be assigned to the user key. For details of actions, see section 10.2. "Alarm Ack" (see chapter 6) is assigned as the initial value.

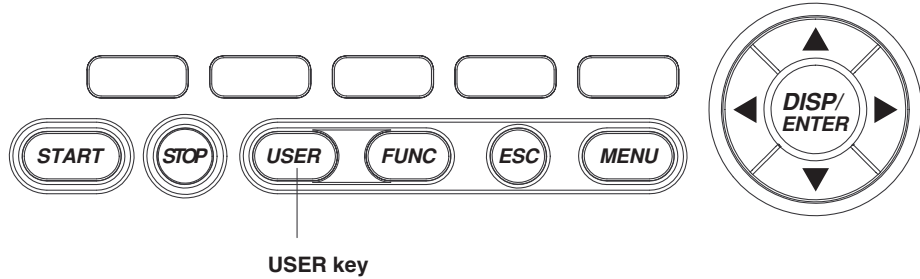

Executing the action that has been assigned

Procedure

For the operating procedure, see sections listed below.

Assigned action (soft key)	Reference section
None	-
Trigger	8.6
AlarmACK	6.1
Math	11.3
Math rst	11.3
M.sample	8.13
Message1 to Message8	7.4
Snapshot	9.6

10.2 Assigning an Action to the USER Key

Procedure

- These procedures are carried out in the setting mode.
- Use the arrow keys to move the cursor (blue) to the appropriate parameter. (The parameters that cannot be changed are grayed.)
- The possible selections are displayed at the bottom of the screen. Select using the soft keys.
- The parameter boxes that are changed are displayed in yellow. By confirming the new settings, they change back to white.

Press .

To display the setting screen press the soft key .

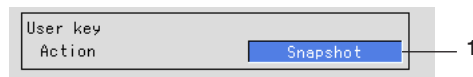

The numbers in front of the operating procedure shown below correspond to the numbers in the above figure.

1. Action
Selecting the action to be assigned.

Confirming operation

To confirm the new settings, press the DISP/ENTER key.

To cancel the new settings, press the ESC key. A window appears for you to confirm the cancellation. Select [Yes] using the arrow keys and press the DISP/ENTER key.

Explanation

Actions that can be assigned.

Soft Key	Ref. section	Action
None	-	No operation
Trigger	8.6	Provides a key trigger for starting acquiring the event data. (when [Key Trigger] is set as a trigger to start acquiring event data, see section 8.11.)
AlarmACK	6.1	Release alarm indication and relay output (when alarm display and alarm output relay action is set to "hold," section 6.4.)
Math	11.3	Starts/stops computation. (when the computation function (/M1) is equipped)
Math rst	11.3	Clears computed results. (when the computation function (/M1) is equipped and the computation is suspended)
M.sample	8.13	Stores instantaneous values of all channels to the internal memory.
Message 1 to 8	7.4	Displays messages and stores them to the internal memory.
Snapshot	9.6	Save the screen image data to the storage medium.

* Snapshot works in all modes. Other actions work in the operation mode or the setting mode.

10.3 Using Key Lock

Key lock is a function used to prevent key operations, Zip disk removal, and saving data to the external storage medium in the manual save mode.

To release a key lock, you must enter a password.

The key lock ON/OFF condition is retained even if the power is turned OFF. Thus, the next time the power is turned ON, the preexisting state is restored.

Key lock is set in the basic setting mode.

Procedure

Enabling key lock

This operation is carried out in the operation mode.

1. Press the FUNC key to display the soft key menu.
2. Press the [Keylock] soft key. The key lock function is enabled.



Note

- If a locked key is pressed when the key lock function is engaged, a message "This key is locked." is displayed.
- A key lock icon appears in the status display section when the key lock is enabled. See section 4.2.

Releasing the key lock

This operation is carried out in the operation mode.

1. Press the FUNC key to display the soft key menu.
2. Press the [Keylock] soft key. A window appears for you to enter the password.

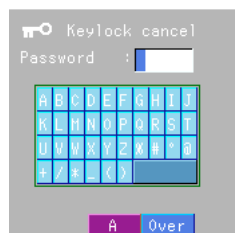

3. Enter the password and press the DISP/ENTER key. (The password is set in the basic setting mode. See section 10.4.) For the procedures related to entering character strings, see "Entering Characters" on page 3-22. The key lock is released.

10.4 Setting the Key Lock Function (Basic Setting Mode)

Select whether or not to enable the key lock on the individual keys and the external storage medium. The initial setting is [Free] (disabled) on all parameters.

Procedure

- These procedures are carried out in the basic setting mode.
- Use the arrow keys to move the cursor (blue) to the appropriate parameter.
- The possible selections are displayed at the bottom of the screen. Select using the soft keys.
- The parameter boxes that are changed are displayed in yellow. By confirming the new settings, they change back to white.

Press .

Press  for 3 seconds. The menu screen for the basic setting mode appears.

Press the soft key .

To display the setting screen press the soft key .

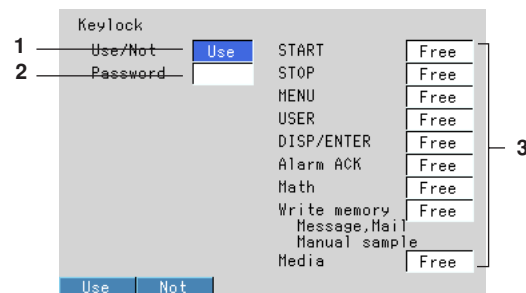

The numbers in front of the operating procedure shown below correspond to the numbers in the above figure.

1. Use/Not
Select [Use] or [Not]. If [Use] is selected, various parameters are displayed.
[Use]: Use key lock.
[Not]: Do not use key lock.
2. Password
Set the password used to release the key lock in the operation mode.
Pressing the [Input] soft key displays a window used to enter a string. Enter the string (up to 6 alphanumeric characters) and press the DISP/ENTER key. For the procedures related to entering character strings, see “Entering Characters” on page 3-22.
3. For each parameter, select whether or not to enable the key lock.
[Free]: Disable
[Lock]: Enable

Confirming operation

To confirm the new settings, press the DISP/ENTER key.

To cancel the new settings, press the ESC key. A window appears for you to confirm the cancellation. Select [Yes] using the arrow keys and press the DISP/ENTER key.

Explanation

Key locked parameter and the behavior during key lock (can be set individually)

Parameter	Behavior during key lock
[START] key	Disabled
[STOP] key	Disabled
[MENU] key	Disabled
[USER] key	Disabled
[DISP/ENTER] key	Disabled to change operation screens
[Alarm ACK] soft key	Disabled
Math (Computation)	
• [Math START] soft key ^{*1}	Disabled
• [Math STOP] soft key ^{*1}	Disabled
• [Math reset] soft key ^{*1}	Disabled
Write memory	
• [Message] soft key ^{*2}	Disabled
• [Manual sample] soft key ^{*2}	Disabled
• [Trigger] soft key ^{*2}	Disabled
• [Save Display] soft key ^{*2}	Disabled
• [Save Event] soft key ^{*2}	Disabled
• [E-Mail START] soft key ^{*2*3}	Disabled
• [E-Mail STOP] soft key ^{*2*3}	Disabled
• [E-Mail test] soft key ^{*2}	Disabled
Media (External storage medium)	
• During manual save	Prevent saving when an external storage medium is inserted, Prevent Zip disk removal.
• During auto save	Prevent Zip disk removal.

*1 Set together by [Math] parameter.

*2 Set together by [Write memory] parameter.

*3 Can be set when the e-mail transmission function is engaged.

10.5 Using the Key Login/Logout Function

This function allows only certain users to access the DX100L. The users are distinguished by their user IDs and passwords. You can select whether or not to use User IDs. In addition, you can set whether or not to allow operations in the basic setting mode for each user. When logged out, only the login operation can be accessed. Enabling/Disabling the key login/logout and using/not using the user ID are set in the basic setting mode. See the next section.

When logged in, the user name is displayed in the status display section. See section 4.2.

The records of key login/logout can be viewed on the log screen. See section 10.7.

Note

When the power is turned OFF and turned ON again, the DX100L starts in the logged out condition.

Procedure

Logging in

1. Press the FUNC key. Soft keys and a list of user names are displayed.
2. Select the user using the soft key.



3. When using the user ID, a window appears for you to enter the user ID. Enter the user ID and press the DISP/ENTER key. For the procedures related to entering character strings, see "Entering Characters" on page 3-22.



4. A window appears for you to enter the password. Enter the password and press the DISP/ENTER key. For the procedures related to entering character strings, see "Entering Characters" on page 3-22.



The user name is displayed in the status display section.

User name



Logging out

1. Press the FUNC key. The [Logout] soft key is displayed.
2. Press the [Logout] soft key. The user name shown in the status display section disappears.



Auto logout

This function is available in the operation mode.

If there is no key operation for ten minutes, the user is automatically logged out. The auto logout function can be activated in the basic setting mode.

Explanation

Power up operation

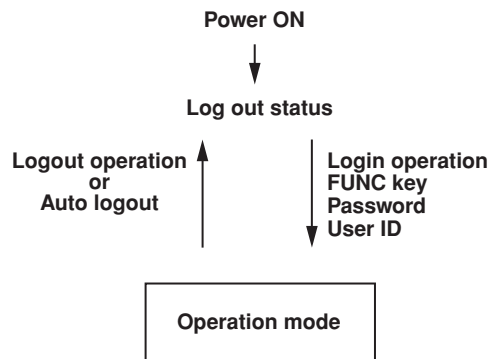

When the basic setting mode is terminated

When the basic setting mode is terminated and the mode returns to the operation mode, the DX100L is in the logged out condition.

Saving the user name

The user name is stored to the display and event data files at the following points: when the display or event data acquisition starts and ends and when a message is written.

10.6 Setting the Key Login/Logout Functions (Basic Setting Mode)

Procedure

- These procedures are carried out in the basic setting mode.
- Use the arrow keys to move the cursor (blue) to the appropriate parameter.
- The possible selections are displayed at the bottom of the screen. Select using the soft keys.
- The parameter boxes that are changed are displayed in yellow. By confirming the new settings, they change back to white.

Press .

Press  for 3 seconds. The menu screen for the basic setting mode appears.

Press the soft key .

To display the setting screen press the soft key .

Key login		
Use/Not	Use	1
Auto logout	Off	2
UserID Use/Not	Use	3
Number	1	4
On/Off	On	5
User name	user1	6
User ID		7
Password		8
Enter setup	Enable	9

The numbers in front of the operating procedure shown below correspond to the numbers in the above figure.

1. Use/Not
Select [Use] or [Not]. If [Use] is selected, items 2, 3, 4, 5, 6, 8, and 9 are displayed.
[Use]: Use key login.
[Not]: Do not use key login.
2. Auto logout
Select [On] or [Off].
[On]: Use the auto logout.
[Off]: Do not use the auto logout.
3. User ID Use/Not
[Use]: Use the user ID.
[Not]: Do not use the user ID.
If [Use] is selected, item 7 (User ID) appears.

Note

For models with the batch function, The key login function of all users (1 to 7, item 4) turns [Off] (item 5), when [User ID] is changed to [Use] from [Not].

4. Number
This is the user registration number (1 to 7). Select the user number to be set.
5. On/Off
Set whether or not to enable the key login function for the selected user.
[On]: Enable the key login function for the selected user.
[Off]: Disable the key login function for the selected user.

6. User name
Enter the user name (up to 16 alphanumeric characters).
Pressing the [Input] soft key displays a window used to enter a string. Enter the string and press the DISP/ENTER key. For the procedures related to entering character strings, see "Entering Characters" on page 3-22.

Note

- For models with the batch function (/BT1 option), duplicate user names cannot be registered. See "Confirming operation" below.
 - "quit" cannot be used as the user name.
 - All spaces are also not allowed for the user name.
-

7. User ID
Enter the user ID (up to 4 alphanumeric characters) using the same method as step 6.
8. Password
Enter the password (up to 6 alphanumeric characters) using the same method as step 6.

Note

For models with the batch function (/BT1 option), the combinations of user IDs and passwords that are identical to those that have been registered by any user in the past cannot be specified. See "Confirming operation" below.

9. Enter setup
Select whether or not to allow the login user to enter the basic setting mode.
[Enable]: The user can enter the basic setting mode.
[Disable]: The user can not enter the basic setting mode.

Note

The [Enter Setup] of all users cannot be set to [Disabled]. If specified, the user with the lowest registration number with the fifth parameter turned [On] is automatically set to [Enabled] (The setting is changed when the setup data is stored and the basic setting mode is terminated.).

Confirming operation

To confirm the new settings, press the DISP/ENTER key.

- **For models without the batch function (/BT1 option)**
 - If the user name already exists, a confirmation message "This user name is already registered," is displayed. At this point the user name is registered. If necessary, change the user name to be registered.
- **For models with the batch function (/BT1 option),**
 - If the user name already exists, an error message "This user name is already registered," is displayed. The user name entry box stays yellow, and the user name is not registered. Change the user name to be registered.
 - If the combination of the user ID and password that are identical to those that have been registered by any user in the past, an error message "Duplicate used combination of user ID and password," is displayed. Change the combination of the user ID and password to be registered.

To cancel the new settings, press the ESC key. A window appears for you to confirm the cancellation. Select [Yes] using the arrow keys and press the DISP/ENTER key.

10.7 Displaying the Log Screen/System Screen

The following list is displayed on the log screen.

- Error messages (the newest 50)
- A record of key login/logout (the newest 50)
- A record of communication commands (the newest 200)
- A record of file transfers made using the FTP client function (the newest 50)
- A record of web operation (the newest 50)
- A record of e-mail transmission (the newest 50)

If the number exceeds the limit, entries are deleted starting with the oldest one.

The number of input points, capacity of the internal memory, options, MAC address, and the firmware version number of the DX100L can be displayed on the screen for confirmation.

Procedure

Display the log screen/system screen

1. Press the FUNC key to display the soft key menu.
2. Press the [Log] soft key. The types of logs that can be displayed and the system screen are assigned to the soft keys and displayed.



3. Press a soft key to display the log.
[Error] soft key: Displays a log of error messages.
[Key login] soft key: Displays a log of key login/logout.
[Commu] soft key: Displays a log of communication commands that have been executed.
[FTP] soft key: Displays a log of file transfers made using the FTP client function.
[Web] soft key: Displays a log of operations on the Web screen.
[E-Mail] soft key: Displays a log of e-mail transmission.
[System] soft key: Displays a system screen.
4. Use the up and down keys to scroll through the log.

Returning to the operation screen

To return to the operation screen from the log screen or the system screen, press the DISP/ENTER key to display the screen menu, select the desired screen using the up and down arrow keys, and then press the DISP/ENTER key.

Explanation

Error message log

The number of the log displayed at the last line of the screen / total number of logs

Date and time of occurrence	Error code	Error message
(002/002) Time	No.	Message

Jan.31.2001 07:23:33	210	Media has not been inser..
Jan.31.2001 07:23:23	601	Measured data have been ..

Key login/logout log

The number of the log displayed at the last line of the screen / total number of logs

(003/003)	Time	I/O	No.	User Name
Jan.31.2001	07:13:15	In	01	user1
Jan.31.2001	07:12:58	Out		
Jan.31.2001	07:12:46	In	01	user1

User name
User No.
Date/time Login/logout

Communication command log

The number of the log displayed at the last line of the screen / total number of logs

(000/000)	Time	ID	I/O	Message	Link
Jan.31.2001	07:23:33	1	<	(Logout)	
Jan.31.2001	07:23:23	1	>	CC 0	

Ethernet interface
Green: Good connection
Gray: No connection

Message
I/O symbol (>: input, <: output)
A number used to identify the user that is connected
Date and time when the access occurred

FTP log

The number of the log displayed at the last line of the screen / total number of logs

(002/002)	Time	No.	Code	Flag	File Name
Jan.31.2001	06:58:08	282	HOSTNAME	S	13106580.DHR
Jan.31.2001	06:58:08	282	HOSTNAME	P	13106580.DHR

File name
FTP server (P: primary, S: secondary)
Error code
Date and time when the file transfer was made

Web operation log

The number of the log displayed at the last line of the screen / total number of logs

(003/003)	Time	Request	No.	Parameter
Jan.31	06:52:38	Key		DOWN
Jan.31	06:51:21	Screen		TREND GROUP=2
Jan.31	06:50:28	Message	155	1:start

Operation
Date/time Type Error code (see chapter 12)

E-mail log

The number of the log displayed at the last line of the screen / total number of logs

(004/004)	Time	Type	No.	Recipient / Error
Jan.31	06:16:49	Alarm	264	1 Some recipients' a..
Jan.31	06:16:19	Alarm		1 H_S
Jan.31	06:16:17	Fail		1+2 H_S uu
Jan.31	06:15:53	Alarm		1 H_S

Recipient address
Recipient No.
Error code (see chapter 12)
Date/time Mail type

System screen

See section 1.8.

10.8 Setting the Memory Alarm Time (/F1 Option Provides an Relay Output Alarm, Basic Setting Mode)

When the remaining time for storing the display or event data in the internal memory falls to the specified time (Memory alarm) during manual save, an alarm is generated via e-mail or the relay contact output (/F1 option). For details related to the relay output action, see section 1.8.

Procedure

- These procedures are carried out in the basic setting mode.
- Use the arrow keys to move the cursor (blue) to the appropriate parameter.
- The possible selections are displayed at the bottom of the screen. Select using the soft keys.
- The parameter boxes that are changed are displayed in yellow. By confirming the new settings, they change back to white.

Press .

Press  for 3 seconds. The menu screen for the basic setting mode appears.

Press the soft key .

To display the setting screen press the soft key .

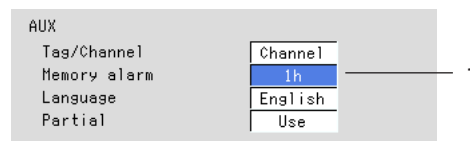

The numbers in front of the operating procedure shown below correspond to the numbers in the above figure.

1. **Memory alarm**
This is the minimum storage time of the internal memory at which the relay should be activated.
Select a value from [1 h], [2 h], [5 h], [10 h], [20 h], [50 h], [100 h] and [off].
[Off]: Memory alarm function is disabled (the function does not operate in either manual save or auto save (see section 1.8)).

Confirming operation

To confirm the new settings, press the DISP/ENTER key.

To cancel the new settings, press the ESC key. A window appears for you to confirm the cancellation. Select [Yes] using the arrow keys and press the DISP/ENTER key.

10.9 Setting the Remote Control Functions (/R1 Option, Basic Setting Mode)

Various actions can be assigned to the eight remote control terminals. The assigned action can then be executed by applying a remote input signal to the corresponding terminal.

Procedure

- These procedures are carried out in the basic setting mode.
- Use the arrow keys to move the cursor (blue) to the appropriate parameter.
- The possible selections are displayed at the bottom of the screen. Select using the soft keys.
- The parameter boxes that are changed are displayed in yellow. By confirming the new settings, they change back to white.

Press .

Press  for 3 seconds. The menu screen for the basic setting mode appears.

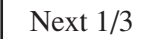
Twice press the soft key .

Press the soft key .

To display the setting screen press the soft key .

Remote No.	Action
1	None
2	None
3	None
4	None
5	None
6	None
7	None
8	None

The number 1 in the original image points to the first row of the table.

The numbers in front of the operating procedure shown below correspond to the numbers in the above figure.

1. Action
Assign actions to Remote numbers 1 to 8. For the functions that can be assigned, see the explanation.

Confirming operation

To confirm the new settings, press the DISP/ENTER key.

To cancel the new settings, press the ESC key. A window appears for you to confirm the cancellation. Select [Yes] using the arrow keys and press the DISP/ENTER key.

Explanation

Actions that can be assigned

Enclosed in parentheses are soft key expressions.

- **None:** [None]
No action is assigned.

10.9 Setting the Remote Control Functions (/R1 Option, Basic Setting Mode)

- **Starts/stops data acquisition: [StartStop]**
 - Remote input: Rising/start, falling/stop
 - Start
Starts/stops the acquisition of the display data and the event data, and the report (option).
 - Stop
Stops the acquisition of the display data and the event data, and the report (option).
 - If the data acquisition is in progress, applying a rising signal produces no effect. If the data acquisition is stopped, applying a falling signal produces no effect.
- **External trigger for event data acquisition: [Trigger]**
 - Remote input: Trigger, 250 ms or more
 - This becomes the external trigger that starts the acquisition of the event data to the internal memory. This is valid only when acquiring the event data to the internal memory using the trigger or rotate mode, the acquisition start trigger is set to external trigger, and the DX100L is in the trigger wait state (see section 8.2). For all other cases, applying the remote signal produces no effect.
- **Releasing the alarm indication and output relay: [AlarmACK]**
 - Remote input: Trigger, 250 ms or more
 - Releases the alarm indication and relay output (option). This is the same function as when the [AlarmACK] soft key is pressed.
- **Adjusting the internal clock: [Time adj]**
 - Remote input: Trigger, 250 ms or more
 - Adjusts the internal clock of the DX100L to the nearest hour depending on the time when the remote signal is applied.

Time of signal input	New time
00 min. 00 s to 01 min. 59 s	Adjusts the internal clock down to the nearest hour. Example: 10 hr. 01 min. 50 s becomes 10 hr. 00 min. 00 s.
02 min. 00 s to 57 min. 59 s	Time is unchanged.
58 min. 00 s to 59 min. 59 s	Adjusts the internal clock down to the nearest hour. Example: 10 hr. 59 min. 50 s becomes 11 hr. 00 min. 00 s.

- **Starts/stops computation (option): [Math]**
 - Remote input: Rising/start, falling/stop
 - Starts/stops the computation. This is valid only on models with the computation function (/M1 option).
 - If the computation is started, applying a rising signal produces no effect. If the computation is stopped, applying a falling signal produces no effect.
- **Clears computed results (option): [Math rst]**
 - Remote input: Trigger, 250 ms or more
 - Resets the data on all computation channels. This is valid only on models with the computation function (/M1 option) and while the computation is stopped. For all other cases, applying the remote signal produces no effect.
- **Manual sampling: [M.sample]**
 - Remote input: Trigger, 250 ms or more
 - The instantaneous values of all measurement and computation channels (excluding the measurement channels that are set to [Skip] and the computation channels that are turned Off) can be stored to the internal memory.

- **Loads the setup data: [Pnl1 load] [Pnl2 load] [Pnl3 load]**
 - Remote input: Trigger, 250 ms or more
 - The setup data of the file “LOAD 1.PNL,” “LOAD 2.PNL,” or “LOAD 3.PNL” that is saved in the external storage medium are loaded for use. The file, “LOAD 1.PNL,” “LOAD 2.PNL,” or “LOAD 3.PNL” must be created and saved to the external storage medium beforehand.
- **Writing messages: [Message1] to [Message8]**
 - Remote input: Trigger, 250 ms or more
 - Displays a message at the position corresponding to the time when the signal was applied on the trend screen. The displayed message is also written to the internal memory. When the data acquisition to the internal memory is stopped, messages cannot be displayed or written. Applying a remote signal produces no effect.
- **Snapshot: [Snapshot]**
 - Remote input signal: Trigger, 250 ms or more
 - Saves the current screen image data to the external storage medium. The snapshot function operates in all modes (operation mode, setting mode, and basic setting mode). Error messages, even if they are displayed, are not saved.

Remote input signal

The above operations are carried out on the rising or falling edge of the remote signal (edge) or the ON signal lasting at least 250 ms (trigger).

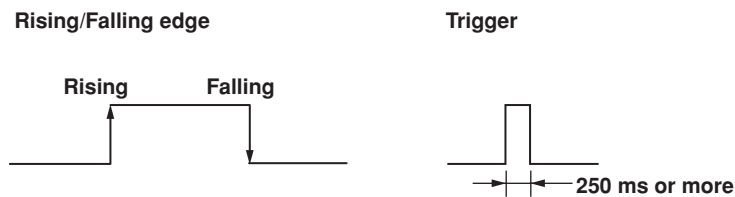

For contact inputs, the remote signal rises when the contact switches from open to closed and falls when the contact switches from closed to open. For open collector signals, the remote signal rises when the collector signal (voltage level of the remote terminal) goes from high to low and falls when the collector signal goes low to high.

10.10 Setting the Displayed Language (Basic Setting Mode)

Select the language that is used on the screen. The initial setting is English.

Procedure

- These procedures are carried out in the basic setting mode.
- Use the arrow keys to move the cursor (blue) to the appropriate parameter.
- The possible selections are displayed at the bottom of the screen. Select using the soft keys.
- The parameter boxes that are changed are displayed in yellow. By confirming the new settings, they change back to white.

Press .

Press  for 3 seconds. The menu screen for the basic setting mode appears.

Press the soft key .

To display the setting screen press the soft key .

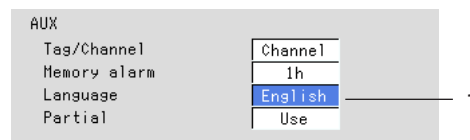

The numbers in front of the operating procedure shown below correspond to the numbers in the above figure.

1. Aux - Language
Select the language.

Confirming operation

To confirm the new settings, press the DISP/ENTER key.

To cancel the new settings, press the ESC key. A window appears for you to confirm the cancellation. Select [Yes] using the arrow keys and press the DISP/ENTER key.

10.11 Checking or Changing Batch/Lot Numbers and Entering or Changing Comments (/BT1 Option)

The batch number and lot number can be checked or changed on the batch screen. You can also enter comments.

Procedure

These procedures are carried out in the operation mode.

Opening the batch screen

1. Press the FUNC key to display the soft key menu.
2. Press the [Batch] soft key to display the batch screen.

The screenshot shows a terminal-style interface with the following fields and callouts:

- 3**: Points to the 'Batch name-No.' field, which contains 'SAMPLE' and a cursor.
- 4**: Points to the 'Lot' field, which contains '15'.
- 5**: Points to the 'Comment' section, which has three numbered input lines (1, 2, 3).

Other visible text on the screen includes:
Application name : AP
Supervisor name : SUPERVISOR
Manager name : MANAGER

The numbers in front of the operating procedure shown below correspond to the numbers in the above figure.

Change the batch number (up to 16 characters)

Cannot be changed while data are being acquired to the internal memory.

3. Use the arrow keys to move the cursor (blue) to the batch number box. Pressing the [Input] soft key displays a window used to enter the batch number. The current batch number is displayed. Change it and press the DISP/ENTER key. The batch number is confirmed and the screen returns to the batch screen. Procedures related to entering character strings, see “Entering Characters” on page 3-22.

Changing the lot number (up to 4 numerical digits)

Cannot be changed while data are being acquired to the internal memory.

4. Use the arrow keys to move the cursor (blue) to the lot number box. Pressing the [Input] soft key displays a window used to enter the lot number. The current lot number is displayed. Change the number and press the DISP/ENTER key. The lot number is confirmed and the screen returns to the batch screen. Procedures related to entering numerical values, see “Entering Numbers” on page 3-21.

10.11 Checking or Changing Batch/Lot Numbers and Entering or Changing Comments (/BT1 Option)

Entering comments (up to 32 characters x 3 lines)

The comment, the name of the user that entered the comment (only when the key login function is enabled), and the date and time when the comment was entered are written to the internal memory along with the measured/computed data. The comment is cleared when the data acquisition to the internal memory is stopped.

5. Use the arrow keys to move the cursor to the first line in the comment box. Pressing the [Input] soft key displays a window used to enter the comment. Enter the comment and press the DISP/ENTER key. The comment is confirmed and the screen returns to the batch screen. Enter comments in the second and third lines in the similar fashion. Procedures related to entering character strings, see "Entering Characters" on page 3-22.

The date and time at which the DISP/ENTER key is pressed after entering the last comment is written to the internal memory as the date and time when the comment was entered.

Note

- You can enter the comment once while data acquisition is in progress. However, if you had entered a comment before you started data acquisition, you cannot reenter the comment while data acquisition is in progress.
 - Comments are not saved to the setup file.
-

Clearing the batch screen

Press the DISP/ENTER key or the ESC key to close the batch screen.

10.12 Setting the Batch Information (/BT1 Option)

You can set the following items that are attached to the data acquired in the internal memory.

- Application name
- Supervisor name
- Manager name
- Batch number
- Lot number

In addition you can set whether or not to use the following functions:

- Automatically increment the lot number at the end of the batch.
- Display the batch number and lot number for each file in place of the date and time the data acquisition ended, on the memory summary screen.

Procedure

- These procedures are carried out in the setting mode.
- Use the arrow keys to move the cursor (blue) to the appropriate position. (The parameters that cannot be changed are grayed.)
- The possible selections are displayed at the bottom of the screen. Select using the soft keys.
- The parameter boxes that are changed are displayed in yellow. By confirming the new settings, they change back to white.

Press .

Twice press the soft key .

To display the setting screen press the soft key .

For models with the computation function, the soft key positions change. Operate as follows:

To display the setting screen press the soft key .

Batch		
Application name		1
Supervisor name		2
Manager name		3
Batch number		4
Lot number		5
Auto increment		6
Disp information		7

The numbers in front of the operating procedure shown below correspond to the numbers in the above figure.

1. Application name
Pressing the [Input] soft key displays a window used to enter the application name. Enter the application name (up to 16 characters), and press the DISP/ENTER key.
Procedures related to entering character strings, see “Entering Characters” on page 3-22.
2. Supervisor name
Enter the supervisor name (up to 16 characters) using the same method as step 1.

10.12 Setting the Batch Information (/BT1 Option)

3. Manager name
Enter the manager name (up to 16 characters) using the same method as step 1.
4. Batch number
Enter the batch number (up to 16 characters) using the same method as step 1.
5. Lot number
Pressing the [Input] soft key displays a window used to enter the lot number. Enter the lot number (0-9999), and press the DISP/ENTER key. Procedures related to entering numerical values, see “Entering Numbers” on page 3-21.
6. Auto increment (Automatic increment of the lot number)
Set whether or not to automatically increment the lot number (to the next lot number) when the data acquisition to the internal memory is complete.
[On]: Automatically increment the lot number when the data acquisition is complete.
[Off]: Do not change the lot number.

Note

The lot number after 9999 is 0.

7. Disp information (Displayed information of the stored data)
Set whether to display the batch number and lot number or the date and time of file creation on the memory summary, display data load, and event data load screens.
[Batch]: Display the batch number and lot number.
[Time]: Display the date and time of file creation.

Confirming operation

To confirm the new settings, press the DISP/ENTER key.

To cancel the new settings, press the ESC key. A window appears for you to confirm the cancellation. Select [Yes] using the arrow keys and press the DISP/ENTER key.

10.13 Setting Whether or Not to Use the Batch Function (/BT1 Option, Basic Setting Mode)

This setting is possible on models with the batch function. It is set in the basic setting mode.

Procedure

- These procedures are carried out in the basic setting mode.
- Use the arrow keys to move the cursor (blue) to the appropriate parameter.
- The possible selections are displayed at the bottom of the screen. Select using the soft keys.
- The parameter boxes that are changed are displayed in yellow. By confirming the new settings, they change back to white.

Press .

Press  for 3 seconds. The menu screen for the basic setting mode appears.

Press the soft key .

To display the setting screen press the soft key .

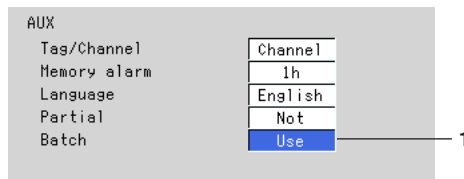

The numbers in front of the operating procedure shown below correspond to the numbers in the above figure.

1. Batch
[Use]: Use the batch function.
[Not]: Do not use the batch function.

Confirming operation

To confirm the new settings, press the DISP/ENTER key.

To cancel the new settings, press the ESC key. A window appears for you to confirm the cancellation. Select [Yes] using the arrow keys and press the DISP/ENTER key.

10.14 Using the Daylight Savings Time Adjustment Function

- When the specified time is reached at which the daylight savings time adjustment is to be enabled (the time set at [Summer]), the DX100L automatically sets the clock ahead by one hour.
(Example: If the time is set to 9 o'clock on June 1, the time is set ahead to 10 o'clock June 1.)
- When the specified time is reached at which the daylight savings time adjustment is to be disabled (the time set at [Winter]), the DX100L automatically sets the clock back by one hour.
(Example: If the time is set to 9 o'clock on December 1, the time is set back to 8 o'clock December 1.)
- The daylight savings time adjustment function is set using year, month, day, and time. Set the time for every year.
- The year is specified using the lower two digits. 00 to 79 represent year 2000 to 2079. 80 to 99 represent 1980 to 1999.

Procedure

Setting the time at which the daylight savings time adjustment is to be enabled/disabled

- These procedures are carried out in the setting mode.
- Use the arrow keys to move the cursor (blue) to the appropriate parameter. (The parameters that cannot be changed are grayed.)
- The possible selections are displayed at the bottom of the screen. Select using the soft keys.
- The parameter boxes that are changed are displayed in yellow. By confirming the new settings, they change back to white.

Press .

Press the soft key .

To display the setting screen press the soft key .

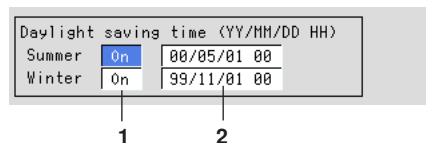

The numbers in front of the operating procedure shown below correspond to the numbers in the above figure.

1. On/Off
Select whether or not to use the daylight savings time adjustment function. If [On] is selected, a box used to enter the year, month, and day appears. If this parameter is set to [On] and the summer/winter time is set, this parameter turns [Off] automatically when the set time is elapsed.
2. Summer/Winter
Set the time at which the daylight savings time adjustment is to be enabled/disabled. Pressing the [Input] soft key displays a window used to enter the year, month, day, and time. Enter the values and press the DISP/ENTER key. For the procedures related to entering numerical values, see "Entering Numbers" on page 3-21.

10.14 Using the Daylight Savings Time Adjustment Function

Confirming operation

To confirm the new settings, press the DISP/ENTER key.

To cancel the new settings, press the ESC key. A window appears for you to confirm the cancellation. Select [Yes] using the arrow keys and press the DISP/ENTER key.

10.15 Setting the Temperature Unit (Basic Setting Mode)

Select the temperature unit from °C or °F.

Procedure

- These procedures are carried out in the basic setting mode.
- Use the arrow keys to move the cursor (blue) to the appropriate parameter.
- The possible selections are displayed at the bottom of the screen. Select using the soft keys.
- The parameter boxes that are changed are displayed in yellow. By confirming the new settings, they change back to white.

Press .

Press  for 3 seconds. The menu screen for the basic setting mode appears.

To display the setting screen press the soft key .



Temperature  1

The numbers in front of the operating procedure shown below correspond to the numbers in the above figure.

1. Temperature Unit
Select [C] or [F].
[C]: Celsius
[F]: Fahrenheit

Confirming operation

To confirm the new settings, press the DISP/ENTER key.

To cancel the new settings, press the ESC key. A window appears for you to confirm the cancellation. Select [Yes] using the arrow keys and press the DISP/ENTER key.

10.16 Setting the Time Zone (Basic Setting Mode)

Set the time difference from GMT (Greenwich mean time).

Procedure

- These procedures are carried out in the basic setting mode.
- Use the arrow keys to move the cursor (blue) to the appropriate parameter.
- The possible selections are displayed at the bottom of the screen. Select using the soft keys.
- The parameter boxes that are changed are displayed in yellow. By confirming the new settings, they change back to white.

Press .

Press  for 3 seconds. The menu screen for the basic setting mode appears.

Press the soft key .

To display the setting screen press the soft key .



The numbers in front of the operating procedure shown below correspond to the numbers in the above figure.

1. GMT

Pressing the [Input] soft key or one of the character/number input keys displays a window used to enter the time difference. Enter the value (-1200 to 1200 (upper two digits: hours, lower two digits: minutes)) and press the DISP/ENTER key. For the procedures related to entering numerical values, see "Entering Numbers" on page 3-21.

Example: If the local time leads 9 hours to GMT, set "900".

Confirming operation

To confirm the new settings, press the DISP/ENTER key.

To cancel the new settings, press the ESC key. A window appears for you to confirm the cancellation. Select [Yes] using the arrow keys and press the DISP/ENTER key.

11.1 Overview of the Computation Function

Equations can be written to computation channels by using the measured data or computed data as variables. The result of the computation can be displayed or stored. Computation is performed every scan interval. In addition, a moving average (“rolling average”) can be calculated on the computed result, and the moving average value can be used as the computed data for that channel. For report functions, see sections 11.11 to 11.13.

Computation channels

Model	Channels
DX102L	Channel 31 to 34 (4 channels)
DX104L	Channel 31 to 34 (4 channels)
DX106L	Channel 31 to 42 (12 channels)
DX112L	Channel 31 to 42 (12 channels)

Types of computations

In the table below, y represents the computed result. X and n generally represent the measured data and a constant. For details, see “Data that can be used in equations.”

Type	Description
Four arithmetical operations	Addition (+), subtraction (–), multiplication (×), and division (/)
**	Determines the power. $y = X^n$
SQR	Determines the square root.
ABS	Determines the absolute value.
LOG	Determines the common logarithm. $y = \log_{10}x$
EXP	Determines the exponent. $y = e^x$
Relational computation	Determines <, ≤, >, ≥, =, ≠ of two elements and outputs “0” or “1.”
Logical computation	Determines the AND (logical product), OR (logical sum), XOR (exclusive logical sum) of two elements, NOT (negation) of an element and outputs “0” or “1.”
Statistical computation (TLOG)	Determines the sum, maximum, minimum, average, and maximum – minimum (P–P) values at specified time intervals over the time interval. There are three timers used to set the time interval. For detail, see section 11.7.

Data that can be used in equations

For TLOG computation, only measured and computed data can be used. For all other computations, all types of data can be used.

Measured data

The data are specified using channel numbers in computing equations. If scaling is in effect, the scaled values are used in the computation.

Computed data

The data are specified using channel numbers in computing equations.

Constants (K01 to K12)

The values assigned to K01 to K12 can be used as constants. Enter the values as K01 to K12 in the equations.

Range of constants (Maximum number of significant digits is 5):

–9.9999E + 29 to –1.0000E – 30, 0, 1.0000E – 30 to 9.9999E + 29

11.1 Overview of the Computation Function

Communication input data (C01 to C12)

Data that have been specified through the communication interface can be used. Enter the data as C01 to C12 in the equations. For the procedure used to set the data, see the DX100/DX200 Communication Interface User's Manual (IM 04L02A01-17E).

Range of numerical values (Maximum number of significant digits is 5):
-9.9999E + 29 to -1.0000E - 30, 0, 1.0000E - 30 to 9.9999E + 29

Conditions of the remote control terminals (D01 to D08)

The conditions of the remote input signal can be assigned to "1" and "0," and used in the equations. Enter the data as D01 to D08 (the number following the letter D is the remote terminal number) in the equations.

The correlation between the conditions of the remote input signal and the value "1" and "0" are shown below.

Type of the remote input signal	Status	"1" or "0"
Contact	close	1
	open	0
Open collector	Voltage level is Lo at the remote terminal	1
	Voltage level is Hi at the remote terminal	0

Unit handling

The unit corresponding to the measured/computed data in the equation is not compensated. In computations, measured and computed data are handled as values without units. For example, if the measured data from channel 01 is 20 mV and the measured data from channel 02 is 20 V, the computed result of 01 + 02 is 40.

Order of precedence of the operators

The order of precedence of the operators in the equation is as follows. The operators are placed in order from the highest precedence.

Type	Operator
	(higher precedence)
Functions	ABS(), SQR(), LOG(), EXP(), TLOG.MAX(), TLOG.MIN(), TLOG.P-P(), TLOG.SUM(), TLOG.AVE()
Power	**
Logical negation	NOT
Multiplication and division	*, /
Addition and subtraction	+, -
Greater than/less than	.GT., .LT., .GE., .LE.
Equal/not equal	.EQ., .NE.
Logical AND	AND
Logical OR, exclusive OR	OR, XOR
	(lower precedence)

Displaying the computed result

The computed data of computation channels can be displayed in each operation screen.

Displaying the waveform and bar graph

The data are displayed in the range defined by the upper and lower limits of the span.

For the settings related to displaying the computed result, see sections below.

Set computation channels:	See section 11.4.
Assign channels to groups:	See section 7.6.
Display tags:	See sections 7.1 and 7.2.
Set the channel display color:	See section 7.8.
Use zone display:	See section 7.9.
Set the number of scale divisions:	See section 7.10.

Set the base position of the bar graph: See section 7.10.
 Specify the scale display position: See section 7.10.
 Use partial expanded display: See sections 7.11 and 7.12.

Numerical display

The range of displayed values of computed data is from –9999999 to 99999999 excluding the decimal point. The decimal point position corresponds to the position of the decimal point of the upper and lower limit span of the computation channel. However, special displays are used for cases given in the table below.

Data Condition	Computation	Display
The computed result exceeds 99999999.	positive over display range	+*****
The computed result is below –9999999.	negative over display range	–*****
The value exceeds 3.4E + 38, or is below –3.4E + 38 in the middle of computation.	overflow	+***** or –*****
An error is detected. When the following computation is specified, a computation error occurs.	error	+*****
<ul style="list-style-type: none"> • X/0 • SQR (–X) • LOG (–X) • When a skipped channel No. is entered in the equation. 		
The number of stacks (see section 11.2) in the equation exceeds 17.	error	+*****

Rolling average

The moving average of the computed result of the equation specified for the computation channel is determined, and the result is displayed as computed data for that channel. The sampling interval and the number of samples can be specified for each channel. The maximum sampling interval is 1 hour; the maximum number of samples is 64. The initial setting is [OFF] (do not perform moving average). For the setting procedure, see section 11.10.

Alarm

You can set up to 4 alarms on each computation channel. The alarm types are upper limit alarm (H), lower limit alarm (L), delay upper limit alarm (T), and delay lower limit alarm (t). The hysteresis is fixed to 0. For the procedures to set the alarms, see section 11.5. For the alarm indication, see sections 4.2 and 6.1.

Acquiring the computed data

Display data and event data

The computed data from the computation channels can be acquired as the display data and event data in the same manner as for the measurement channels. See chapter 8.

Manual sampled data

The instantaneous values of all computation channels (excluding the computation channels that are turned Off) can be stored to the internal memory with the manual sampling operation. For the operating procedure, see section 8.12.

TLOG data

The TLOG data are acquired every interval. For the setting procedure, see section 11.9.

Setting computation channels

The computation channel specifications are set in the setting mode. For detail, see sections 11.4 through 11.6.

The timer used in the TLOG computation is set in the basic setting mode. For detail, see section 11.9.

11.2 Explanation of Computing Equations

This section describes the meaning of the computation equation and how to write them.

Four arithmetical computations

The types of data that can be used in equations are measured data, computed data, constants (K01 to K12), communication interface data (C01 to C12), and the remote control terminal conditions (D01 to D08).

EXAMPLE:

Addition (+): 01+02

Computes the measured value of channel 1 plus the measured value of channel 2

Subtraction (-): 01-02

Computes the measured value of channel 1 minus the measured value of channel 2

Multiplication (*): 01*K03

Computes the measured value of channel 1 multiplied by constant K03

Division (/): 01/K02

Computes the measured value of channel 1 divided by constant K02

Note

When you set an expression as e.g. 31 + 01 on channel 31, the summation of channel number 1 will be displayed in channel 31.

Power, SQR, ABS, LOG, EXP Computations

The types of data that can be used in equations are measured data, computed data, constants (K01 to K12), communication interface data (C01 to C12), and the remote control terminal conditions (D01 to D08). You can nest a computing element inside the parentheses of another computing element.

EXAMPLE:

Power (**): 01**02

Raises measured value of channel 1 to the power of measured value of channel 2

Square root (SQR): SQR (01)

Returns the square root of the measured value of channel 1

Absolute value (ABS): ABS (01)

Returns the absolute value of the measured value of channel 1

Logarithm (LOG): LOG (01)

Returns the common logarithm of the measured value of channel 1

Exponent (EXP): EXP (01)

Raises e to the power of the measured value of channel 1

Note

The natural logarithm is not directly provided, but can be obtained by using the following:
 $\log_e x = \log_{10} x / \log_{10} e$ as $\log_b x = \log_a x / \log_a b$
Therefore, to calculate the natural logarithm of the value of channel 01, set K01 = 1.
Then the expression will become: LOG (01)/LOG (EXP(K01))

Relational Computation

The types of data that can be used in equations are measured data, computed data, constants (K01 to K12), communication interface data (C01 to C12), and the remote control terminal conditions (D01 to D08). You can specify a computing equation that performs relational computation on a computing element (Example: 01.LT.ABS(02)).

EXAMPLE:

02.LT.03

The computed result will be "1" if the measured value of channel 2 is less than the measured value in channel 3, otherwise the value will be "0."

02.GT.03

The computed result will be "1" if the measured value of channel 2 is greater than the measured value in channel 3, otherwise the value will be "0."

02.EQ.03

The computed result will be "1" if the measured value of channel 2 is equal to the measured value in channel 3, otherwise the value will be "0."

02.NE.03

The computed result will be "1" if the measured value of channel 2 is not equal to the measured value in channel 3, otherwise the value will be "0."

02.GE.03

The computed result will be "1" if the measured value of channel 2 is greater than or equal to the measured value in channel 3, otherwise the value will be "0."

02.LE.03

The computed result will be "1" if the measured value of channel 2 is less than or equal to the measured value in channel 3, otherwise the value will be "0."

Logical Computation

The computation is performed using e1 and e2 which are identified as either "zero" or "non zero". The types of data that can be used in equations are measured data, computed data, constants (K01 to K12), communication interface data (C01 to C12), and the remote control terminal conditions (D01 to D08). You can specify a computing equation that performs logical computation on a computing element.

AND Logical product

Syntax: e1ANDe2

Condition: If both e1 and e2 are "non 0", the operation results in "1", otherwise in "0."

Status: e1 = 0, e2 = 0
e1ANDe2 = 0

e1 ≠ 0, e2 = 0
e1ANDe2 = 0

e1 = 0, e2 ≠ 0
e1ANDe2 = 0

e1 ≠ 0, e2 ≠ 0
e1ANDe2 = 1

11.2 Explanation of Computing Equations

OR Logical sum

Syntax: $e1ORe2$

Condition: If both $e1$ and $e2$ are "0", the operation results in "0", otherwise in "1."

Status: $e1 = 0, e2 = 0$
 $e1ORe2 = 0$

$e1 \neq 0, e2 = 0$
 $e1ORe2 = 1$

$e1 = 0, e2 \neq 0$
 $e1ORe2 = 1$

$e1 \neq 0, e2 \neq 0$
 $e1ORe2 = 1$

XOR Mutually exclusive logical sum

Syntax: $e1XORe2$

Condition: If $e1$ and $e2$ have different values, the operation results in "1", otherwise in "0."

Status: $e1 = 0, e2 = 0$
 $e1XORe2 = 0$

$e1 \neq 0, e2 = 0$
 $e1XORe2 = 1$

$e1 = 0, e2 \neq 0$
 $e1XORe2 = 1$

$e1 \neq 0, e2 \neq 0$
 $e1XORe2 = 0$

NOT Logical negation

Syntax: $NOTe1$

Condition: Reverses the value of data $e1$

Status: $e1 = 0 \quad NOTe1 = 1$
 $e1 \neq 0 \quad NOTe1 = 0$

EXAMPLE:

01-02OR03.GT.04

Determines the OR of the computed results of "01-02" and "03.GT.04."

TLOG Computation (MAX, MIN, AVE, SUM, MAX-MIN)

Only measured data and computed data can be used in the TLOG computation. In the explanation below, e1 is used to represent a measurement or computation channel. You cannot specify an equation that contains a computing element inside e1. In addition, only one TLOG computation can be specified in a single computing equation.

TLOG.MAX ()

Syntax: TLOG.MAX (e1)

Result: Computes the maximum value of channel e1

TLOG.MIN ()

Syntax: TLOG.MIN (e1)

Result: Computes the minimum value of channel e1

TLOG.AVE ()

Syntax: TLOG.AVE (e1)

Result: Computes the average value of channel e1

TLOG.SUM ()

Syntax: TLOG.SUM (e1)

Result: Computes the summation of channel e1

TLOG.P-P ()

Syntax: TLOG.P-P (e1)

Result: Computes the maximum value – minimum value of channel e1

An example of computing equations

TLOG.MAX(01)+K01*SQR(02)

Examples of computing equations that are not allowed

TLOG.AVE(01)+TLOG.AVE(02)

Reason: TLOG appears twice in one equation.

TLOG.AVE(ABS(01))

Reason: A computing element is used inside the parentheses.

Rules for writing an equation (common items)

Follow the rules below in writing the computing equations.

- Use up to 40 characters to write equations.
- The precedence of computing terms can be specified using parentheses.
- Specify the channels in the equation using channel numbers. (Example: Channel 1 is "01" or "1")
- You can use "01" or "1," for example, to specify one-digit numbers for channels, constants, communication input data, and conditions of the remote control terminals in equations.
Example: 01, 1, K01, K1, C01, C1, D01, D1
- The data value for the channel used in the equation, and for all channels greater in number than that channel, are substituted with data from the previous scan.
- Do not use more than 16 stacks (channel, K01 to K12, C01 to C12, D01 to D08) in one equation. Otherwise, a computation error may occur. The computed result is set to positive overflow (displayed as +******) in this case.
Example: The number of stacks in the equation 01+K01*(03+04*K02) is five.

11.3 Using the Computation Function

Operations related to the computation function are as follows:

- Start/stop computation.
This operation can be carried out with the START/STOP key, the FUNC key, or the USER key (when [Math] is assigned).
- Reset computation data.
This operation can be carried out with the FUNC key, or the USER key (when [Math rst] is assigned).
- Release the computation data dropout display.
This operation is carried out with the FUNC key.

Start/stop computation

Procedure

Operation using the START/STOP key

- **Starting the computation (also starts the data acquisition to the internal memory)**
 1. Press the START key to start the computation. At this point, the data acquisition to the internal memory is also started. When the computation is started, a computation icon is displayed in the status display section. For details related to the status display section, see section 4.2.
- **Stopping the computation (also stops the data acquisition to the internal memory)**
 1. Press the STOP key. A confirmation window is displayed. For models with the batch function (/BT1 option), the batch information is also displayed.
 2. Use the arrow keys to select [Mem + Math] and press DISP/ENTER to stop the computation. At this point, the data acquisition to the internal memory is also stopped. The computation icon in the status display section also disappears.

Operation using the FUNC key

1. Press the FUNC key to display the soft key menu.
When the computation is suspended the [Math START] soft key is displayed. If the computation is in progress the [Math STOP] soft key is displayed.
- **Starting the computation**
 2. Press the [Math START] key to start the computation. When the computation is started, a computation icon is displayed in the status display section. For details related to the status display section, see section 4.2.



- **Stopping the computation**
 2. Press the [Math STOP] key to stop the computation. The computation icon in the status display section disappears.

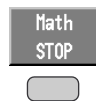

Operation using the USER key

The operation is for when the start/stop function of computation is assigned to the USER key.

- **Starting the computation**

1. Press the USER key to start the computation. When the computation is started, a computation icon is displayed in the status display section. For details related to the status display section, see section 4.2.

- **Stopping the computation**

1. Press the USER key to stop the computation. The computation icon in the status display section disappears.

Note

When the computation is stopped, the computed data of the computation channel is held at the value that existed immediately before. If data are being written to the internal memory, the value held is written.

Resetting the computation

This is executable only when the computation is suspended. Data from all computation channels are cleared.

Procedure**Operation using the FUNC key**

1. Pressing the FUNC key displays the soft key menu.
The [Math RESET] soft key is displayed only when the computation is suspended.
2. Pressing the [Math RESET] soft key clears the data from all computation channels.

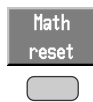
**Operation using the USER key**

The operation is for when the reset function of computation is assigned to the USER key.

1. Press the USER key to reset the computation data of all computation channels.

Clearing the computation dropout display

When a computation data dropout occurs during computation, the computation icon displayed in the status display section turns yellow. The computation icon will return to a white color once the computation data dropout has been acknowledged.

Computation icon**Procedure**

1. Pressing the FUNC key displays the soft key menu.
The [Math ACK] soft key is displayed only when a computation data dropout occurs.
2. Pressing the [Math ACK] soft key causes the yellow computation icon in the status display section to return to a white color.

Explanation

Computation data dropout occurs when the computation is not completed within the scan interval. When this occurs frequently, lower the CPU load by reducing the number of computation channels or making the scan interval longer. When computation data are acquired to the internal memory, the data immediately before a computation drop out are substituted for the computation data at the time of the dropout.

11.4 Setting Computation Channels

This section describes the procedures to set equations to computation channels. The equation is set in the setting mode. Equations cannot be set while data acquisition or computation is in progress.

Procedure

- These procedures are carried out in the setting mode.
- Use the arrow keys to move the cursor (blue) to the appropriate parameter. (The parameters that cannot be changed are grayed).
- The possible selections are displayed at the bottom of the screen. Select using the soft keys.
- The parameter boxes that are changed are displayed in yellow. By confirming the new settings, they change back to white.

Press .

Twice press the soft key .

To display the setting screen press the soft key .

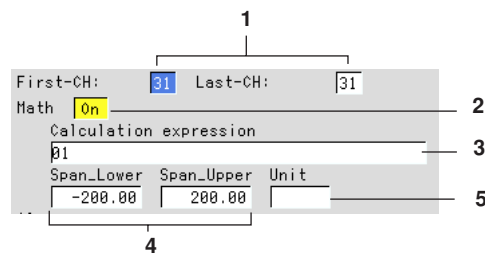

The numbers in front of the operating procedure shown below correspond to the numbers in the above figure.

1. First channel and last channel
Select the desired channels.
2. Math On/Off
If [On] is selected a box for the equation will appear. When not using computation, select [Off].
3. Calculation expression
Enter the equation (up to 40 characters).
Pressing the [Input] soft key displays a window used to enter an equation. Enter the equation using the following key operations and press the DISP/ENTER key. For writing equations, see "Rules for writing an equation (common items)" in section 11.2.

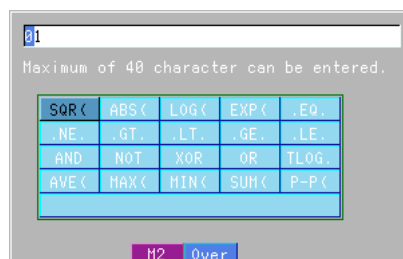

- **Left and right arrow key:** Select the input position.
- **Up and down arrow key:** Select the input character.
Use the [M1/M2] soft key to switch the function of the window between number input and computing element input.
- **[M1/M2] soft key:** Each time the [M1/M2] soft key is pressed the function of the window switches between number input and computing element input. The selected function is displayed to the bottom of the window.
[M1]: Number is selected.
[M2]: Computing element is selected.
- **[Del] soft key:** Delete the character at the cursor position.
- **[Bs] soft key:** Delete the character before the cursor position.
- **[Ins] soft key:** Switch between insert and overwrite.
Each time the [Ins] soft key is pressed insert and overwrite switches. The selected function is displayed to the bottom of the window.
[Over]: Overwrites the cursor position.
[Ins]: Inserts at the cursor position.

Note

When using TLOG computation, timers must be set in the basic setting mode and the number of the timer and the sum unit (only for TLOG.SUM) must be set in the setting mode.

4. Upper and lower limits of span
Set the upper and lower limits of the display span.
Pressing the [Input] soft key displays a window used to enter a numerical value.
Enter a value in the allowed range given below and press the DISP/ENTER key.
For the procedures related to entering numerical values, see “Entering Numbers” on page 3-21.
Allowed range: -9999999 to 99999999
The decimal can be set in the following positions:
“□.□□□□” “□□.□□□□” “□□□.□□□□” “□□□□.□□□□” “□□□□□□□□”

Note

The upper and lower limits of span cannot be set to the same value.

5. Unit
Set the unit
Pressing the [Input] soft key displays a window used to enter a character string.
Enter the unit (up to 6 alphanumeric characters) and press the DISP/ENTER key. For the procedures related to entering character strings, see “Entering Characters” on page 3-22.

Confirming operation

To confirm the new settings, press the DISP/ENTER key.

To cancel the new settings, press the ESC key. A window appears for you to confirm the cancellation. Select [Yes] using the arrow keys and press the DISP/ENTER key.

Note

When computation is turned On/Off or when equations and span settings are changed, the alarm setting for that channel is turned OFF.

11.5 Setting the Alarm

You can set up to 4 alarms on each computation channel. The alarm types are upper limit alarm (H), lower limit alarm (L), delay upper limit alarm (T), and delay lower limit alarm (t). The hysteresis is fixed to 0.

Note

When [Math On/Off] is turned ON, an entry box used to enter the equation is displayed and the alarm setting boxes are activated (white color). Set the alarm after setting the equation. When computation is turned On/Off or when equations and span settings are changed, the alarm setting for that channel is turned OFF.

Procedure

- These procedures are carried out in the setting mode.
- Use the arrow keys to move the cursor (blue) to the appropriate parameter. (The parameters that cannot be changed are grayed).
- The possible selections are displayed at the bottom of the screen. Select using the soft keys.
- The parameter boxes that are changed are displayed in yellow. By confirming the new settings, they change back to white.

Press .

Twice press the soft key .

To display the setting screen press the soft key .

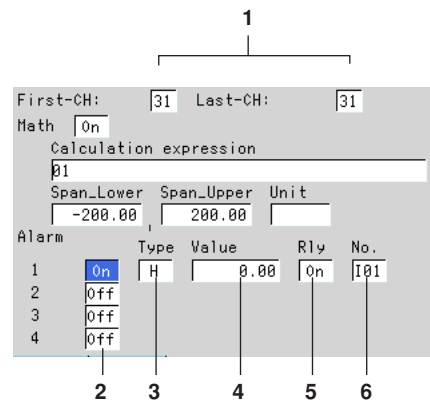

The numbers in front of the operating procedure shown below correspond to the numbers in the above figure.

1. First channel and last channel
Select the desired channels. (For the channels set here, the [Math] is also simultaneously set.)
2. On/Off
Turn the alarm On (enabled). Items 3, 4 and 5 are displayed.
[On]: Use alarm
[Off]: Do not use alarm

3. Type
Set the alarm type.
[H]: Upper limit alarm
[L]: Lower limit alarm
[T]: Delay upper limit alarm
[t]: Delay lower limit alarm

Note

If you select delay alarm (T or t) for the alarm type, you must set the alarm delay period. See section 6.3.

4. Value
Set the value at which the alarm is activated.
Pressing the [Input] soft key displays a window used to enter a numerical value.
Enter a value and press the DISP/ENTER key. For the procedures related to entering numerical values, see "Entering Numbers" on page 3-21.
- 5.* Rly (Relay)
Set whether or not to activate the relay output. If [On] is selected, output relay [Number] is displayed.
- 6.* Number
Set the output relay number.
For the correspondence between the output relay number and the output relay position, see section 2.4.

* If the alarm output relay option (/AR1, /AR2, or /A3) is not installed, this setting is void.

Confirming operation

To confirm the new settings, press the DISP/ENTER key.

To cancel the new settings, press the ESC key. A window appears for you to confirm the cancellation. Select [Yes] using the arrow keys and press the DISP/ENTER key.

Explanation**Alarm type**

Four types of alarms are available.

Name	Symbol	Description
Upper limit alarm	H	An alarm occurs when the measured value becomes greater than or equal to the alarm value.
Lower limit alarm	L	An alarm occurs when the measured value becomes smaller than or equal to the alarm value.
Delay upper limit alarm	T	An alarm occurs when the measured value remains above or equal to the alarm value for the specified time period (delay period, see section 6.3, "Setting the Alarm Delay Period.").
Delay lower limit alarm	t	An alarm occurs when the measured value remains below or equal to the alarm value for the specified time period (delay period, see section 6.3, "Setting the Alarm Delay Period.").

11.6 Setting Constants

Total of 12 constants (K01 to K12) can be defined.

Procedure

- These procedures are carried out in the setting mode.
- Use the arrow keys to move the cursor (blue) to the appropriate parameter. (The parameters that cannot be changed are grayed).
- The possible selections are displayed at the bottom of the screen. Select using the soft keys.
- The parameter boxes that are changed are displayed in yellow. By confirming the new settings, they change back to white.

Press .

Twice press the soft key .

To display the setting screen press the soft key .

1

Constant	
K01: 1	K07: 1
K02: 1	K08: 1
K03: 1	K09: 1
K04: 1	K10: 1
K05: 1	K11: 1
K06: 1	K12: 1

The numbers in front of the operating procedure shown below correspond to the numbers in the above figure.

1. Constant

Select the constant you wish to set using the arrow keys.

Pressing the [Input] soft key displays a window used to enter a numerical value. Enter a value in the allowed range and press the DISP/ENTER key. For the procedures related to entering numerical values, see “Entering Numbers” on page 3-21.

[E], [+]: Used when setting numbers with exponents.

Example: 5.0E+12

Confirming operation

To confirm the new settings, press the DISP/ENTER key.

To cancel the new settings, press the ESC key. A window appears for you to confirm the cancellation. Select [Yes] using the arrow keys and press the DISP/ENTER key.

Explanation

The number of significant digits is 5 excluding the decimal. When using exponents to set values, use 5 or less digits for the mantissa and two digits for the exponent.

The allowed range is as follows.

–9.9999E + 29 to –1.0000E – 30, 0, 1.0000E – 30 to 9.9999E + 29

11.7 TLOG Computation

Determines the sum, maximum, minimum, average, and maximum – minimum (P–P) values of the specified channel at specified time intervals. The interval is set by timers. The example shown in the following figure indicates the case in which the average value of channel 1 over each interval, TLOG.AVE(01), is determined.

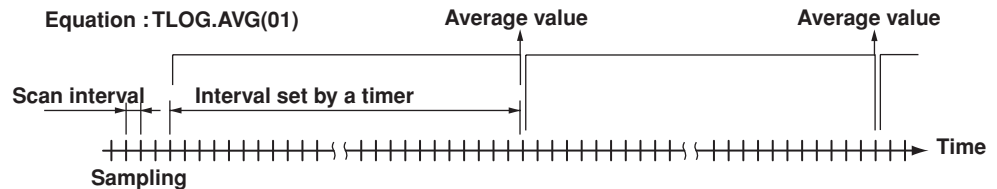

TLOG computation cannot be performed when the corresponding measurement channel is set to [Skip] or the corresponding computation channel is turned Off.

Timer Mode and Action

Timer mode

There are two timer modes: absolute mode and relative mode.

- **Absolute mode**

Timer expires at times determined from the reference time and the interval. The reference time is specified by the hour (00 to 23).

Example 1: Reference time: 14:00

Interval: 12 h

The expiration time is set to 2:00 (2:00 AM) and 14:00 (2:00 PM).

Example 2: Reference time: 00:00

Interval: 10 min

The expiration time is set to 0:00, 0:10, 0:20, ..., 23:40, and 23:50. For example, if the computation is started at 9:36, the time expiration will occur at 09:40, 09:50, 10:00, and so on.

- **Relative mode**

The timer is started when the computation is started. The timer is repeated at each interval. The timer is suspended while the power is lost.

Example: Interval: 00:15

The timer expires every 15 minutes after the computation is started.

Setting timers

Timers are set in the basic setting mode. For detail, see section 11.9.

Setting the timer No. for TLOG computation

The number of the timer used by the channel computing the TLOG is selected from 1, 2, and 3 in the setting mode. For the setting procedure, see section 11.8.

About the sum scale of the TLOG.SUM

In the sum computation (TLOG.SUM) of time series, data are summed over the scan interval. However, for flow values that have units /s, /min, or /h, a simple summation results in the actual value not matching the computed result, because the scan interval and the unit of the input values are different. In these cases, the unit of the data measured over the scan interval is converted to match the unit of the input values and the computation is performed.

11.7 TLOG Computation

For example, if the scan interval is 2 s, and the input value is 100 m³/min, a simple summation would add 100 every 2 s resulting in 3000 after one minute. However, if the computing unit is set to /min, then 2 s/60 s is multiplied every scan interval before the value is added giving a result that has a m³/min unit. The following equations are applied. The scan interval unit is in seconds.

Off $\sum(\text{measured value})$

/s $\sum(\text{measured value}) \times \text{scan interval}$

/min $\sum(\text{measured value}) \times \text{scan interval}/60$

/h $\sum(\text{measured value}) \times \text{scan interval}/3600$

For the setting procedure, see section 11.8.

About [Reset]

Whether or not to reset the computed result at every timeout is selectable. The figure below shows the action of TLOG.SUM computation.

Example: Result of the TLOG.SUM computation

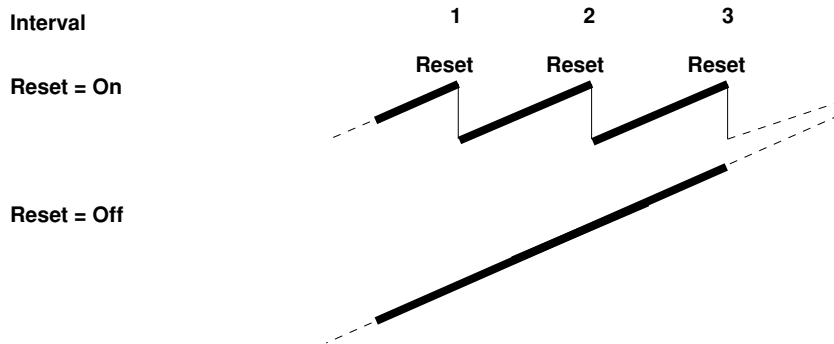

In case of TLOG.MAX computation, for example, the maximum value is derived for every interval when "Reset" is "On," and the maximum value from the start of computation is derived when "Reset" is "Off."

If power is lost while the TLOG computation was in progress

The TLOG computation is resumed when the power is restored. The operation varies depending on whether power is restored before or after the scheduled time to create the TLOG data.

Time of Recovery	TLOG Computation Operation
After the time to create the TLOG data	TLOG data are created immediately when power is restored. The measured/computed data up to the time of the power disruption are used. At the next scheduled TLOG computation time, data will be used from the point in time after the power was restored.
Before the time to create the TLOG data	After power is restored, TLOG data are created at the normally scheduled time to perform the TLOG computation. All measured/computed data excluding the power disruption period are used.

How the measured/computed data are handled when there is an abnormality in the data

Type of Abnormal Data	Report Data		
	AVE	MAX/MIN/P-P	SUM
Positive over*	not used	used	not used
Negative over*	not used	used	not used
Error	not used	not used	not used

* "over range" for measurement channels or "computation overflow" for computation channels

11.8 Setting the Timer Number and Sum Scale for TLOG Computation

Set the number of the timer used by the channel computing the TLOG. Also, set the [sum scale] that is used when determining the sum in TLOG.SUM. These are set in the setting mode.

The timer specifications are set in the basic setting mode.

Procedure

- These procedures are carried out in the setting mode.
- Use the arrow keys to move the cursor (blue) to the appropriate parameter. (The parameters that cannot be changed are grayed).
- The possible selections are displayed at the bottom of the screen. Select using the soft keys.
- The parameter boxes that are changed are displayed in yellow. By confirming the new settings, they change back to white.

Press .

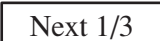
Twice press the soft key .

To display the setting screen press the soft key .

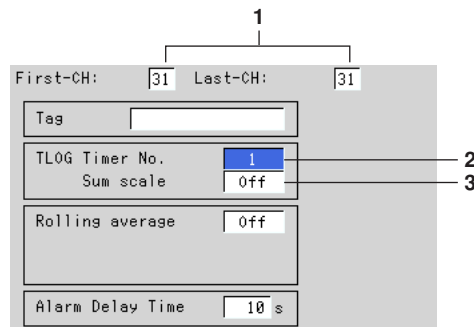

The numbers in front of the operating procedure shown below correspond to the numbers in the above figure.

1. First-CH and Last-CH
Select the desired channels. (For the channels set here, the [Tag], [Rolling average], and [Alarm Delay Time] are also simultaneously set.)
2. Timer No.
This is the timer specified in the basic setting mode. Select 1, 2, or 3.
3. Sum scale
When the channel is computing TLOG.SUM, select [Off], [s], [min], or [h]. The initial setting is [Off]. You do not have to set this for channels that are not computing TLOG.SUM (leave it [Off]).

Confirming operation

To confirm the new settings, press the DISP/ENTER key.

To cancel the new settings, press the ESC key. A window appears for you to confirm the cancellation. Select [Yes] using the arrow keys and press the DISP/ENTER key.

11.9 Setting the Timer (Basic Setting Mode)

Up to three timers can be specified. The timers specified here are used to determine the interval for the TLOG computation. In addition, all the data of measurement and computation channels can be stored at the interval determined by the timers.

Procedure

- These procedures are carried out in the basic setting mode.
- Use the arrow keys to move the cursor (blue) to the appropriate parameter.
- The possible selections are displayed at the bottom of the screen. Select using the soft keys.
- The parameter boxes that are changed are displayed in yellow. By confirming the new settings, they change back to white.

Press .

Press  for 3 seconds. The menu screen for the basic setting mode appears.

Twice press the soft key .

Press the soft key .

To display the setting screen press the soft key .

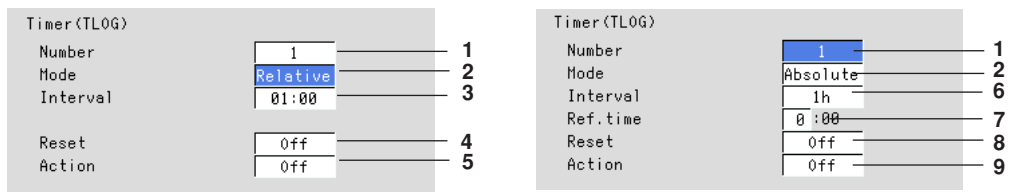

The numbers in front of the operating procedure shown below correspond to the numbers in the above figure.

1. Number
Select the desired timer number.

Setting the relative timer

2. Mode
Select [Relative]. [Interval], [Reset], and [Action] are displayed.
3. Interval
Set the time to the next timeout.
Pressing the [Input] soft key displays a window used to enter the time. Enter the time (00:01 to 24:00) and press the DISP/ENTER key. For the procedures related to entering numerical values, see "Entering Numbers" on page 3-21.
4. Reset
[On]: Reset the TLOG value when the timer expires.
[Off]: Do not reset the TLOG value when the timer expires.
5. Action
[DataSave]: Store the instantaneous values of all measurement/computation channels to the internal memory when the time expires.
[Off]: Do not store the measured/computed data.

Setting the absolute timer

2. Mode
Select [Absolute]. [Interval], [Reset], [Ref. time], and [Action] are displayed.
6. Interval
Set the time to the next timeout from 19 choices below.
1 min, 2 min, 3 min, 4 min, 5 min, 6 min, 10 min, 12 min, 15 min, 20 min, 30 min, 1 h, 2 h, 3 h, 4 h, 6 h, 8 h, 12 h, 24 h.
7. Ref. time
Pressing the [Input] soft key displays a window used to enter the time. Enter the time on the hour (00 to 23) and press the DISP/ENTER key. For the procedures related to entering numerical values, see “Entering Numbers” on page 3-21.
8. Reset
[On]: Reset the TLOG value when the timer expires.
[Off]: Do not reset the TLOG value when the timer expires.
9. Action
[DataSave]: Store the instantaneous values of all measurement/computation channels to the internal memory when the time expires.
[Off]: Do not store the measured/computed data.

Confirming operation

To confirm the new settings, press the DISP/ENTER key.

To cancel the new settings, press the ESC key. A window appears for you to confirm the cancellation. Select [Yes] using the arrow keys and press the DISP/ENTER key.

Explanation**Acquiring the data of all channels to the internal memory at each interval (setting at the [Action] box)**

If [Data Save] is specified in the [Action] box, the instantaneous values of every channel can be acquired to the internal memory at the specified interval.

When saving to the external storage medium, the data are saved to the TLOG data file (“DTG” extension). For details related to the data acquisition of data to the internal memory and the saving to the external storage medium, see the explanation on the TLOG data in chapter 8.

Note

TLOG data are stored to the internal memory at the interval determined by the timer when the timer is specified.

11.10 Using the Rolling Average

A rolling average can be specified as the moving average on the computed results of each computation channel. Set the sampling interval and the number of samples. The maximum sampling interval is 1 hour, the maximum number of samples is 64. The rolling average can be used to suppress fluctuations in the computed results.

Procedure

- These procedures are carried out in the setting mode.
- Use the arrow keys to move the cursor (blue) to the appropriate parameter. (The parameters that cannot be changed are grayed).
- The possible selections are displayed at the bottom of the screen. Select using the soft keys.
- The parameter boxes that are changed are displayed in yellow. By confirming the new settings, they change back to white.

Press .

Twice press the soft key .

To display the setting screen press the soft key .

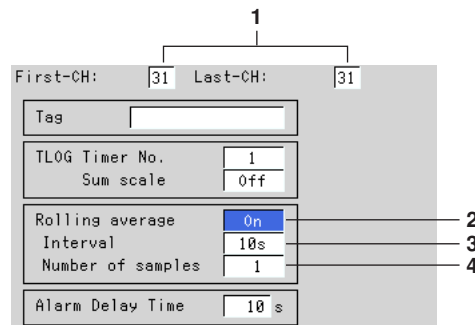

The numbers in front of the operating procedure shown below correspond to the numbers in the above figure.

1. First channel and last channel
Select the desired channels. (For the channels set here, the [Tag], [TLOG], and [Alarm Delay Time] are also simultaneously set.)
2. On/Off
[On]: Use rolling average
[Off]: Do not use rolling average
If [On] is selected, [Interval] and [Number of samples] are displayed.
3. Interval
Select the interval from the selections below. However, when the scan interval is set to 2 s, even if the sampling interval is set to 1 s, 3 s, 5 s, or 15 s, the sampling will be performed at 2 s, 4 s, 6 s, or 16 s.
1 s, 2 s, 3 s, 4 s, 5 s, 6 s, 10 s, 12 s, 15 s, 20 s, 30 s, 1 min, 2 min, 3 min, 4 min, 5 min, 6 min, 10 min, 12 min, 15 min, 20 min, 30 min, 1 h
4. Number of samples
This is the number of data points used to compute the rolling average. Set an integer value between 1 and 64.

Confirming operation

To confirm the new settings, press the DISP/ENTER key.

To cancel the new settings, press the ESC key. A window appears for you to confirm the cancellation. Select [Yes] using the arrow keys and press the DISP/ENTER key.

Explanation

- While the number of samples acquired is less than the specified number of samples, the average of acquired data is computed.
- The computation error data are not included in the rolling average computation.
- If the computed data exceeds the upper or lower limit, the data is clipped at the upper or lower limit, and the moving average is computed. The upper and lower limit is ± 100000000 excluding the decimal point. The decimal point position is the same as that of the specified value for the span lower limit.

11.11 Overview of the Report Function

This function is used to create hourly, daily, weekly, and monthly reports. The report data can be displayed on the screen. The report data are saved to the external storage medium in ASCII format. For data formats, see appendix 2, "Data Formats of ASCII Files."

Types of reports and specifications

Types of reports

- **Hourly report**

On every hour on the hour, the average, maximum, minimum, and sum values of the specified channels are determined from an hour of data up to the current hour and stored to the internal memory.

- **Daily report**

At the specified time everyday, the average, maximum, minimum, and sum values of the specified channels are determined from a day of data up to the specified time and stored to the internal memory.

- **Weekly report**

At the specified time of the specified day every week, the average, maximum, minimum, and sum values of the specified channels are determined from a week of data up to the specified time and stored to the internal memory.

- **Monthly report**

At the specified time of the specified date every month, the average, maximum, minimum, and sum values of the specified channels are determined from a month of data up to the specified time and stored to the internal memory.

Report data display

See section 4.5.

Combinations of reports that can be created

The reports created by the DX100L can be set to "hourly only," "daily only," "hourly and daily," "daily and weekly," or "daily and monthly."

Number of measurement and computation channels that can be assigned to the report

Up to 12 channels can be assigned to one report.

The report data are not created for channels that are set to [Skip] or those that have the computation turned [Off].

About the sum scale

In the sum computation, data are summed over the scan interval. However, for flow values that have units /s, /min, /h, or /day a simple summation results in the actual value not matching the computed result, because the scan interval and the unit of the input values are different. In these cases, the unit of the data measured over the scan interval is converted to match the unit of the input values and the computation is performed.

For example, if the scan interval is 2 s, and the input value is 100 m³/min, a simple summation would add 100 every 2 s resulting in 3000 after one minute. However, if the sum unit is set to /min, then 2 s/60 s is multiplied every scan interval before the value is added giving a result that has a m³/min unit. The following equations are applied. The scan interval unit is in seconds.

- Off $\sum(\text{measured value})$
- /s $\sum(\text{measured value}) \times \text{scan interval}$
- /min $\sum(\text{measured value}) \times \text{scan interval}/60$
- /h $\sum(\text{measured value}) \times \text{scan interval}/3600$
- /day $\sum(\text{measured value}) \times \text{scan interval}/86400$

For the setting procedure, see section 11.13.

If power is lost while the report function is in progress

If a power disruption occurred while the report function was in progress, the report function will resume after the power is restored. The exact operation will vary depending on whether the power is restored before or after the scheduled time to create a report.

Time of Recovery	Report Operation
After the time to create the report	Report data are created immediately after power is restored. The measured/computed data up to the time of the power disruption are used. For the next scheduled report, data after the power recovery are used.
Before the time to create the report	After power is restored, report data are created at the time of the next normally scheduled report. All measured/computed data excluding the power disruption period are used.

How the measured/computed data are handled when there is an abnormality in the data

Type of Abnormal Data	Report Data		
	Average value	Maximum/Minimum value	Sum value
Positive over*	not used	used	not used
Negative over*	not used	used	not used
Error	not used	not used	not used

* "over range" for measurement channels or "computation overflow" for computation channels

Displaying the report

Report data display

The reports can be displayed from the [Information] - [Memory Summary] menu in the operation mode. See section 4.5.

Status display

If the data of a measurement or a computation channel enter any of the conditions listed below within the relevant time period (one hour for hourly reports and one day for daily reports, for example), status is output to the report. For the displayed position, see the report data output example in section 4.5.

Power Failure/Time Change	Status
Power failure	P
Time change	C

11.11 Overview of the Report Function

Data Condition	Status
Common to measurement and computation channels	
Measurement error or computation error	E
For measurement channels	
Positive (+) over range	O
Negative (–) over range	O
Over range occurs when the input type is voltage and the input exceeds $\pm 5\%$ of the measurable range. For example, consider the case when the measurement range is 2 V and the measurable range is from -2.000 to 2.000 V. If the input signal exceeds 2.200 V, + over range occurs. If the input signal falls below -2.200 V, – over range occurs. Over range occurs when the input type is TC (thermocouple) or RTD (resistance temperature detector) and the input exceeds approximately $\pm 10^\circ\text{C}$ of the measurable range. For example, consider the case when the measurement range is R and the measurable range is from 0.0 to 1760.0°C . If the input signal exceeds approximately 1770.0°C , + over range occurs. If the input signal falls below approximately -10.0°C , – over range occurs.	
For computation channels	
Positive (+) computation overflow (when the value exceeds $3.4\text{E} + 38$)	O
Negative (–) computation overflow (when the value falls below $-3.4\text{E} + 38$)	O

Numerical display

The range of displayed values of report data is from -9999999 to 99999999 excluding the decimal point. The decimal point position corresponds to the position of the decimal point of the upper and lower limit span of the computation channel.

However, special displays are used for cases given in the table below.

• Measurement channel

Item	Data Condition of Measurement Channels	Displayed value
AVE (Average value)	When all data are measurement errors or over range	(Blank)
MAX, MIN (Maximum value, minimum value)	<ul style="list-style-type: none"> When all data are measurement errors Positive (+) over range Negative (–) over range 	(Blank) 99999 -99999
SUM (Sum value)	<ul style="list-style-type: none"> When all data are measurement errors or over range When the sum value exceeds $3.4\text{E} + 38$ When the sum value is below $-3.4\text{E} + 38$ 	(Blank) 9.999999E + 99 -9.999999E + 99

• Computation channel

Item	Data Condition of Computation Channels	Displayed value
AVE (Average value)	When all data are computation errors or over range	(Blank)
MAX, MIN (Maximum value, minimum value)	<ul style="list-style-type: none"> When all data are computation errors When the maximum value exceeds 99999999 When the minimum value is below -99999999 	(Blank) 999999999 -999999999
The decimal position that was specified when the span for the equation was specified is reflected in the maximum and minimum values. For example, if the span setting of the equation is "200.0," then "99999999" is output when the value exceeds "99999999.9" and "-99999999" is output when the value is below "-999999.9."		
SUM (Sum value)	<ul style="list-style-type: none"> When all data are computation errors or computation overflow When the sum value exceeds $3.4\text{E} + 38$ When the sum value is below $-3.4\text{E} + 38$ 	(Blank) 9.999999E + 99 -9.999999E + 99

Storing to the internal memory and Saving to the external storage medium

Report data are stored to the internal memory at the end of each time interval.

The maximum number of report data files (data set for each interval) that can be stored in the internal memory is 40. For detail, see chapter 8.

11.12 Using the Report Function

Starting/Stopping the report function

The report start/stop is in sync with the data acquisition start/stop.

Procedure

Starting the report (also starts the data acquisition to the internal memory)

1. Press the START key. The icon that indicates the data acquisition to the internal memory turns to a start icon and the computation icon appears. For details related to the status display section, see section 4.2.
The report function starts. When the time to create the report arrives, the report data are stored to the internal memory.

Stopping the report (also stops the data acquisition to the internal memory)

1. Press the STOP key. A confirmation window opens. For models with the batch function (/BT1 option), the batch information is also displayed.
2. Use the arrow keys to select [Mem + Math] (stop the data acquisition to the internal memory and computation) or [Mem] (stop the data acquisition), and press the DISP/ENTER key.
The icon that indicates the data acquisition to the internal memory turns to a stop icon. The report stops.

Note

When the report function is stopped, the report file on the external storage medium is closed.
When the report function is started again, the data is saved to a new file.

Clearing the report data in the internal memory

These procedures are carried out in the setting mode. The report data are cleared along with the display data, for example. For the procedures, see section 9.7.

11.13 Setting the Report Function (Basic Setting Mode)

Set the report type, report channels, the time and date to create the report. The report function is set in the basic setting mode.

Procedure

- These procedures are carried out in the basic setting mode.
- Use the arrow keys to move the cursor (blue) to the appropriate parameter.
- The possible selections are displayed at the bottom of the screen. Select using the soft keys.
- The parameter boxes that are changed are displayed in yellow. By confirming the new settings, they change back to white.

Press .

Press  for 3 seconds. The menu screen for the basic setting mode appears.

Twice press the soft key .

Press the soft key .

To display the setting screen press the soft key .

Report		
Report set	Hour	1
Date	1	2
Time	0	3
Report CH	R01	4
On/Off	On	5
Channel	01	6
Sum scale	/s	7

The numbers in front of the operating procedure shown below correspond to the numbers in the above figure.

1. Report set
 - [Hour]: Creates hourly reports.
 - [Day]: Creates daily reports.
 - [Hour +Day]: Creates hourly and daily reports.
 - [Day+Week]: Creates daily and weekly reports.
 - [Day+Month]: Creates daily and monthly reports.
2. Date/Day of the week

This is the date or day of the week on which the report is created.

If the [Report set] is set to [Day+Month], [Date] is displayed. If [Day+Week] is specified, [Day] is displayed. If [Hour], [Day], or [Hour+Day] is specified, [Date] is displayed. However, this setting is void.

 - Date (for monthly reports)

Pressing the [Input] soft key displays a window used to enter the date. Enter the date (01-28)* and press the DISP/ENTER key. Procedures related to entering numerical values, see "Entering Numbers" on page 3-21.

* You cannot specify 29, 30 or 31.
 - Day (for weekly reports)

Enter the day of the week using the soft key.

3. Time (hour)
Set the time to create daily, weekly, and monthly reports with the time on the hour (00 to 23).
Enter the time using the same method as step 2.
This setting is void for hourly reports.
4. Report CH
This is the report channel to which the measurement/computation channel is assigned. Select from R01 to R12. The reports are output in order according to this number.
5. On/Off
[On]: Use the report channel.
[Off]: Do not use the report channel. The report data number and the data are not displayed.
6. Channel
Set the measurement or computation channel to assign to the report channel. All measurement and computation channels can be specified. However, the reports are not created for channels that are set to [Skip] or those that have the computation turned [Off].
7. Sum scale (sum unit)
Select [Off], [/s], [/min], [/h], or [/day]. See section 11.11.

Confirming operation

To confirm the new settings, press the DISP/ENTER key.

To cancel the new settings, press the ESC key. A window appears for you to confirm the cancellation. Select [Yes] using the arrow keys and press the DISP/ENTER key.

Explanation

Date/Day of the week

This is the date for monthly reports or the day of the week for weekly reports. The report is created at the specified time on the specified date or day of the week.

Time

This is the time at which daily, weekly, and monthly reports are created. Hourly reports are created every hour on the hour.

12.1 A List of Messages

Occasionally, error codes and messages appear on the screen while using the DX100L. The entire list of messages is given below. Error codes and messages related to communications are also listed here.

The messages are displayed in the language that you have chosen. For the procedures regarding language selection, see section 10.10.

Errors Related to Parameter Settings

• Setting Errors

Code	Message	Explanation/Countermeasures/Ref. section
1	System error.	Contact your nearest YOKOGAWA dealer.
2	Incorrect date or time setting.	See section 3.7.
3	A disabled channel is selected.	See Communication Interface User's Manual.
4	Incorrect function parameter.	See Communication Interface User's Manual.
5	The input numerical value exceeds the set range.	Enter a proper value.
6	Incorrect input character string.	Enter a proper character string.
7	Too many characters.	Enter specified number of characters.
8	Incorrect input mode.	See Communication Interface User's Manual.
9	Incorrect input range code.	See Communication Interface User's Manual.
21	Cannot set an alarm for a skipped channel.	See Communication Interface User's Manual.
22	The upper and lower span limits are equal.	See sections 5.1 to 5.7.
23	The upper and lower scale limits are equal.	See sections 5.5 and 5.6.
30	The partial boundary value exceeds the range of the span.	See section 7.11.
31	Partial expansion display is set ON for a SKIPPED channel.	See Communication Interface User's Manual.
35	The upper and lower limits of the display band are equal.	See section 7.9.
36	The lower limit of the display band is greater than the upper limit.	See section 7.9.
37	The display band is narrower than 4% of the entire display.	See section 7.9.
40	Incorrect group set character string.	See section 7.6.
41	There is no specified input channel.	See Communication Interface User's Manual.
42	Exceeded the number of channels which can be set.	See Communication Interface User's Manual.
43	A channel number cannot repeat in a group.	See section 7.6.
45	There is no character string saved in the clipboard.	Copy a character string to the clipboard.
46	The character string saved in the clipboard is too long.	Paste a character string with the specified number of characters.
61	There is no channel specified by the MATH expression.	See section 11.4.
62	MATH expression grammar is incorrect.	See section 11.2.
63	MATH expression sequence is incorrect.	See section 11.2.
64	MATH upper and lower span values are equal.	See section 11.4.
70	The range of the MATH constant is exceeded.	See section 11.4.
71	Set range of the MATH constant is exceeded.	See section 11.6.
81	All space or 'quit' string cannot be specified.	See section 10.6.
83	Duplicate used combination of user ID and password.	See section 10.6 (when /BT1 is equipped).
85	The login password is incorrect.	See section 10.5.
86	The key-lock release password is incorrect.	See section 10.3.
87	This key is locked.	See section 10.3.
88	This function is locked.	See section 10.3.
89	Press [FUNC] key to login.	See section 10.5.

12.1 A List of Messages

Code	Message	Explanation/Countermeasures/Ref. section
90	No permission to enter to the SETUP mode.	See sections 10.5 and 10.6.
91	Password is incorrect.	See sections 10.3 and 10.5.
92	Press [ESC] key to change to the operation mode.	Press the ESC key.
93	String including space or all space cannot be specified.	Spaces are not allowed in the Web user name and password.
94	More than one address cannot be specified.	Multiple addresses cannot be specified. Only a single sender is allowed.
100	IP address doesn't belong to class A, B, or C.	See Communication Interface User's Manual.
101	The result of the masked IP address is all 0s or 1s.	See Communication Interface User's Manual.
102	SUBNET mask is incorrect.	See Communication Interface User's Manual.
103	The net part of default gateway is not equal to that of IP address.	See Communication Interface User's Manual.
104	FTP client failed because the memory mode is 'manual'.	See Communication Interface User's Manual.

• Execution Errors

Code	Message	Explanation/Countermeasures/Ref. section
150	This action is not possible because sampling is in progress.	See sections 8.5 and 8.6.
151	This action is not possible during sampling or calculating.	See sections 8.5, 8.6, and 11.3.
152	This action is not possible because saving is in progress.	Wait till the saving ends.
153	This action is not possible because formatting is in progress.	Wait till the formatting ends.
155	The message is not written while sampling is stopped.	See sections 8.5 and 8.6.
160	Cannot load the specified data. Change the memory setting.	See sections 4.5, 9.3, and 9.4.

Operation Errors

• Errors related to external storage medium

Code	Message	Explanation/Countermeasures/Ref. section
200	Operation aborted because an error was found in media.	See Communication Interface User's Manual.
201	Not enough free space on media.	Use another storage medium.
202	Media is read-only.	Release the write protection.
210	Media has not been inserted.	Insert a storage medium into the drive.
211	Media is damaged or not formatted.	Use another storage medium or carry out formatting.
212	Format error.	Try formatting again or use another storage medium.
213	The file is read-only.	Access to other files or make the file write-enable.
214	There is no file or directory.	See Communication Interface User's Manual.
215	Exceeded the allowable number of files.	Delete files or change storage medium.
216	The file or directory name is incorrect.	See sections 8.9 and 9.1.
217	Unknown file type.	Access to other files.
218	Directory exists. Delete the directory or change directory name.	See section 8.9.
219	Invalid file or directory operation.	Cannot handle files and directories in the 2nd and deeper layers.
220	The file is already in use. Try again later.	Wait till file is free.
230	There is no setting file.	Access to other files.
231	Abnormal setting exists in file.	Access to other files.

• Errors related to historical trend

Code	Message	Explanation/Countermeasures/Ref. section
232	There is no available data.	This message may appear when recalling historical trend. Access to other files.
233	The specified historical data do not exist.	This message may appear when recalling historical trend. See section 4.5.
234	The specified channel is not assigned to the display group.	This message may appear when switching to trend or bar graph from overview. See sections 4.4 and 7.6.

• Errors related to e-mail and Web server

Code	Message	Explanation/Countermeasures/Ref. section
260	IP address is not set or ethernet function is not available.	The IP address is not specified. Check the IP address.
261	SMTP server is not found.	Occurs when the SMTP server is specified by name. • Check the DNS setting. • Check the SMTP server name.
262	Cannot initiate E-mail transmission.	• The host name of the DX is not correct. Check the host name. • The port number for SMTP server is not correct. Check the port number.
263	Sender's address rejected by the server.	Check the sender's address.
264	Some recipients' addresses are invalid.	Check the recipient's address.
265	SMTP protocol error.	May occur if a network failure (cable problems, duplicate addresses, network device failure, and so on) occurs in the middle of the e-mail transmission.
266	Ethernet cable is not connected.	Check the cable connection.
267	Could not connect to SMTP server.	• Check to see that the SMTP server is connected to the network. • If the SMTP server name is specified using an IP address, check to see that the IP address is correct.
268	E-mail transmission request failed.	Contact your nearest YOKOGAWA dealer.
269	E-mail transfer error.	May occur if a network failure (cable problems, duplicate addresses, network device failure, and so on) occurs in the middle of the e-mail transmission.
275	The current image cannot be output to the Web.	The setup screen cannot be output to the Web. This message is displayed on the Web screen.
276	Image data currently being created. Unable to perform key operation.	Try again a little later. This message is displayed on the Web screen.
277	Could not output screen to Web.	Failed to create the image. This message is displayed on the Web screen.

12.1 A List of Messages

- **Errors related to FTP client**

For information regarding the FTP client function of the DX100L, see the DX100/DX200 Communication Interface User's Manual (IM 04L02A01-17E).

Code	Message
280	<p>IP address is not set or FTP function is not available. Further details are provided by the character string that appears after error code 280.</p> <hr/> <p>Character String and Details</p> <hr/> <p>HOSTADDR The DX's IP address has not been specified. Check the IP address.*¹</p> <p>DORMANT Internal processing error.*²</p> <p>LINK Data link is disconnected. Check the cable connection.</p> <hr/>
281	<p>FTP mail box operation error. Further details are provided by the character string that appears after error code 281.</p> <hr/> <p>Character String and Details</p> <hr/> <p>MAIL Internal processing error.*²</p> <p>STATUS Internal processing error.*²</p> <p>TIMEOUT Internal processing error.*²</p> <p>PRIORITY Internal processing error.*²</p> <p>NVRAM Internal processing error.*²</p> <hr/>
282	<p>FTP control connection error. Further details are provided by the character string that appears after error code 282.</p> <hr/> <p>Character String and Details</p> <hr/> <p>HOSTNAME Failed the DNS lookup (search the IP address corresponding to the host name). Check the DNS setting and the destination host name.</p> <p>TCPIP Internal processing error.*²</p> <p>UNREACH Failed to connect to a control connection server. Check the address setting and that the server is running.</p> <p>OOBINLINE Internal processing error.*²</p> <p>NAME Internal processing error.*²</p> <p>CTRL The control connection does not exist. Check that the server does not drop the connection and that it responds within the proper time period.</p> <p>IAC Failed to respond in the TELNET sequence. Check that the server does not drop the connection and that it responds within the proper time period.</p> <p>ECHO Failed to transmit data on the control connection. Check that the server does not drop the connection and that it responds within the proper time period.</p> <p>REPLY Failed to receive data on the control connection. Check that the server does not drop the connection and that it responds within the proper time period.</p> <p>SERVER The server is not in a condition to provide the service. Check that the server is in a condition in which service can be provided.</p> <hr/>

Code Message

283 FTP command was not accepted.

Further details are provided by the character string that appears after error code 283.

Character String and Details

USER

Failed user name verification.
Check the user name setting.

PASS

Failed password verification
Check the password setting.

ACCT

Failed account verification.
Check the account setting.

TYPE

Failed to change the transfer type.
Check that the server supports the binary transfer mode.

CWD

Failed to change the directory.
Check the initial path setting.

PORT

Failed to set the transfer connection.
Check that the security function is disabled.

PASV

Failed to set the transfer connection.
Check that the server supports PASV commands.

SCAN

Failed to read the transfer connection settings.
Check that proper response to the PASV command is received from the server.

284 FTP transfer setting error.

Further details are provided by the character string that appears after error code 284.

Character String and Details

MODE

Internal processing error.*2

LOCAL

Internal processing error.*2

REMOTE

The destination file name is not correct.
Check that you have the authority to create or overwrite files.

ABORT

File transfer abort was requested by the server.
Check the server for the reason for the abort request.

12.1 A List of Messages

Code	Message
285	FTP data connection error. Further details are provided by the character string that appears after error code 285. Character String and Details SOCKET Failed to create a socket for the transfer connection.* ³ BIND Failed the transfer connection command.* ³ CONNECT Failed the transfer connection.* ³ LISTEN Failed the transfer connection reception.* ³ ACCEPT Failed to accept the transfer connection.* ³ SOCKNAME Internal processing error.* ² RECV Failed to receive data over the transfer connection.* ³ SEND Failed to send data over the transfer connection.* ³
286	FTP file transfer error.

*1 See the DX100/DX200 Communication Interface User's Manual (IM 04L02A01-17E).

*2 Contact your nearest YOKOGAWA dealer.

*3 These errors may occur if the network experiences trouble during the data transmission (bad cable connection, duplicate addresses, network equipment failure).

Note

- The FTP client function on the DX100L has a timer function that drops the connection if there is no data transfer for two minutes. If the server does not respond within this time period, the transfer fails.
- The FTP client function on the DX100L overwrites files with the same file names on the server without any warnings, unless the server rejects the request.
- For information regarding the FTP client function of the DX100L, see the DX100/DX200 Communication Interface User's Manual (IM 04L02A01-17E).

Communication Errors

For information regarding the communication function of the DX100L, see the DX100/DX200 Communication Interface User's Manual (IM 04L02A01-17E).

• Errors during Setting and Basic Setting Modes, Output Communication Command Execution, and Setup Data Loading

Code	Message
300	Command is too long.
301	Too many number of commands delimited with ';'.
302	This command has not been defined.
303	Data request command can not be enumerated with sub-delimiter.
350	Command is not permitted to the current user level.
351	This command cannot be specified in the current mode.
352	The option is not installed.
353	This command cannot be specified in the current setting.
354	This command is not available during sampling or calculating.

- **Memory Access Errors during Setting and Basic Setting Modes and Output Communication Command Execution**

An English error message is returned via the communication interface. It is not displayed on the screen.

Code	Message
360	Output interface must be chosen from Ethernet or RS by using 'XO' command.
361	The memory data is not saved for the communication output.
362	There are no data to send 'NEXT' or 'RESEND'.
363	All data have already been transferred.

- **Maintenance and Test Communication Command Errors**

An English error message is returned via the communication interface. It is not displayed on the screen.

Code	Message
390	Command error.
391	Delimiter error.
392	Parameter error.
393	No permission.
394	No such connection.
395	Use 'quit' to close this connection.
396	Failed to disconnect.
397	No TCP control block.

- **Other Communication Errors**

An English error message is returned via the communication interface. It is not displayed on the screen.

Code	Message
400	Input username.
401	Input password.
402	Select username from 'admin' or 'user'.
403	Login incorrect, try again!
404	No more login at the specified level is acceptable.
420	Connection has been lost.
421	The number of simultaneous connection has been exceeded.
422	Communication has timed-out.

Note

For information regarding the communication function of the DX100L, see the DX100/DX200 Communication Interface User's Manual (IM 04L02A01-17E).

12.1 A List of Messages

Status Messages

Code	Message
500	Execution is complete.
501	Please wait a moment...
503	Data are being saved to media...
504	File is being loaded from media...
505	Formatting...
506	Memory save to media was interrupted.
507	Exchange media to continue the saving operation.
510	Range cannot be changed during sampling or calculating.
511	MATH expression cannot be changed during sampling or calculating.
512	Because memory save is 'manual' mode, FTP is not available.
520	Connecting to the line...
521	The data file is being transferred.
551	FTP test is being executed...

Cautions

Code	Message	Ref. section
600	Measured data and Settings have been initialized.	–
601	Measured data have been initialized.	–
610	This username is already registered.	See section 10.6.
611	There is no user who can enter to the SETUP mode.	See section 10.6.

System Errors

Service is required when a system error occurs. Contact your nearest YOKOGAWA dealer for repairs.

Code	Message
901	ROM failure.
902	RAM failure.
910	A/D memory failure for all input channels.
911	Channel 1 A/D memory failure.
912	Channel 2 A/D memory failure.
913	Channel 3 A/D memory failure.
914	Channel 4 A/D memory failure.
921	Channel 1 A/D calibration value error.
922	Channel 2 A/D calibration value error.
923	Channel 3 A/D calibration value error.
924	Channel 4 A/D calibration value error.
930	Memory acquisition failure.
940	The Ethernet module is down.

12.2 Troubleshooting Flow Chart

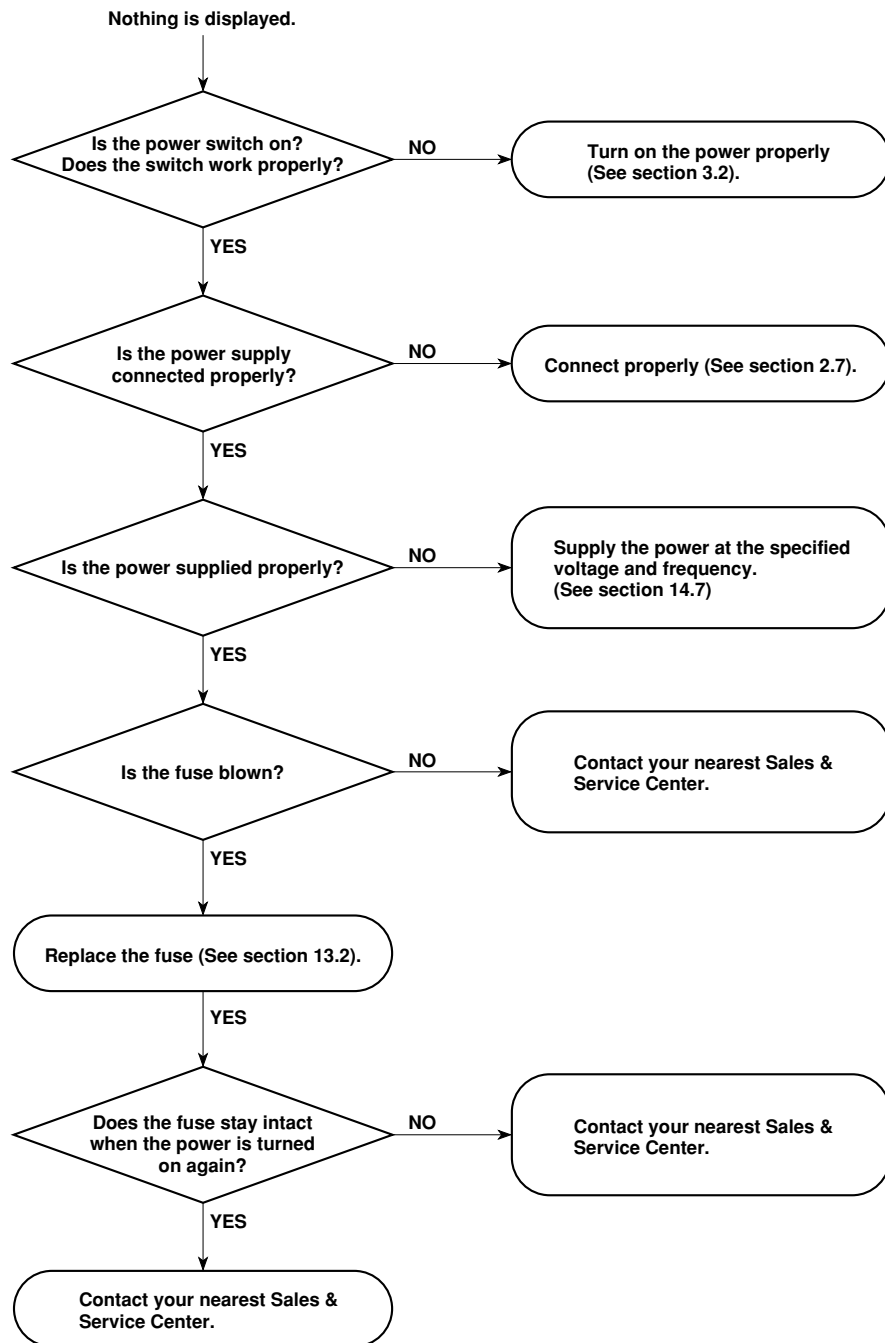

12.2 Troubleshooting Flow Chart

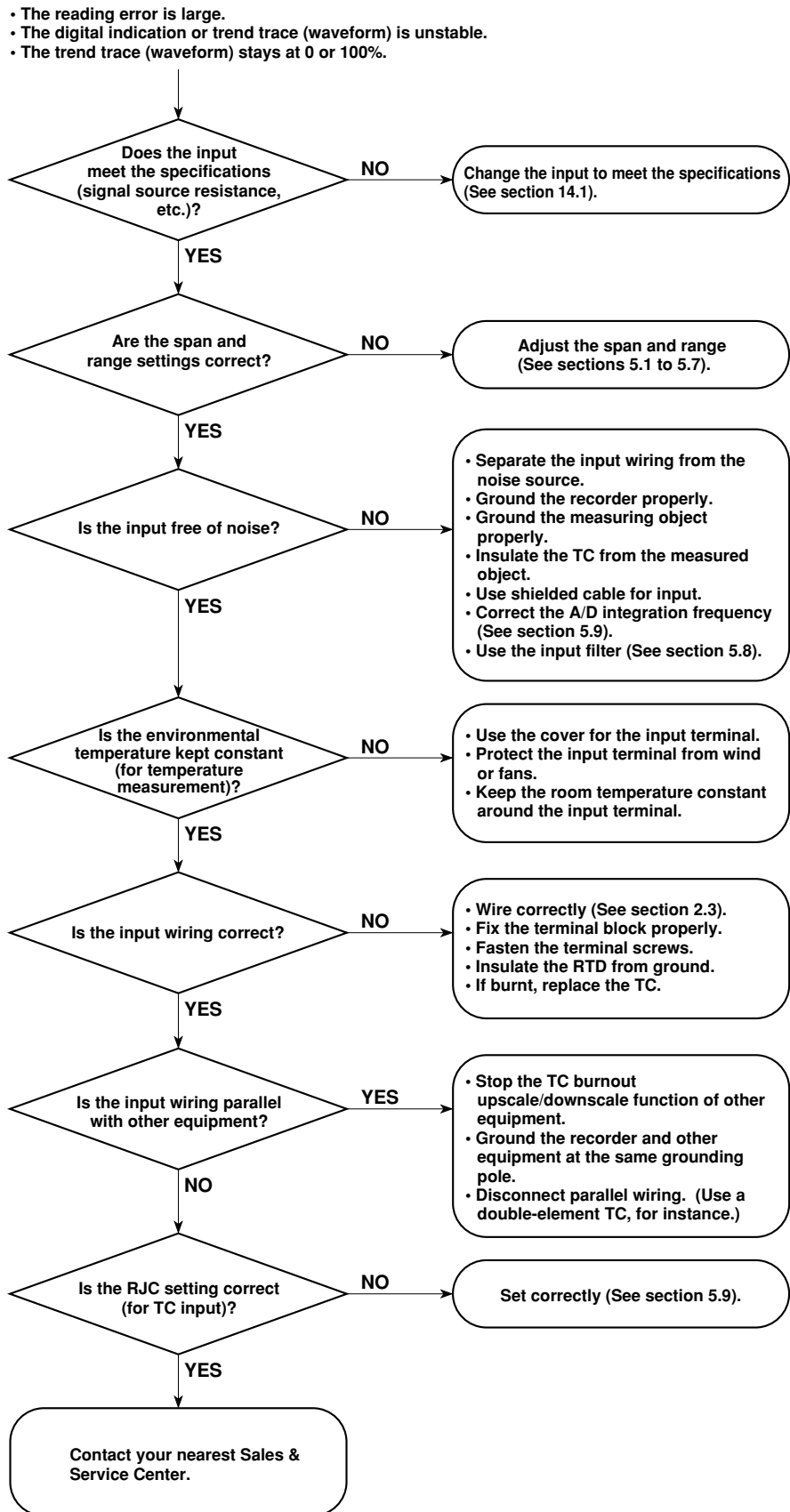

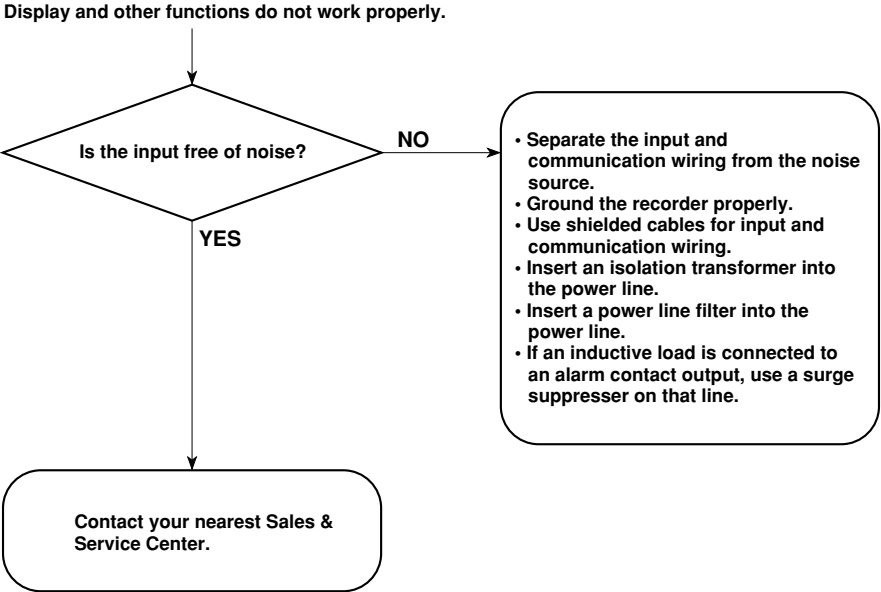

13.1 Periodic Maintenance

Check the operation periodically to keep the DX100L in good working order. Perform the following checks and replace worn parts as needed.

- Is the display and storage functioning properly?
In the event of problems, see section 12.2.
- Has the brightness of the LCD backlight deteriorated?
If replacement is necessary, see section 13.4 “Recommended Replacement Periods for Worn Parts.”

13.2 Replacing the Fuse

Replace the fuse every two years for preventive maintenance.



WARNING

- For safety reasons, make sure to turn OFF the power switch and disconnect the DX100L from the main power supply before replacing the fuse.
- To prevent the possibility of fire, use only the specified fuse purchased from YOKOGAWA.
- Never short circuit the fuse holder to bypass the use of a fuse.
- To avoid the possibility of electric shock, open the front panel only when replacing the fuse.
- Do not touch the rear side of the front panel when replacing the fuse, because it can become hot.
- Make sure not to damage the cable while replacing the fuse.

For fuse rating, see section 13.4 “Recommended Replacement Periods for Worn Parts.” Follow the procedures below to replace the fuse.

1. Turn OFF the power switch.
2. Disconnect the DX100L from the main power supply.
3. Open the cover and remove the two screws.
4. Pull the front panel slightly toward you and lift it.
5. While pressing the fuse carrier located to the right of the power switch, turn it counterclockwise approximately 45 degrees. The carrier and the fuse will slide out.
6. Replace with a new fuse, insert the carrier in the fuse holder, and turn it clockwise while pressing the carrier to fix it in place.
7. Lift the front panel slightly, and attach it to the top and then the bottom of the rubber packing. Secure the front panel with screws.

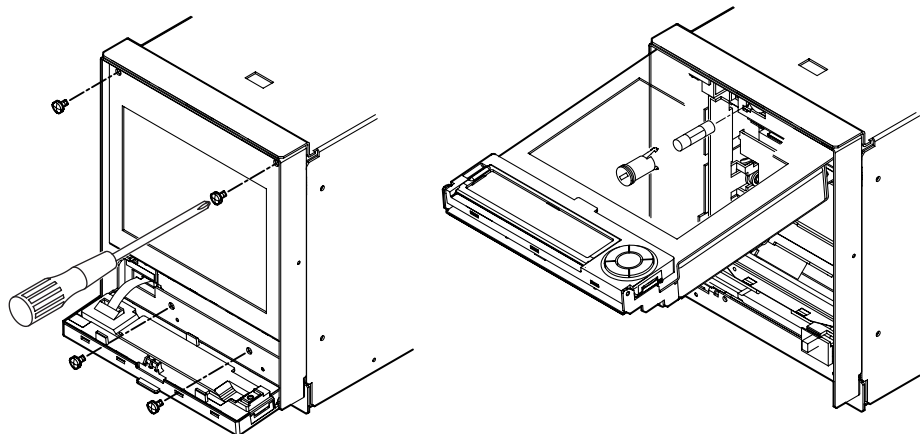

Note

For DX100Ls which are side-by-side mounted vertically, a front panel always interfere the upper one when it is opened so that front panels except the top one can't be opened directly. First open the top front panel and then the lower one by one. For the same reason, when closing front panels, first close the bottom front panel and then the upper one by one.

13.3 Calibration

To maintain the measurement accuracy, we recommend the DX100L be calibrated once a year. Calibration service is also provided by YOKOGAWA dealers. For details, contact your nearest YOKOGAWA dealer.

Required Instruments

For calibrating the DX100L, calibration instruments with the following resolution are necessary.

Recommended Instruments

- DC voltage standard: YOKOGAWA Model 2552 or equivalent
Main specifications
Accuracy of output in the range 20 mV to 20 V: $\pm 0.005\%$
- Decade resistance box: Yokogawa M&C Model 2793-01 or equivalent
Main specifications
Accuracy of output in the range 0.1 to 500 Ω : $\pm(0.01\%+2\text{ m}\Omega)$
Resolution: 0.001 Ω

(To purchase these instruments, contact the supplier of the DX100L .)

Calibration procedure

1. Connect the DX100L and the calibration instruments as shown in the following figure, and allow the instruments to warm-up adequately (warm-up time for the DX100L is at least 30 minutes).
2. Check that the ambient temperature and humidity are within the normal operating conditions (See chapter 14).
3. Apply input signals corresponding to 0, 50, and 100% of the specified input range and calculate the errors from the readings.
If the error is not within the accuracy specifications, contact your nearest YOKOGAWA dealer.

Note

For TC input, the temperature of the input terminals must be measured and a voltage corresponding to the temperature at the reference junction must be added.

DC Voltage Measurement (Example for the DX112L)

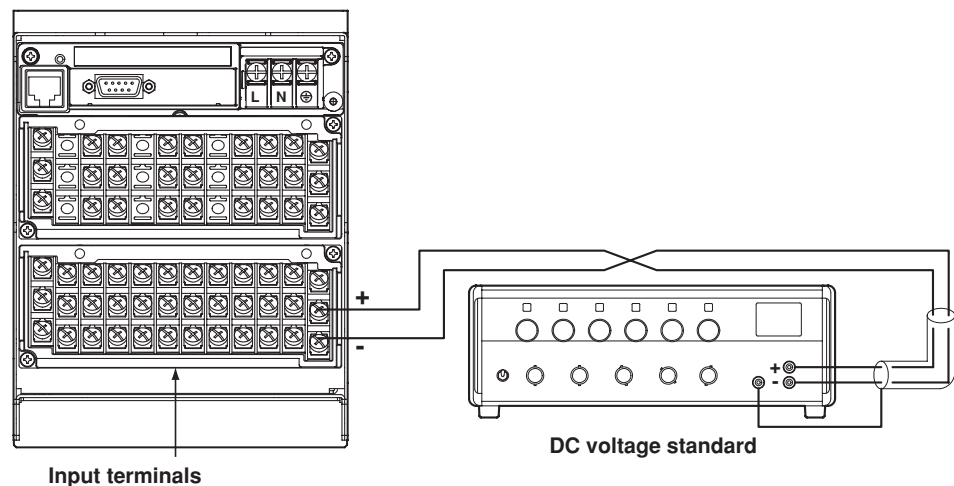

Temperature Measurement Using the RTD (Example for the DX112L)

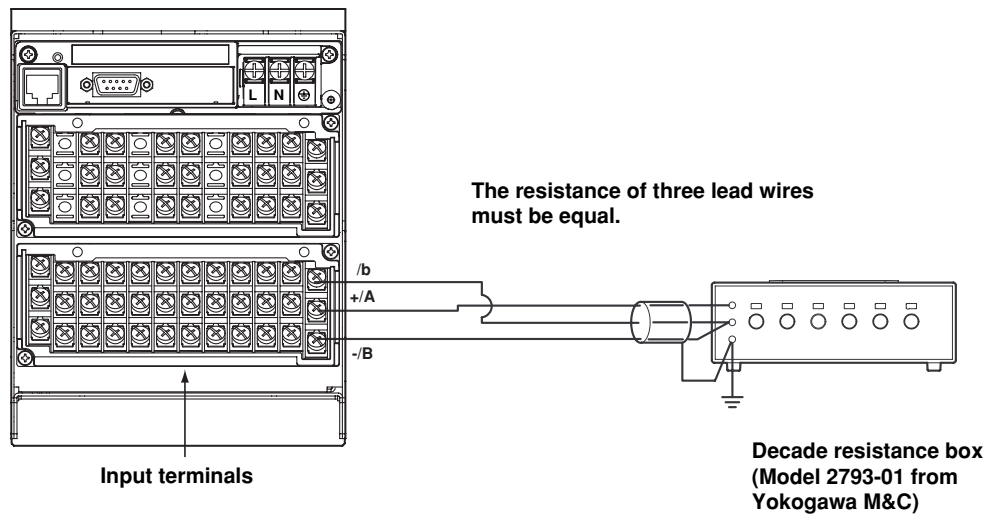

Temperature Measurement Using the TC (Example for the DX112L)

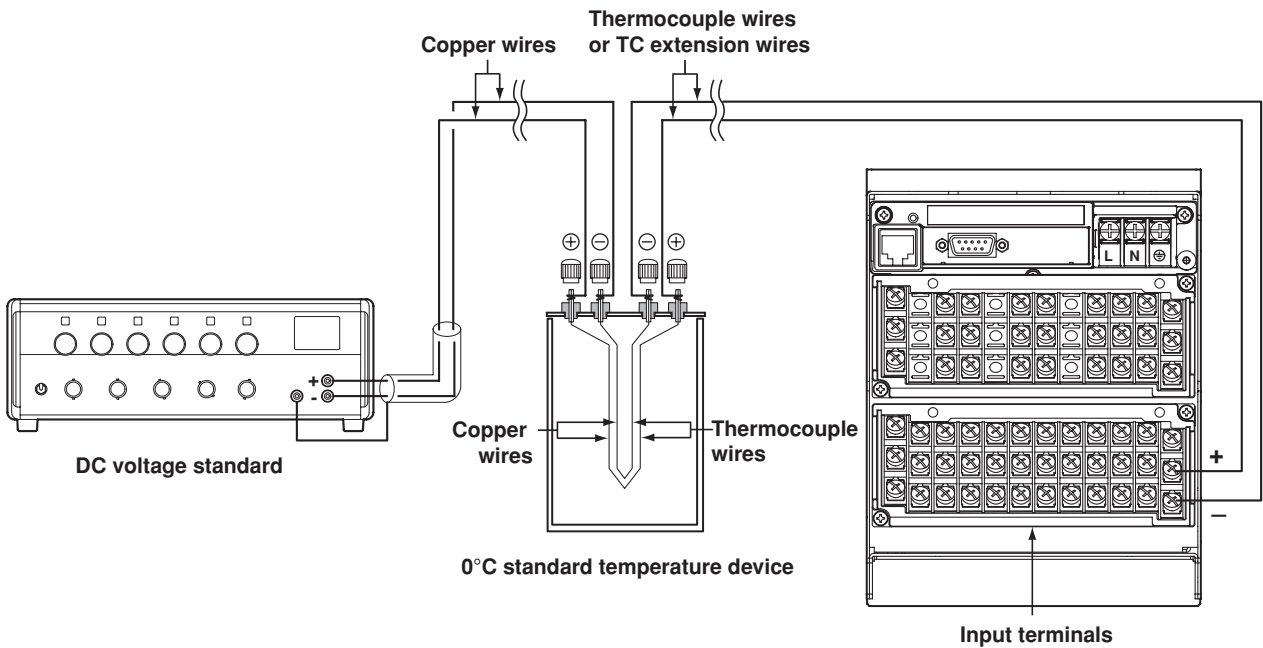

Reference Junction Compensation for the Thermocouple Input

As the measurement terminal of the DX100L is generally at room temperature, the actual output of the thermocouple is different from the values given on the thermoelectromotive force table based on 0°C. The DX100L measures the temperature of the terminal and makes adjustments by calculation. Therefore, when the measurement terminals are shorted (equivalent to 0°C at the detector tip), the temperature at the measurement terminal is displayed. When calibrating the DX100L, this compensation voltage (thermoelectromotive force of 0 °C reference corresponding to the input terminal temperature) must be subtracted from the output of the standard generator before application. As shown in the figure, by using the 0 °C standard temperature device to compensate the reference junction at 0 °C, you can input the thermoelectromotive force of 0 °C reference from the DC voltage standard and make the calibration.

13.4 Recommended Replacement Periods for Worn Parts

To maintain the reliability of the DX100L and to use it in good working order for a long time, we recommend periodic replacement of worn parts as preventive maintenance. The replacement parts may change to accommodate preventive maintenance over extended time. Be sure to check with your nearest YOKOGAWA dealer.

The recommended replacement periods for worn parts are shown in the following table. The replacement periods apply when the DX100L is operated under standard operating conditions.

Please consider the actual operating conditions when determining the actual replacement periods for your DX100L.

The replacement of the worn parts except the fuse must be conducted by a qualified YOKOGAWA personnel. Contact your nearest YOKOGAWA dealer to have the LCD replaced.

Item	Replacement Period	Part Name	Part Number	Specifications	Quantity Used
Fuse	2 years	FUSE	A1347EF	250 V, 1 A, time lag (except for /P1 model)	1
	2 years	FUSE	A1352EF	250 V, 4 A, time lag (for /P1 model)	1
LCD	5 years	Back light module			1
Battery	10 years	Lithium battery			1
Rubber strip	5 years	Dust and water proof rubber strip		for front panel, for front cover	1 each
Floppy disk drive	5 years				1
Zip drive	5 years				1
PWB assembly	5 years	Power Assy*			1
	5 years	Sub Power Assy*			1
	5 years	AD Assy*			Up to models

* Replacement Period at the Upper Limit of the Normal Operating Temperature (50°C)
The replacement period varies depending on the temperature in which the instrument is operated, and the instrument's specifications. If the instrument is used in a 30°C environment, it may be operational for 10 years or more.

Note

- The LCD replacement period indicates the half life of the brightness when the brightness is set to the factory default setting. The half life is shortened as the brightness is set higher. The deterioration of brightness varies depending on the condition of use, and its determination is subjective. Consider these facts for determining the actual replacement period.
- The color of the LCD may become yellowish as time elapses. The discoloration tends to progress faster as the brightness is set higher.

14.1 Input Specifications

Number of Inputs:	DX102L: two channels DX104L: four channels DX106L: six channels DX112L: twelve channels
Scan Interval:	DX102L, DX104L: 125 ms or 250 ms DX106L, DX112L: 1 s or 2 s (2 s when an A/D integration time is set to 100 ms)
Inputs:	Volt (DC voltage), TC (thermocouple), RTD (resistance temperature detector), DI (digital input), DC current (with external shunt resistor attached)

Input type	Range	Measuring range
Volt	20 mV	-20.00 to 20.00 mV
	60 mV	-60.00 to 60.00 mV
	200 mV	-200.0 to 200.0 mV
	2 V	-2.000 to 2.000 V
	6 V	-6.000 to 6.000 V
	20 V	-20.00 to 20.00 V
	50 V	-50.00 to 50.00 V
TC	R ^{*1}	0.0 to 1760°C 32 to 3200°F
	S ^{*1}	0.0 to 1760°C 32 to 3200°F
	B ^{*1}	0.0 to 1820°C 32 to 3308°F
	K ^{*1}	-200.0 to 1370°C -328 to 2498°F
	E ^{*1}	-200.0 to 800°C -328.0 to 1472.0°F
	J ^{*1}	-200.0 to 1100°C -328.0 to 2012.0°F
	T ^{*1}	-200.0 to 400°C -328.0 to 752.0°F
	N ^{*1}	0.0 to 1300°C 32 to 2372°F
	W ^{*2}	0.0 to 2315°C 32 to 4199°F
	L ^{*3}	-200.0 to 900°C -328.0 to 1652.0°F
	U ^{*3}	-200.0 to 400°C -328.0 to 752.0°F
RTD ^{*5}	Pt100 ^{*4}	-200.0 to 600°C -328.0 to 1112.0°F
	JPt100 ^{*4}	-200.0 to 550°C -328.0 to 1022.0°F
DI	DCV input (TTL)	OFF: less than 2.4 V ON: more than 2.4 V
	Contact input	Contact ON/OFF

*1 R, S, B, K, E, J, T, N: IEC584-1 (1995), DIN IEC584, JIS C1602-1995

*2 W: W-5% Re/W-26% Re (Hoskins Mfg. Co.), ASTM E988

*3 L: Fe-CuNi, DIN43710, U: Cu-CuNi, DIN43710

*4 Pt100: JIS C1604-1997, IEC751-1995, DIN IEC751-1996

JPt100: JIS C1604-1989, JIS C1606-1989

*5 Measuring current: $i = 1 \text{ mA}$

A/D Integration Time:	Selectable from 20 ms (50 Hz), 16.7 ms (60 Hz), 100 ms (50/60 Hz for DX106L/112), or AUTO (automatic selection from 20 ms and 16.7 ms by detection of power supply frequency)
Thermocouple Burnout:	Burnout upscale/downscale function can be switched ON/OFF (for each channel). Burnout upscale/downscale selectable
Filter:	DX102L, DX104L: Signal damping On/off selectable for each channel Time constant: selectable from 2, 5, and 10 seconds DX106L, DX112L: Moving average On/off selectable for each channel Number of samples to be averaged is selectable from 2 to 16

14.1 Input Specifications

Computation:	Differential computation:	Between any two channels Available for Volt, TC, RTD, and DI ranges.
	Linear scaling:	Available for Volt, TC, RTD, and DI ranges. Scaling limits: -30000 to 30000 Decimal point: user selectable Engineering unit: user definable, up to 6 characters
	Square root:	Square root computation and linear scaling Available for Volt range. Scaling limits: -30000 to 30000 Decimal point: user selectable Engineering unit: user definable, up to 6 characters

14.2 Display Specifications

Display unit:	5.5-inch TFT color LCD (VGA, 240 × 320 dot resolution)
Channel display color:	Trend/Bar graph: Selectable from 16 colors (Red, Green, Blue, Blue violet, Brown, Orange, Yellow green, Lightblue, Violet, Gray, Lime, Cyan, Darkblue, Yellow, Light Gray, Purple) Initial settings of channel display color: Channel 1: Red, Channel 2: Green, Channel 3: Blue, Channel 4: Blue violet, Channel 5: Brown, Channel 6: Orange, Channel 7: Yellow-green, Channel 8: Light blue, Channel 9: violet, Channel 10: Gray, Channel 11: Lime 12: Cyan
Trend screen:	Background: White or black selectable Direction: vertical or horizontal selectable Number of indication channels: 6 channels per screen (maximum) Number of group screens: 4 All channels indication: 24 channels (maximum, including computation channels) Line width: 1, 2, and 3 dots selectable Display update rate: Waveform: (One division has 30 dots.) • DX102L, DX104L: 15 s, 30 s, 1, 2, 5, 10, 20, 30 min., 1, 2, 4, 10 hours/div selectable • DX106L, DX112L: 1, 2, 5, 10, 20, 30 min., 1, 2, 4, 10 hours/div selectable Numerical value: 1 s (2 s when the scan interval is 2 s.) Contents: Waveform, Numerical value (numerical display section can be turned ON/OFF), scale (scale display can be turned ON/OFF), grid lines (number of divisions selectable from 4 to 12), hours : minutes on time axis, trip lines (line widths are selectable from 1, 2 and 3 dots), messages (up to eight different messages of up to 16 characters for each), alarm indication Zone display and partial expanded display are available.
Bar graph screen:	Direction: Vertical or horizontal selectable Number of indication channels: 6 channels per screen (maximum) Number of group screens: 4 Scales: 4 to 12 divisions selectable Base position of bar: Left, right or center (only for horizontal display) Display update rate: 1 s (2 s when the scan interval is 2 s) Contents: Bar graph, numerical value, unit, scale, alarm indication

14.2 Display Specifications

Digital screen:	Number of indication channels: 6 channels per screen (maximum) Number of group screens: 4 Display update rate: 1 s (2 s when the scan interval is 2 s) Contents: Numerical value, unit, alarm indication
Automatic display switching:	The displayed group can be automatically changed on the trend, digital, and bar graph screens. The display switching interval is selectable from 5 s, 10 s, 20 s, 30 s, and 1 min.
Overview screen:	Number of indication channels: Measured values and alarm status of all channels
Information screen:	Alarm summary: Displays the list of alarms. Capable to switch to historical trend screen by cursor pointing. Message summary: Display the list of messages and time. Capable to switch to historical trend screen by cursor pointing. Memory summary: Display the file list in internal memory. Capable to switch to historical trend screen by cursor pointing.
Tags:	Number of characters: 16 characters maximum
Historical trend screen:	Display the retrieved data from internal or external memory. Display format: Whole screen display or divided into 2 areas (only when displaying the historical trend of the display data) Time axis operation: Can be expanded, reduced, and scrolled Memory information: The following information of the retrieved data are displayed: File name, serial number of the DX which is used to acquire data, starting and ending time of data acquisition, user name (when using key login function), and batch information (models with /BT1)
Log display:	Display the logs of error messages, key login/logout, communication interface commands, and file transfers via FTP.
System screen:	Display the number of input points, capacity of the internal memory, options, MAC address, and firmware version number.
Backlight saver function:	The LCD backlight automatically dims if no key is pressed for a certain preset time (can be set from 1, 2, 5, 10, 20 and 60 minutes).
Display language:	Selectable from English, German, French, and Japanese.
Temperature unit:	°C or °F selectable

14.3 Data Storage Specifications

External storage medium:	Selectable from: 1) 3.5-inch floppy disk (2HD, 1.44 MB) 2) PCMCIA ATA flash memory card (4 to 440 MB), or CF card (32 to 512 MB, adapter required) 3) Zip disk (100 MB or 250 MB): This product is no longer produced.
Saving method:	Manual or automatic selectable
Manual saving:	Data saving by inserting external storage medium
Automatic saving:	Display data: Periodic saving (10 min to 31 days) to external storage medium Event data: In case of trigger free...Periodic saving (3 min to 31 days) to external storage medium In case of using trigger...Save the data when data acquisition is finished
Sampling Interval:	Display data: Linked with the waveform display update rate Event data: Linked with the specified sampling interval
Sampling Interval for Event Data:	A sampling interval that is faster than the scan interval cannot be specified.
30,	DX102L, DX104L: Selectable from 125, 250, 500 ms, and 1, 2, 5, 10, 60, 120 s, 300 s, 600 s
s	DX106L, DX112L: Selectable from 1, 2, 5, 10, 30, 60, 120, 300, and 600 s
File types:	The following two file types can be created. <ul style="list-style-type: none">• Event data file (stores instantaneous values acquired periodically at a specified sampling interval)• Display data file (stores the maximum and minimum values for each sampling interval from among measured data acquired at scan intervals) Files can be created in the following combinations. <ul style="list-style-type: none">• Event data file (only for trigger mode) + display data file• Display data file only• Event data file only Data format: Binary Data size per channel: Display data: Measurement data...4 bytes/datum, computation data...8 bytes/datum Event data: Measurement data...2 bytes/datum, computation data...4 bytes/datum
Modes for event data:	Event data only: Selectable from Free, Trigger or Rotate Display data + Event data: Selectable from Trigger or Rotate
Sampling length:	The sampling length (the maximum data length) can be derived from the following equation. Sampling length = the maximum number of data points per channel × sampling interval Maximum number of data points per channel: calculated from internal memory capacity, types of data, data size, and number of measurement or computation channels data to be stored

14.3 Data Storage Specifications

Internal memory capacity

Data type	Capacity of internal memory
Display data only	1.2 MB
Display data and event data	Display data: 0.9 MB Event data: 0.3 MB
Event data only	1.2 MB

Maximum number of data points per channel that can be stored

Data type	Maximum number of data points per channel
Display data only	1,200,000 bytes/(number of measurement channels × 4 + number of computation channels × 8) Except, the maximum number of data points is 100,000
Display data and event data	<ul style="list-style-type: none"> • Display data 900,000 bytes/(number of measurement channels × 4 + number of computation channels × 8) Except, the maximum number of data points is 75,000 • Event data 300,000 bytes/(number of measurement channels × 2 + number of computation channels × 4) Except, the maximum number of data points is 30,000
Event data only	1,200,000 bytes/(number of measurement channels × 2 + number of computation channels × 4) Except, the maximum number of data points is 120,000

This logic is explained in more detail below:

1) When acquiring display data only

If we assume that the number of measuring channels is 20, the number of computing channels is 10, and the display rate is 30 min/div (60 sec sampling interval), then:

$$\text{Number of data per channel} = 1,200,000 \text{ bytes} / (20 \times 4 \text{ bytes} + 10 \times 8 \text{ bytes}) = 7,500 \text{ data}^*$$

* Maximum number of data points is 100,000.

$$\text{Sampling length per file} = 7,500 \times 60 \text{ sec} = 450,000 \text{ sec} = \text{approx. 5 days}$$

2) When acquiring event data only

If we assume that the number of measuring channels is 20, the number of computing channels is 10, and the sampling interval is 1 sec, then:

$$\text{Number of data per channel} = 1,200,000 \text{ bytes} / (20 \times 2 \text{ bytes} + 10 \times 4 \text{ bytes}) = 15,000 \text{ data}^*$$

* Maximum number of data points is 100,000.

$$\text{Sampling length} = 15,000 \times 1 \text{ sec} = 15,000 \text{ sec} = \text{approx. 4 hours}$$

3) When acquiring both display data and event data

The sampling length is calculated by defining the capacity for display data as 900,000 bytes and the capacity for event data as 300,000 bytes. The method of calculation is the same as shown above.

Except, the maximum number of data points is 75,000 for display data and 30,000 for event data.

Example of sampling length:

In case measurement ch = 4 ch, mathematical ch = 0 ch

Display data file only (approx.)

Display rate (min/div)	1 min	5 min	20 min	30 min	60 min	240 min
Sampling interval (s)	2 s	10 s	40 s	60 s	120 s	480 s
Sampling length	41 h	8 days	34 days	52 days	104 days	416 days

Event data file only (approx.)

Sampling interval	125 ms	500 ms	1 s	5 s	30 s	120 s
Sampling length	4.2 h	16 h	33 h	6 days	41 days	166 days

Display data file + Event data file

Display data file (approx.)

Display rate (min/div)	1 min	5 min	20 min	30 min	60 min	240 min
Sampling interval (s)	2 s	10 s	40 s	60 s	120 s	480 s
Sampling length	31 h	6 days	26 days	39 days	78 days	312 days

Event data file (approx.)

Sampling interval	125 ms	500 ms	1 s	5 s	30 s	120 s
Sampling length	1 h	4.2 h	8.3 h	41 h	10 days	41 days

In case measurement ch = 6 ch, mathematical ch = 0 ch

Display data file only (approx.)

Display rate (min/div)	1 min	5 min	20 min	30 min	60 min	240 min
Sampling interval (s)	2 s	10 s	40 s	60 s	120 s	480 s
Sampling length	27 h	5 days	23 days	34 days	69 days	277 days

Event data file only (approx.)

Sampling interval	1 s	5 s	10 s	30 s	60 s	120 s
Sampling length	27 h	5 days	11 days	34 days	69 days	138 days

Display data file + Event data file

Display data file (approx.)

Display rate (min/div)	1 min	5 min	20 min	30 min	60 min	240 min
Sampling interval (s)	2 s	10 s	40 s	60 s	120 s	480 s
Sampling length	20 h	4 days	17 days	26 days	52 days	208 days

Event data file (approx.)

Sampling interval	1 s	5 s	10 s	30 s	60 s	120 s
Sampling length	6.9 h	34 h	2 days	8 days	17 days	34 days

Manual sampled data:

Trigger: Key operation, communication command, or remote input signals (/R1 option)

Data format: ASCII

Max. number of data sets internal memory can hold: 50

TLOG data (/M1 option):

Trigger: Timeout of the timer

Data format: Binary

Max. number of data sets or files internal memory can hold: 400 data sets or 16 files (number of START/STOP operations)

Report data (/M1 option):

Types: Hourly, daily, hourly + daily, daily + monthly and daily + weekly

Data format: ASCII

Max. number of report data internal memory can hold: 40

Screen image data:

Trigger: Key operation, communication command, or remote input signals (/R1 option)

Data format: png format

Output: External storage medium or communication interface

14.4 Alarm Function Specifications

Number of alarms:	Up to four alarms for each channel
Alarm types:	Upper and lower limits, delay upper and lower limits, difference upper and lower limits, and upper limit and lower on rate-of-change
Alarm delay time:	Selectable from 1 s to 3600 s for each channel
Interval time of rate-of-change alarms:	The scan interval times 1 to 15, common to all channels.
Display:	The alarm status (type) is displayed in the numerical value display area upon occurrence of an alarm. A common alarm indication is also displayed in the status display section. The alarm indication behavior: non-hold or hold-type can be selectable for common to all channels.
Hysteresis:	On (0.5% of display span)/off selectable (applied to upper and lower limits alarms, common to all measurement channels)
Relay outputs (option):	Number of points: 2, 4, 6 points Relay action: Energized/de-energized, hold/non-hold, AND/OR, reflash actions selectable. The alarm relay condition is held even in the basic setting mode.
Alarm information:	The date and time of alarm occurrences/recoveries, alarm types, etc. Up to 120 latest alarms are stored in the internal memory. Displayed on the alarm summary screen.

14.5 Specifications of Communication Functions

Connection:	Ethernet (10BASE-T)
Protocols:	TCP/IP
FTP client functions:	Automatic file transport from the DX100L (FTP client protocol)
FTP server functions:	File transport on request by host computer (FTP server protocol) Directory operation, file output, and file delete on the external storage medium
Files can be transported:	Display data file, event data file and report data file
Real time monitor function:	Monitor the measured/computed data on the DX100L. YOKOGAWA private protocol is used.
E-mail transmission function:	E-mail is automatically transmitted at the following times. Alarm activation/release, recovery from a power failure, memory end detection, occurrence of error related to the external storage medium and FTP client, at the specified time, and report creation. Destination: Specify two groups of destinations.
Web server function:	Displays the DX100L screen on the Internet Explorer browser. <ul style="list-style-type: none">• Browser: Microsoft Internet Explorer 4.0 to 5.5• "Monitor" screen: Screen for monitoring• "Operator" screen: Switch the screen from the browser. Modify and write messages.• Set access control (user name and password) on each screen.

14.6 Specifications of Optional Functions

Alarm Output Relays (/AR1, /AR2, /A3):

An alarm signal is output from the rear panel as a relay contact signal.

/AR1 and /AR2 includes remote control functions (/R1)

Relay contact rating: 250 VAC (50/60 Hz)/3 A, 250 VDC/0.1 A (for resistance load)

Terminal configuration: SPDT (NO-C-NC). Energized-at-alarm/de-energized-at-alarm, AND/OR, hold/non-hold, and reflash actions are selectable.

Batch Function (/BT1):

Information added to the measured/computed data:

Serial number of the DX100L, Application name, Supervisor name, Manager name, Batch number, Lot number, Comment information

Displaying information: Displays the application name, supervisor name, manager name, batch name, and comment when data acquisition to the internal memory is stopped.

Identifying operators (users) by using the key login function:

User names that are already registered cannot be specified. the combinations of user IDs and passwords that are identical to those that have been registered by any user in the past cannot be specified.

Messages: Messages 1 through 3 can be changed in the operation mode.

Confirming the stored data:

Batch information can be shown on the memory information display.

Serial Communication Interface (/C2, /C3):

This interface allows the host computer to control and make settings for the DX100L as well as receive data from the DX100L.

Connection: EIA RS-232 (/C2) or RS-422/485 (/C3)

Protocols: YOKOGAWA private protocol, Modbus protocol

Synchronization method: Start-stop asynchronous transmission

Connection method (RS-422/485):

4-wire half-duplex multi-drop connection
(1 : N where N = 1 to 31)

Transmission speed: 1200, 2400, 4800, 9600, 19200 or 38400 bps

Data length: 7 or 8 bits

Stop bit: 1 bit

Parity: Odd, even, or none

Communication distance (RS-422/485):

Up to 1200 m

Communication mode: ASCII for input/output for control and setting

ASCII or binary for output of measured data

Modbus:

Mode: RTU SLAVE, RTU MASTER

Data type: SLAVE: Data read and data write by the master device

MASTER: Data read from the slave device
(Computation function /M1 is necessary)

Wiring: 4 wires (for RS-422/485)

Fieldbus Communication Interface (/CF1)

Bidirectional digital communication with field devices and DCSs connected in a multidrop fashion according to the FOUNDATION Fieldbus standard specified by the Fieldbus Foundation.

Interface:	FOUNDATION Fieldbus H1 (transmission speed: 31.25 kb/s)
Physical layer type:	113 (standard-power signaling, bus powered, non I.S.)
External power supply:	supply voltage: 9 to 32 VDC
Supply current:	16.5 mA (maximum)
Connection:	M4 screws (2 terminals)
Dielectric strength:	Withstand voltage 500 V rms (50/60 Hz, for one minute) between communication terminal and ground terminal
Functional specification:	Function block: <ul style="list-style-type: none"> 8 AI function blocks (transmit measured/computed data to other instruments, one channel each) 1 MAI function block (transmit measured/computed data to other instruments, up to 8 channels) 1 MAO function block (receive measured data and other data from other instruments and record or display the data, up to 8 channels)
	Link master function
Others:	Computation function /M1 is necessary

FAIL/Memory End Output (/F1):

The relay contact output on the rear panel informs of the occurrence of a system error. Another relay contact output informs of the time until end of the internal memory space (selectable from 1, 2, 5, 10, 20, 50 or 100 hours) before the data is overwritten, or of the time when the remaining space on the external storage medium reaches to 10% of whole capacity.

Relay:	De-energized on system error Energized on memory end
Contact specification:	250 VDC/0.1 A (resistive load), 250 VAC (50/60 Hz)/3 A

Clamped Input Terminal (/H2):

Clamped input terminal is used for input terminal.

Computation Functions (/M1):

Can perform computation, display the computed data assigned to channels in trends and numerical values, and store computed data.

Channels assignable to computed data:

DX102L, DX104L: Up to 4 channels
DX106L, DX112L: Up to 12 channels

Operation:

General arithmetic operations:

Four arithmetic operations, square root, absolute, common logarithm, exponential, power, relational operations (<, ≤, >, ≥, =, ≠), logical operations (AND, OR, NOT, XOR)

Statistical operations:

Average, maximum, minimum summation, and maximum - minimum

Special operations:

Rolling average (moving average on computed results)

Constant:

Available (Up to 12 constants)

14.6 Specifications of Optional Functions

Digital input data via communication:	Digital data via communication can be used in calculation expression (Up to 12 data)
Remote input status:	Remote input status (0/1) can be used in calculation expression (Up to 8 inputs)
Report functions:	Report type: Hourly, daily, hourly + daily, daily + monthly, and daily + weekly Operation: Average, maximum, minimum and summation Data format: ASCII
TLOG data:	Saves all measured/computed data at the specified interval.

Cu10, Cu25 RTD Input /3 terminal isolated RTD Input (/N1):

This option allows Cu10 and Cu25 inputs to be added to the standard input types. A,B,b terminals are of isolated input type for DX106L and DX112L.

	Input type	Measuring range
RTD (measurement current : i = 1.25 mA)	Cu10 (GE)	-200 to 300°C
	Cu10 (L&N)	
	Cu10 (WEED)	
	Cu10 (BAILEY)	
	Cu10 : $\alpha = 0.00392$ at 20°C	
	Cu10 : $\alpha = 0.00393$ at 20°C	
	Cu25 : $\alpha = 0.00425$ at 0°C	

Measuring accuracy (Measuring accuracy for other inputs are the same as standard):

Input type	Accuracy guaranteed range	Measuring accuracy
Cu10 (GE)	-70 to 170°C	± (0.4% of rdg + 1.0°C)
Cu10 (L&N)	-75 to 150°C	
Cu10 (WEED)	-200 to 260°C	
Cu10 (BAILEY)	-200 to 300°C	
Cu10 : $\alpha = 0.00392$ at 20°C		± (0.3% of rdg + 0.8°C)
Cu10 : $\alpha = 0.00393$ at 20°C		
Cu25 : $\alpha = 0.00425$ at 0°C		
Pt100 Jpt100	Measuring range	± (0.3% of rdg + 0.6°C)

3 terminal Isolated RTD Input (/N2):

A, B, b terminals are of isolated input type.

* Can be specified only for DX106L and DX112L.

A,B,b terminals of DX102L and DX104L are isolated as standard.

24 VDC/AC Power Supply (/P1):

Powered by 24 VDC or 24 VAC.

For related specifications, see "Power Supply," "Normal Operating Conditions," "Effects of Operating Conditions," and "Other Specifications" in section 14.7.

Rated power supply: 24 VDC/AC

Allowable power supply voltage range:

21.6 to 26.4 VDC/AC

Dielectric strength: Power supply to ground terminal: 500 VAC (50/60 Hz), 1 minute

Rated power supply frequency:

50/60 Hz (for AC)

Allowable power supply frequency range:

50/60 Hz±2% (for AC)

Rated power consumption:

30 VA (for DC), 45 VA (for AC)

Power consumption:

Supply voltage	Backlight saving mode	Normal	Max.
24 VDC	17 VA	19 VA	30 VA
24 VAC(50/60Hz)	28 VA	32 VA	45 VA

Effects on measured value:

With variation within 21.6 to 26.4 V (50/60 Hz):

±1 digit or less

With variation of ±2 Hz from rated power supply frequency (at 24 VAC):

±(0.1% of rdg + 1 digit) or less

Remote Control (/R1):

This option allows the following functions to be controlled remotely by a contact or an open collector input (up to eight inputs):

- Alarm acknowledgment (trigger, 250 ms or longer)
- Start/stop of data acquisition (rising and falling edge)
- Trigger for event data acquisition (trigger, 250 ms or longer)
- Time adjustment (adjusting the internal clock to the nearest hour upon remote signal, trigger, 250 ms or longer)

Time of signal input	Processing
hh:00:00 to hh:01:59	Cut off reading of less than one minute. e.g. 10:00:50 is corrected as 10:00:00
hh:58:00 to hh:59:59	Round up reading of less than one minute. e.g. 10:59:50 is corrected as 11:00:00
hh:02:00 to hh:57:59	No process is to be performed.

- Start/stop of computation (rising and falling edge, /M1 option)
- Reset of computation data (trigger, 250 ms or longer, /M1 option)
- Manual sampling (trigger, 250 ms or longer)
- Writing messages (up to 8 different messages can be set, trigger, 250 ms or longer)
- Load of setting parameters (up to 3 setup data files can be set, trigger, 250 ms or longer)
- Snapshot (saves the current screen image data to the external storage medium)

24 VDC Power Supply for Transmitter (/TPS2 or /TPS4)

- Number of loops: 2(/TPS2) or 4(/TPS4)
- Output voltage: 22.8 to 25.2 VDC (under rated output current)
- Rated output current: 4 to 20 mADC
- Maximum output current: 25 mADC (overcurrent protection operation current: approximately 68 mADC.)
- Allowable cable resistance: $RL \leq (17.8 - \text{minimum operation voltage of transmitter})/0.02 \text{ A}$
- Where $17.8 \text{ V} = 22.8 \text{ V} - 5.0 \text{ V}$
- 22.8 V : Minimum output voltage
- 5 V : Maximum voltage across the load resistor (250 Ω)
- Maximum length of cable: 2 km (when using CEV cable)
- Insulation resistance: 20 MΩ or more (500 VDC) between output terminal and ground terminal
- Withstand voltage: 500 VAC (50/60 Hz, I = 10 mA) for one minute between output terminal and ground terminal
500 VAC (50/60 Hz, I = 10 mA) for one minute between output terminals

14.7 General Specifications

Construction

Mounting:	Flush panel mounting (on a vertical plane) Mounting may be inclined backward up to 30 degrees from a horizontal plane.
Allowable Panel Thickness:	2 to 26 mm
Material:	Case: drawn steel Bezel: polycarbonate
Case Color:	Case: Grayish blue green (Munsell 2.0B 5.0/1.7 or equivalent) Bezel: Charcoal grey light (Munsell 10B 3.6/0.3 or equivalent)
Front Panel:	Water and dust-proof (based on IEC529-IP65, and NEMA No.250 TYPE4 (except External Icing Test), except for side-by-side mounting)
Dimensions:	144(W) × 144(H) × 218(D) mm
Weight:	DX102L: approx. 2.9 kg DX104L: approx. 3.0 kg DX106L: approx. 3.0 kg DX112L: approx. 3.0 kg

Standard Performance

Measuring Accuracy:

The following specifications apply to operation of the DX100L under standard operation conditions:

Temperature:	23 ± 2°C
Humidity:	55% ± 10% RH
Power supply voltage:	90 to 132 or 180 to 250 VAC
Power supply frequency:	50/60 Hz ± 1%
Warm-up time:	At least 30 minutes.

Other ambient conditions such as vibration should not adversely affect the operation of the DX100L.

Input	Range	Measurement accuracy (digital display)	Max. resolution of digital display
DC voltage	20 mV	± (0.1% of rdg + 2 digits)	10 μV
	60 mV		10 μV
	200 mV		100 μV
	2 V		1 mV
	6 V		1 mV
	20 V		10 mV
	50 V		± (0.1% of rdg + 3 digits)
TC (Excluding the reference junction compensation accuracy)	R	± (0.15% of rdg + 1°C) However, R, S : ± 3.7°C at 0 to 100°C, ± 1.5°C at 100 to 300°C B : ± 2°C at 400 to 600°C (Accuracy at less than 400°C is not guaranteed.)	0.1°C
	S		
	B		
	K	± (0.15% of rdg + 0.7°C) However, ± (0.15% of rdg + 1°C) at -200 to -100°C	
	E	± (0.15% of rdg + 0.5°C)	
	J	± (0.15% of rdg + 0.5°C)	
	T	However, ± (0.15% of rdg + 0.7°C) at -200 to -100°C	
	N	± (0.15% of rdg + 0.7°C)	
	W	± (0.15% of rdg + 1°C)	
	L	± (0.15% of rdg + 0.5°C)	
RTD	U	However, ± (0.15% of rdg + 0.7°C) at -200 to -100°C	
	Pt100	± (0.15% of rdg + 0.3°C)	
	JPt100		

Measuring accuracy in case of scaling (digits):

Accuracy during scaling (digits) =
measuring accuracy (digits) × multiplier + 2 digits (rounded up)

where the multiplier = scaling span (digits)/measuring span (digits).

Example: Assuming that

- range: 6 V
- measuring span: 1.000 to 5.000 V
- scaling span: 0.000 to 2.000

Then,

Measuring accuracy = $\pm(0.1\% \times 5 \text{ V} + 2 \text{ digits})$
= $\pm(0.005 \text{ V [5 digits]} + 2)$
= $\pm(7 \text{ digits})$

Multiplier = $2000 \text{ digits (0.000 to 2.000)}/4000 \text{ digits (1.000 to 5.000 V)} = 0.5$

Accuracy during scaling = $7 \text{ digits} \times 0.5 + 2 = 6 \text{ digits (rounded up)}$

Reference junction compensation:

Internal/External selectable for each channel

Reference junction compensation accuracy (above 0°C):

Types R, S, B, W: $\pm 1^\circ\text{C}$

Types K, J, E, T, N, L, U: $\pm 0.5^\circ\text{C}$

Maximum allowable input voltage:

$\pm 10 \text{ V DC (continuous)}$ for ranges of 2 V or less and TC ranges
 $\pm 60 \text{ V DC (continuous)}$ for 6 VDC, 20 VDC, and 50 VDC ranges

Input resistance: Approximately $10 \text{ M}\Omega$ or more for ranges of 2 V DC or less and TC

Approximately $1 \text{ M}\Omega$ for 6 VDC, 20 VDC, and 50 VDC ranges

Input source resistance:

Volt, TC: $2 \text{ k}\Omega$ or less

RTD: 10Ω or less per wire (The resistance of all three wires must be equal).

Input bias current: 10 nA or less

Maximum common mode noise voltage:

$250 \text{ Vrms AC (50/60 Hz)}$

Maximum noise voltage between channels:

$250 \text{ Vrms AC (50/60 Hz)}$

Interference between channels:

120 dB (when the input source resistance is 500Ω and the inputs to other channels are 60 V)

Common mode rejection ratio:

$120 \text{ dB (50/60 Hz } \pm 0.1\%, 500 \Omega \text{ imbalance, between the minus terminal and ground)}$

Normal mode rejection ratio:

$40 \text{ dB (50/60 Hz } \pm 0.1\%)$

Power Supply

Rated power supply:

$100 \text{ to } 240 \text{ VAC (automatic switching, except for /P1 model)}$
 $24 \text{ VDC/AC (for /P1 model)}$

Allowable power supply voltage range:

$90 \text{ to } 132 \text{ or } 180 \text{ to } 264 \text{ VAC (except for /P1 model)}$
 $21.6 \text{ to } 26.4 \text{ VDC/AC (for /P1 model)}$

Rated power supply frequency:

$50/60 \text{ Hz (automatic switching, for AC)}$

Rated Power consumption:

$62 \text{ VA (except for /P1 model)}$
 $30 \text{ VA (for /P1 model, DC), } 45 \text{ VA (for /P1 model, AC)}$

14.7 General Specifications

Power consumption:

Except for /P1 model

Supply voltage	Backlight saving mode	Normal	Max.
100 VAC	30 VA	32 VA	45 VA
240 VAC	42 VA	47 VA	62 VA

For /P1 model

Supply voltage	Backlight saving mode	Normal	Max.
24 VDC	17 VA	19 VA	30 VA
24 VAC(50/60Hz)	28 VA	32 VA	45 VA

Normal Operating Conditions

Power supply voltage:	90 to 132 or 180 to 250 VAC (except for /P1 model) 21.6 to 26.4 VDC/AC (for /P1 model)
Power supply frequency:	50 Hz $\pm 2\%$, 60 Hz $\pm 2\%$
Ambient temperature:	0 to 50°C (when using FDD or Zip drive: 5 to 40°C)
Ambient humidity:	20% to 80% RH (at 5 to 40°C)
Vibration:	10 to 60 Hz, 0.2 m/s ² or less
Shock:	Not acceptable
Magnetic field:	400 A/m or less (DC and 50/60 Hz)
Noise:	Normal mode (50/60 Hz): Volt: The peak value including the signal must be less than 1.2 times the measuring range. TC: The peak value including the signal must be less than 1.2 times the measuring thermal electromotive force. RTD: 50 mV or less
Common mode noise (50/60 Hz):	250 Vrms AC or less for all ranges
Maximum noise voltage between channels (50/60 Hz):	250 Vrms AC or less
Mounting position:	Can be inclined up to 30 deg backward. Mounting at an angle away from the perpendicular is not acceptable.
Warm-up time:	At least 30 minutes after power on
Altitude:	2000 m or less above sea level

Effects of Operating Conditions

Ambient temperature:	With temperature variation of 10°C: $\pm(0.1\%$ of rdg + 1 digit) or less for Volt and TC ranges Excluding the error of reference junction compensation $\pm(0.1\%$ of rdg + 2 digit) or less for RTD ranges
Power supply:	Except for /P1 model With variation within 90 to 132 V and 180 to 250 VAC (50/60 Hz): ± 1 digit or less With variation of ± 2 Hz from rated power frequency (at 100 VAC): $\pm(0.1\%$ of rdg + 1 digit) or less For /P1 model With variation within 21.6 to 26.4 VDC/AC: ± 1 digit or less With variation of ± 2 Hz from rated power frequency (at 24 VAC): $\pm(0.1\%$ of rdg + 1 digit) or less
Magnetic field:	AC (50/60 Hz) and DC 400 A/m fields: $\pm(0.1\%$ of rdg + 10 digits) or less

Input source resistance:	Volt range
	With variation of +1 k Ω :
	Ranges of 2 V or less: within $\pm 10 \mu\text{V}$
	Ranges of 6 V or greater: $\pm 0.1\%$ of rdg or less
	TC range
	With variation of +1 k Ω :
	Within $\pm 10 \mu\text{V}$ ($\pm 100 \mu\text{V}$ when the burnout upscale/ downscale function is switched on)
	RTD range (Pt100)
	With variation of 10 Ω per wire (resistance of all three wires must be equal):
	$\pm(0.1\%$ of rdg + 1 digit) or less
	With maximum difference of 40 mohms between wires: approximately 0.1 $^{\circ}\text{C}$

Transport and Storage Conditions

The following specifies the environmental conditions required during transportation from shipment to the start of service and during storage as well as during transportation and storage if the DX100L is temporarily taken out of service.

No malfunction will occur under these conditions with serious damage, which is impossible to repair; however, calibration may be necessary to recover normal operation performance.

Ambient temperature:	-25 $^{\circ}\text{C}$ to 60 $^{\circ}\text{C}$
Humidity:	5% to 95% RH (No condensation is allowed).
Vibration:	10 to 60 Hz, 4.9 m/s ² maximum
Shock:	392 m/s ² maximum (while being packed)

Other Specifications

Clock:	With calendar function (year of grace) The time can be adjusted by a remote contact (with the remote control option).
Daylight saving:	Summer and wintertime can be set.
Accuracy of clock:	± 100 ppm, excluding a delay (of 1 second, maximum) caused each time the power is turned on.
Memory backup:	A built-in lithium battery backs up the setup parameters (battery life: approximately ten years at room temperature).
Key lock function:	ON/OFF and password can be set.
Key login function:	Power on with log out mode and all key operations are not permitted. "User name", "User ID" and "password" are required to enter the operation mode.
Insulation resistance:	Each terminal to ground terminal: 20 M Ω or greater (at 500 VDC)

14.7 General Specifications

Dielectric strength:	Power supply to ground terminal: 1500 VAC (50/60 Hz), 1 minute (except for /P1 model)
	Power supply to ground terminal: 500 VAC (50/60 Hz), 1 minute (for /P1 model)
	Contact output terminal to ground terminal: 1500 VAC (50/60 Hz), 1 minute
	Measuring input terminal to ground terminal: 1500 VAC (50/60 Hz), 1 minute
	Between measuring input terminals: 1000 VAC (50/60 Hz), 1 minute (except for b-terminal of RTD input of DX106L and DX112L)
	Between remote control terminal to ground terminal: 500 VDC, 1 minute

Safety and EMC Standards

CSA:	Certified by CSA22.2 No. 61010.1, Installation category II ^{*1} , Pollution degree 2 ^{*2} , Measurement category II ^{*3}
UL:	Certified by UL61010-1 (CSA NRTL/C) Certified by UL61010-1
CE:	
EMC:	Complies with EN61326 (Emission: Class A, Immunity: Annex A) Complies with EN61000-3-2 Complies with EN61000-3-3 Complies with EN55011
Low voltage:	Complies with EN61010-1, Installation category II ^{*1} , Pollution degree 2 ^{*2} , Measurement category II ^{*3}
C-Tick:	Complies with AS/NZS CISPR11 Class A Group 1

*1 "Installation category" describes a number which defines a transient overvoltage condition. It implies the regulation for impulse withstand voltage. "II" applies to electrical equipment which is supplied from the fixed installation like distribution board.

*2 "Pollution degree" describes the degree to which a solid, liquid, or gas which deteriorates dielectric strength or surface resistivity is adhering. "2" applies to normal indoor atmosphere. Normally, only non-conductive pollution occurs.

*3 Applies to measuring circuits connected to low voltage installation, and electrical instruments supplied with power from fixed equipment such as electric switchboards.

14.8 Dimensional Drawings

DX1□□L-1

Unit : mm
(approx.inch)

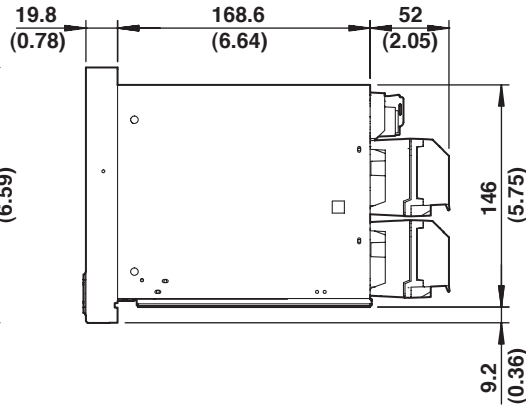
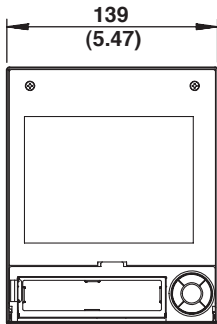
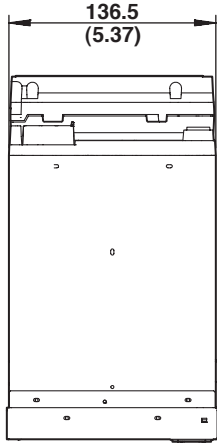

DX1□□L-2

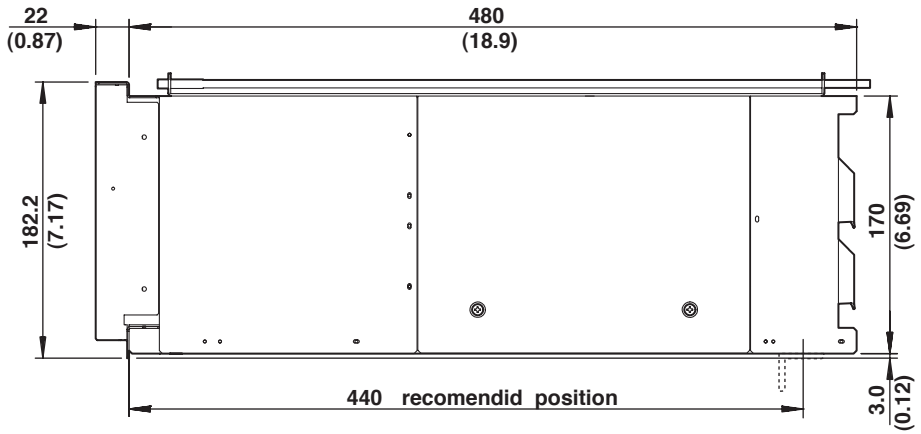
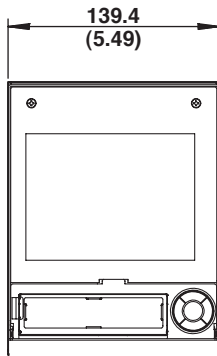

14.8 Dimentional Drawings

DX1□□L-3

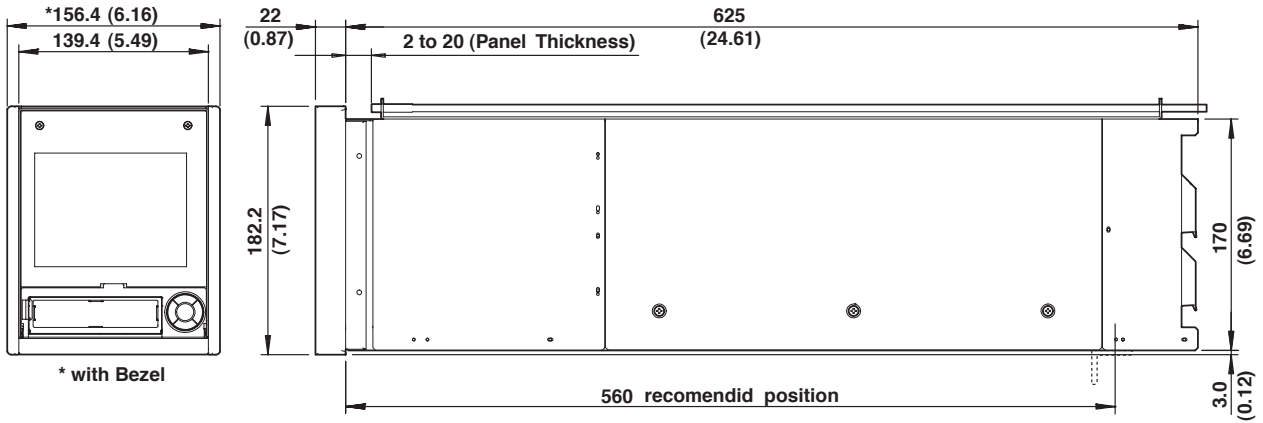
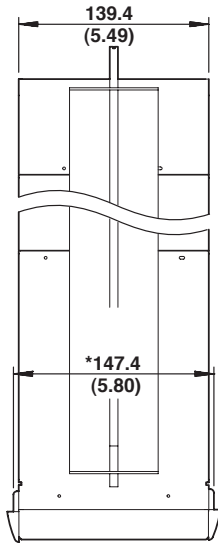

Note

- When mounting the DX100L-2, two mounting brackets are used, one each on the top and bottom of the instrument.
- When mounting the DX100L-3, only one mounting bracket is used, and it is attached to the top of the instrument.
- The dimensional tolerance is $\pm 3\%$ unless otherwise specified. (However, the tolerance for dimensions less than 10 mm is ± 0.3 mm).

Panel Cutout

Unit : mm
(approx.inch)

Panel Cutout & Spacing
for (DX1□□L-2)(DX1□□L-3)

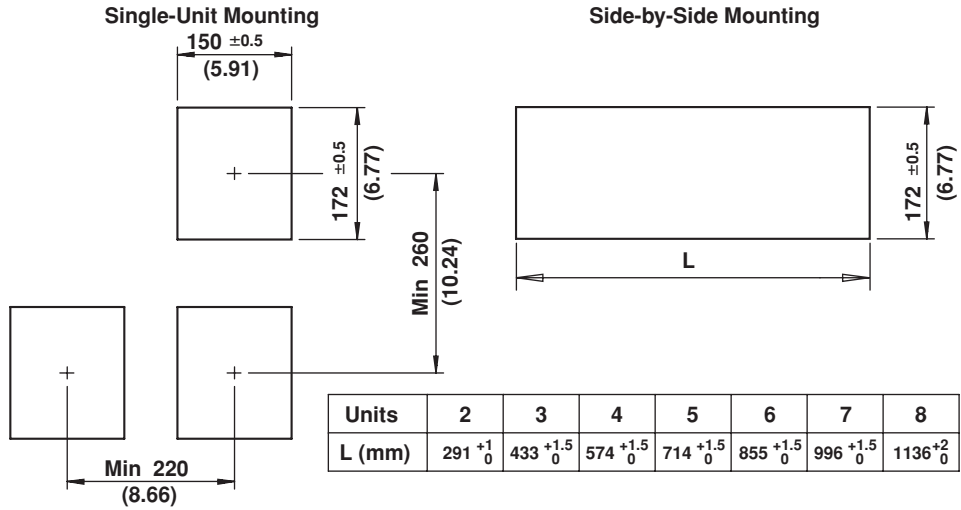

Appendix 1 Parameters and Initial Settings

Setting mode

Initial settings are thick-framed.

Parameters		Menu				Notes	
Range	Volt	20 mV	60 mV	200 mV	2 V	Other parameters: Upper/lower limits of span	
		6 V	20 V	50 V			
	TC	R	S	B	K		
		E	J	T	N		
		W	L	U			
	RTD	PT	JPT			Other parameters: Upper/lower limits of span	
	Scale	Volt	20 mV	60 mV	200 mV	2 V	Other parameters: Upper/lower limits of span Upper/lower limits of scale
			6 V	20 V	50 V		
		TC	R	S	B	K	
			E	J	T	N	
			W	L	U		
		RTD	PT	JPT			
		DI	Level	Cont			
	Unit					Character string	
	Delta	Volt	20 mV	60 mV	200 mV	2 V	Other parameters: Upper/lower limits of span
			6 V	20 V	50 V		
		TC	R	S	B	K	
			E	J	T	N	
			W	L	U		
		RTD	PT	JPT			
		DI	Level	Cont			
	Ref. CH					Up to model types	
	DI	Level	Cont			Other parameters: Upper/lower limits of span	
Sqrt		20 mV	60 mV	200 mV	2 V	Other parameters: Upper/lower limits of span Upper/lower limits of scale	
		6 V	20 V	50 V			
Unit					Character string		
Skip							
Alarm	On/Off	On	Off				
	Type	H	L	h	l		
		R	r	T	t		
	Value					Numerical value	
	Relay On/Off	On	Off				
Number	I01 to I06				Up to model types		
Tag	Tag					Character string, Initial setting is "all space"	
Moving average	Count	Off	2	3	4	DX106L/DX112L	
		5	6	7	8		
		9	10	11	12		
		13	14	15	16		
Filter		Off	2 s	5 s	10 s	DX102L/DX104L	
Alarm delay time		1 s to 3600 s	10 s			Numerical value	
Trend/Save interval	Time/div	15 s	30 s	1 min	2 min	15 s and 30 s are for DX102L and DX104L only	
		5 min	10 min	20 min	30 min		
		1 h	2 h	4 h	10 h		
	Auto save interval	10 min to 31 days	1 h			Up to other parameters set	
Message	Characters No.1 to No.8					Character string, Initial setting is "all space"	
File	Header					Character string, Initial setting is "all space"	
	Directory name					Character string, Initial setting is [DATA 0]	
	Save data	Unsave	All				
Daylight saving time	Summer	On	Off				
	Winter	On	Off				

Appendix 1 Parameters and Initial Settings

Parameters		Menu				Notes	
User key	Action	None	Trigger	Alarm ACK	Math		
		Math rst	M. sample	Message 1	Message 2		
		Message 3	Message 4	Message 5	Message 6		
		Message 7	Message 8	Snapshot			
Group set	Group number	1	2	3	4	Fixed	
	Group name	GROUP 1	GROUP 2	GROUP 3	GROUP 4	Character string	
	CH set					See section 7.6 for initial settings.	
	Trip line	On/Off	On	Off			
		Position					Numerical value
		Color	Red	Green	Blue	B. violet	Initial values are No.1: Red, No.2: Green, No.3: Blue, No.4: Yellow
	Brown	Orange	Y. green	Lightblue			
	Violet	Gray	Lime	Cyan			
Color	CH1 to CH12	Red	Green	Blue	B. violet	See section 14.2 for initial settings.	
		Brown	Orange	Y. green	Lightblue		
		Violet	Gray	Lime	Cyan		
		Darkblue	Yellow	Lightgray	Purple		
Zone	Lower	0 to 95				Numerical value	
	Upper	5 to 100					
Graph	Division	4	5	6	7		
		8	9	10	11		
		12	C10				
	Bar graph	Normal	Center				
	Scale position	1	2	3	4		
Partial	On/Off	On	Off				
	Expand	1 to 99				Numerical value	
	Boundary						
View	Direction	Trend	Horizontal	Vertical	Horizon 2		
		Bar graph	Horizontal	Vertical			
	Background	White		Black			
	Trend line	1	2	3			
	Trip line	1	2	3			
	Grid	Auto	4	5	6		
			7	8	9	10	
			11	12			
	Scroll	5 s	10 s	20 s	30 s		
		1 min					
Scale digit	Normal	Fine					
LCD	Brightness	1	2	3	4		
		5	6	7	8		
	Backlight saver	On/Off	On	Off			
		Saver time	1 min	2 min	5 min	10 min	
		30 min	1 h				
Restore	Key	Key + Alm					
Math color	CH31 to CH60	Red	Green	Blue	B. violet	See section 14.2 for initial settings.	
		Brown	Orange	Y. green	Lightblue		
		Violet	Gray	Lime	Cyan		
		Darkblue	Yellow	Lightgray	Purple		
Math Zone	Lower	0 to 95				Numerical value	
	Upper	5 to 100					
Math partial	On/Off	On	Off				
	Expand	1 to 99				Numerical value	
	Boundary						

Appendix 1 Parameters and Initial Settings

Parameters		Menu				Notes	
Math Graph	Division	4	5	6	7		
		8	9	10	11		
		12	C10				
	Bar graph	Normal	Center				
	Scale position	1	2	3	4		
5		6	Off				
Save/Load, Clear data	Save settings						
	Load settings						
	Save data						
	Load display data						
	Load event data						
	File list						
	Delete						
	Format						
Clear data							
Time set	YY/MM/DD HH: MM: SS					Numerical value	
	DST	Summer	Winter				
Math set	Math range	On/Off	On	Off			
		Calculation expression					Equation for computation
		Span Lower					Numerical value
		Span Upper					
	Unit					Character string	
	Math alarm	On/Off	On	Off			
		Type	H	L	T	t	
		Value					Numerical value
		Relay On/Off	On	Off			
	Number	I01 to I06				Up to model types	
	Constant	K01 to K12				Numerical value, Initial setting is [1]	
	Tag	Tag				Character string, Initial setting is "all space"	
	TLOG	Timer No.	1	2	3		
		Sum scale	Off	/s	/min	/h	
	Rolling average	On/Off	On	Off			
Interval		1 s	2 s	3 s	4 s		
		5 s	6 s	10 s	12 s		
		15 s	20 s	30 s	1 min		
		2 min	3 min	4 min	5 min		
		6 min	10 min	12 min	15 min		
		20 min	30 min	1 h			
Number of samples	1 to 64				Numerical value		
Alarm delay time	1 s to 3600 s	10 s			Numerical value		
Batch set	Application name					Character string, Initial setting is "all space"	
	Supervisor name					Character string, Initial setting is "all space"	
	Manager name					Character string, Initial setting is "all space"	
	Batch number					Character string, Initial setting is "all space"	
	Lot number	0 to 9999	0			Numerical value	
	Auto increment	On	Off				
	Disp information	Batch	Time				

Appendix 1 Parameters and Initial Settings

Basic setting mode

Initial settings are thick-framed.

Parameters	Menu					Notes	
Alarm	Reflash		On	Off			
	Relay	AND	None	I01	I01 - I02	I01 - I03	Up to model types
			I01 - I04	I01 - I05	I01 - I06		
	Action		Energize	De-energ			
	Behavior		Hold	Nonhold			
	Indicator		Hold	Nonhold			
	Rate of change	Increase Decrease	1	2	3	4	
			5	6	7	8	
			9	10	11	12	
			13	14	15		
Hysteresis		On	Off				
A/D	Integrate		Auto	50 Hz	60 Hz	100 ms	Initial setting is 50 Hz for models with /P1. 100 ms is for DX106L and DX112L only
	Scan interval		125 ms	250 ms			
			1 s	2 s			DX106L/DX112L
	Burnout set		Off	Up	Down		
	RJC			Internal	External		
Volt (μ V)						Numerical value	
Temperature unit			C	F			
Memory	Save		Auto	Manual			
	Data		Display	E + D	Event		
	Event	Sample rate	125 ms	250 ms	500 ms	1 s	125 ms, 250 ms, and 500 ms are for DX102L and DX104L only
			2 s	5 s	10 s	30 s	
			60 s	120 s	300 s	600 s	
		Mode	Free	Trigger	Rotate		
	Block		1	2	4	8	1, 2, and 4 when [Data] is set to [E + D]
			16				
	Data length		3 min to 31 days				Up to other parameters set
	Pre-trigger		0	5	25	50	
		75	95	100			
Trigger							
	Key	On	Off				
	External	On	Off				
	Alarm	On	Off				
Memory and trend	Meas CH/Math CH		Meas CH	Math CH			
	First-CH Last-CH					Up to model types	
	On/Off		On	Off			
Memory timeup	Timeup type		Off	Hour	Day	Week	
			Month				
	Date						Numerical value
	Day of the week		SUN	MON	TUE	WED	
			THU	FRI	SAT		
Time (hour)						Numerical value	
AUX	Tag/Channel		Tag	Channel			
	Memory alarm		1 h	2 h	5 h	10 h	
			20 h	50 h	100 h		
	Language		English	Japanese	German	French	
	Partial		Use	Not			
	Batch		Use	Not			for models with /BT1
Time zone		Time difference from GMT		0		Numerical value	

Appendix 1 Parameters and Initial Settings

Parameters		Menu				Notes	
Keylock	Use/Not	Use	Not				
	password					Character string	
	START	Free	Lock				
	STOP	Free	Lock				
	MENU	Free	Lock				
	USER	Free	Lock				
	DISP/ENTER	Free	Lock				
	Alarm ACK	Free	Lock				
	Math	Free	Lock				
	Write memory	Free	Lock				
Media	Free	Lock					
Key login	Use/Not	Use	Not				
	Auto logout	On	Off				
	User ID Use/Not	Use	Not				
	Number	1	2	3	4		
		5	6	7			
	On/Off	On	Off				
	User name	User 1 to User 7				Character string	
	User ID	1 to 7					
	Password						
Enter setup	Enable	Disable					
Save/Load, Initialize	Save settings						
	Load settings						
	Delete						
	Format						
	Initialize						
Option Remote	Action NO.1 to NO.8	None	Start Stop	Trigger	Alatm ACK		
		Time adj	Math Start Stop	Math rst	M. sample		
		Pnl 1 load	Pnl 2 load	Pnl 3 load	Message 1		
		Message 2	Message 3	Message 4	Message 5		
		Message 6	Message 7	Message 8	Snapshot		
Option Timer (TLOG)	Number	1	2	3			
	Mode	Off	Relative	Absolute		Initial setting Timer 1: Absolute Timer 2, 3: Off	
	Interval	(Absolute)	1 min	2 min	3 min		4 min
			5 min	6 min	10 min		12 min
			15 min	20 min	30 min		1 h
			2 h	3 h	4 h		6 h
			8 h	12 h	24 h		
		(Relative)					Numerical value
	Ref. time					Numerical value, Initial setting is [0:00]	
	Reset	On	Off				
Action	Off	Datasave					
Option Report	Report set	Off	Hour	Day	Hour + Day		
		Day + Week	Day + Month				
	Date					Numerical value	
	Date of the week	SUN	MON	TUE	WEN		
		THU	FRI	SAT			
Time (hour)					Numerical value		

Appendix 1 Parameters and Initial Settings

Parameters		Menu				Notes	
Option Report	Report CH	R01	R02	R03	R04		
		R05	R06	R07	R08		
		R09	R10	R11	R12		
	On/Off	On	Off				
	Channel						Up to model types
	Sum scale	Off	/s	/min	/h		
		/day					
Communication Ethernet	IP-address					Numerical value	
	Subnet mask						
	Default gateway						
	DNS On/Off		On	Off			
	Server search order					Numerical value	
		Primary					
		Secondary					
	Host name					Character string	
	Domain name						
	Domain suffix search order					Character string	
	Primary						
	Secondary						
Communication Serial	Baud rate		1200	2400	4800	9600	
			19200	38400			
	Data length		7	8			
	Parity		Even	Odd	None		
	RS-232	Handshaking	Off : Off	XON : XON	XON : RS	CS : RS	
	RS-422 /485	Address	1	2	3	4	
			5	6	7	8	
			9	10	11	12	
			13	14	15	16	
			17	18	19	20	
			21	22	23	24	
			25	26	27	28	
			29	30	31	32	
		Protocol	Normal	Modbus	Modbus - M		
Memory out		Ethernet	Serial				
FTP transfer file	Disp & Event data		On	Off			
	Report		On	Off			
FTP connection		Primary	Secondary				
	FTP server name					Character string	
	Port number		21			Numerical value	
	Login name					Character string	
	Password						
	Account						
	PASV mode		On	Off			
	Initial pass					Character string	
Ethernet login	Use/Not		Use	Not			
	Level	Admin		User 1	User 2	User 3	
		User 4		User 5	User 6		
		On/Off	On	Off			
		User name					Character string
	Password						
Application time out			On	Off			
	Time		1 to 120 min			Numerical value	
Keep alive		On	Off				

Appendix 1 Parameters and Initial Settings

Parameters		Menu				Notes
Web	Use/Not	Use	Not			
	Page type	Operator	Monitor			
	On/Off	On	Off			
	Command	On	Off			for operator page only
	Access control	On	Off			
	User name					Character string
	Password					
Basic E-Mail settings	SMTP server name					Character string
	Port number	25				Numerical value
	Recipient 1					Character string
	Recipient 2					
	Sender					
Alarm E-Mail settings	Recipient 1	On	Off			
	Recipient 2	On	Off			
	Alarm 1	On	Off			
	Alarm 2	On	Off			
	Alarm 3	On	Off			
	Alarm 4	On	Off			
	Include INST	On	Off			
	Include source URL	On	Off			
	Subject	<DX> Alarm_summary				Character string
	Header 1					
Scheduled E-Mail settings	Recipient 1	On	Off			
	Interval	1	2	3	4	
		6	8	12	24	
	Ref. time	00:00				Numerical value
	Recipient 2	On	Off			
	Interval	1	2	3	4	
		6	8	12	24	
	Ref. time	00:00				Numerical value
	Include INST	On	Off			
	Include source URL	On	Off			
Subject	<DX> Periodic_data				Character string	
Header 1						
Header 2						
System E-Mail settings	Recipient 1	On	Off			
	Recipient 2	On	Off			
	Include source URL	On	Off			
	Subject	<DX> System_warning				Character string
	Header 1					
Report E-Mail settings	Recipient 1	On	Off			
	Recipient 2	On	Off			
	Include source URL	On	Off			
	Subject	<DX> Report_data				Character string
	Header 1					
Header 2						

Appendix 1 Parameters and Initial Settings

Parameters		Menu				Notes	
Communication Modbus master Basic settings	Read cycle	125 ms	250 ms	500 ms	1 s		
		2 s	5 s	10 s			
	Timeout	125 ms	250 ms	500 ms	1 s		
		2 s	5 s	10 s	1 min		
	Retrials	Off	1				
		4	5	10	20		
Communication Modbus master command settings	On/Off	On	Off				
	First/Last	C01	C02	C03	C04		
		C05	C06	C07	C08		
		C09	C10	C11	C12		
	Address						Numerical value
	Registers						
	Type	INT16	UINT16	INT32_B	INT32_L		
UINT32_B		UINT32_L	FLOAT_B	FLOAT_L			

Appendix 2 Data Formats of ASCII Files

This section describes the data format of the ASCII file. The DX100L creates two types of ASCII files, the manual sampled data file and the report file.

Data format of the manual sampled data file

- The manual sampled data are output in ASCII format using values and strings that are separated by commas.
- The channel/tag, unit, and manual sampled values are not output for channels in which the input range is set to [Skip] or for which the computation is turned OFF.

Example

The following example is for channels 1, 2, 3, 4, and 31.

```
"MANUAL SAMPLE DATA"
"Model Serial No.:", "XXXXXXXXXXXXXXXXXX"
"File Header : ", "AAAAAAAAAAAAAAAAAAAAAAAAAAAAAAAA"
"CH/TAG", 1 "CH01", "CH02", "CH03", "CH04", "CH31"
"UNIT", "V", "V", "V", "V", "mV"
2000/01/01 01:08:43, 0.000, 0.000, 0.000, -0.014, 12.00
2000/01/01 01:08:48, 0.000, 0.000, 0.000, -0.014, 12.00
2000/01/01 01:09:15, 0.000, 0.000, 0.000, -0.014, 12.00

"CH/TAG", 1 "CH01", "CH02", "CH03", "CH04", "CH31"
"UNIT", "V", "V", "V", "V", "V"
2000/01/01 01:15:30, 0.000, 0.000, 0.000, -0.014, 12.00
2000/01/01 01:18:12, 0.000, 0.000, 0.000, -0.014, 12.00
```

Data size

• Size of the header section

The following equation can be used to derive the size of the header section.

Title + carriage return line feed + serial number + carriage return line feed + file header + carriage return line feed + channel/tag (8 + 19 × number of channels that are output) + carriage return line feed + unit (6 + 9 × number of channels that are output) + carriage return line feed

- The size of the title is fixed to 20 bytes.
- The size of the serial number is fixed to 38 bytes.
- The size of the file header is fixed to 49 bytes.
- The size of the carriage return line feed is fixed to 2 bytes.

Calculation example

Manual sampled data for 12 channels

$$20 + 2 + 38 + 2 + 49 + 2 + (8 + 19 \times 12) + 2 + (6 + 9 \times 12) + 2 = 467 \text{ bytes}$$

• Size of the data section of one data set

The following equation can be used to derive the size of data section of one data set.

Date and time of manual sampling + measured value (8 × number of measurement channel) + computed value (10 × number of computation channels) + carriage return line feed

- The size of the date and time of creation is fixed to 19 bytes.
- The size of the carriage return line feed is fixed to 2 bytes.

Calculation example

Manual sampled data for 12 measurement channels

$$19 + (8 \times 12) + (10 \times 0) + 2 = 117 \text{ bytes}$$

- **Number of data sets and file size**

The file size of 50 data sets* for 12 measurement channels is calculated as follows.

Size of the header section + 50 × size of the data section of one data set = 5900 bytes

* 50 data sets is the maximum number of manual sampled data sets that can be written in the internal memory. If there are more than 50 data sets, they are overwritten starting with the oldest data set.

Note

- Positive (+)/negative (–) over range in measurement channels
Over range occurs when the input type is voltage and the input exceeds ±5% of the measurable range. For example, consider the case when the measurement range is 2 V and the measurable range is from –2.000 to 2.000 V. If the input signal exceeds 2.200 V, + over range occurs. If the input signal falls below –2.200 V, – over range occurs.
Over range occurs when the input type is TC (thermocouple) or RTD (resistance temperature detector) and the input exceeds approximately ±10°C of the measurable range. For example, consider the case when the measurement range is R and the measurable range is from 0.0 to 1760.0°C. If the input signal exceeds approximately 1770.0°C, + over range occurs. If the input signal falls below approximately –10.0°C, – over range occurs.
- Positive (+)/negative (–) computation overflow in computation channels
Positive (+) computation overflow occurs when the value exceeds 3.4E + 38.
Negative (–) computation overflow occurs when the value falls below –3.4E + 38.
- Output value when detected erroneous data, measurement over range data, or computation overflow data

Channels	Data	Output value
Measurement channels	measurement error	Blank
	positive (+) over range	99999
	negative (–) over range	–99999
Computation channels	computation error	999999999
	positive (+) computation overflow	999999999
	negative (–) computation overflow	–999999999

- CH/TAG and UNIT lines
In the following cases, both the CH/TAG line and the UNIT line are rewritten after a carriage return line feed and followed by manual sampled data.
 - When the measurement channel is switched from some setting other than [Skip] to [Skip].
 - When the measurement channel is switched from [Skip] to some other setting.
 - When the computation channels are turned On or turned Off.
 - When the unit is changed.

Four lines from the bottom of the file example shows the output when the unit for channel 31 is changed from “mV” to “V.”
-

Data format of the report file

- The hourly, daily, weekly, and monthly reports are output in ASCII format using values and strings that are separated by commas.
- The channel/tag, unit, average value, maximum value, minimum value, and sum value are not output for channels in which the input range is set to [Skip] or for which the computation is turned OFF.

Example

The following example is the daily report for four channels.

```

"DAILY REPORT", "START TIME", 2000/01/31 20:00
"Model Serial No.:", "XXXXXXXXXXXXXXXXXXXX"
"File Header.:", "AAAAAAAAAAAAAAAAAAAAAAAAAAAAAAAAAAAA"
"CH/TAG", "CH01", "CH02", "CH03", "CH04"
"UNIT", "V", "V", "V", "V"

2000/01/01 00:00, "EOPC", "EOPC", "EOPC", "EOPC"
"AVE", 0.00, 0.10, 0.20, 0.30
"MAX", 0.00, 1.00, 2.00, 3.00
"MIN", 0.00, -1.00, -2.00, -3.00
"SUM", 0.000000E-01, 1.000000E+04, 2.000000E+04, 3.000000E+04
    
```

Status

- Various events that occur while creating the report data are saved as status data and output in the report.
- The positions of the various statuses in the report are fixed.

- E: Error (an error is detected)
- O: Over (an over range/computation overflow is detected)
- P: Power failure (a power disruption has occurred)
- C: Change (the time has been changed)

Data size

• **Size of the header section**

The following equation can be used to derive the size of the header section.

Title + carriage return line feed + serial number + carriage return line feed + file header + carriage return line feed + channel/tag (8 + 19 × number of channels that are output) + carriage return line feed + unit (6 + 9 × number of channels that are output) + carriage return line feed

- The size of the title varies depending on the report type as follows.
 - For hourly reports (HOURLY): 45 bytes
 - For daily reports (DAILY): 44 bytes
 - For weekly reports (WEEKLY): 45 bytes
 - For monthly reports (MONTHLY): 46 bytes
- The size of the serial number is fixed to 38 bytes.
- The size of the file header is fixed to 49 bytes.
- The size of the carriage return line feed is fixed to 2 bytes.

Calculation example

Monthly data for 12 channels

$$46 + 2 + 38 + 2 + 49 + 2 + (8 + 19 \times 12) + 2 + (6 + 9 \times 12) + 2 = 493 \text{ bytes}$$

- **Size of the data section of one report data set**

The following equation can be used to derive the size of data section of one report data.

Carriage return line feed + date and time of creation + status (11 × number of channels that are output) + carriage return line feed + average value (5 + 14 × number of channels that are output) + carriage return line feed + maximum value (5 + 14 × number of channels that are output) + carriage return line feed + minimum value (5 + 14 × number of channels that are output) + carriage return line feed + sum value (5 + 14 × number of channels that are output) + carriage return line feed

- The size of the date and time of creation is fixed to 16 bytes.
- The size of the carriage return line feed is fixed to 2 bytes.

Calculation example

Monthly data for 12 channels

$$2 + 16 + (11 \times 12) + 2 + (5 + 14 \times 12) + 2 + (5 + 14 \times 12) + 2 + (5 + 14 \times 12) + 2 + (5 + 14 \times 12) + 2 + (5 + 14 \times 12) + 2 = 852 \text{ bytes}$$

- **Number of report data sets and file size**

The file size varies depending on the number of report data sets as follows.

- One report data set of monthly reports
Size of the header section + size of the data section of one report data set = 3055 bytes

- 40 report data sets* of monthly reports
Size of the header section + 40 × size of the data section of one report data set = 83317 bytes

* 40 report data sets is the maximum number of report data sets that can be written in the internal memory. If there are more than 40 data sets, they are cleared starting with the oldest data set.

Note

- When the measurement and computation channel data enter the condition described in the following table, status “E” and “O” are output in the report.

Data Condition	Status
Common to measurement and computation channels Measurement error or computation error	E
For measurement channels	
Positive (+) over range	O
Negative (–) over range	O
Over range occurs when the input type is voltage and the input exceeds ±5% of the measurable range. For example, consider the case when the measurement range is 2 V and the measurable range is from –2.000 to 2.000 V. If the input signal exceeds 2.200 V, + over range occurs. If the input signal falls below –2.200 V, – over range occurs. Over range occurs when the input type is TC (thermocouple) or RTD (resistance temperature detector) and the input exceeds approximately ±10°C of the measurable range. For example, consider the case when the measurement range is R and the measurable range is from 0.0 to 1760.0°C. If the input signal exceeds approximately 1770.0°C, + over range occurs. If the input signal falls below approximately –10.0°C, – over range occurs.	
For computation channels	
Positive (+) computation overflow (when the value exceeds 3.4E + 38)	O
Negative (–) computation overflow (when the value falls below –3.4E + 38)	O

- Measurement/computation errors are discarded when MAX and MIN are determined.
- Measurement/computation errors, over range, and computation overflow are discarded when determining AVE and SUM.
- The report output values of AVE, MAX, MIN and SUM vary depending on the data condition of the measurement and computation channels as shown in the table below.

Item	Data Condition of Measurement Channels	Report Output Value
AVE (Average value)	When all data are measurement errors or over range	(Blank)
MAX, MIN (Maximum value, minimum value)	<ul style="list-style-type: none"> • When all data are measurement errors • Positive (+) over range • Negative (-) over range 	(Blank) 99999 -99999
SUM (Sum value)	<ul style="list-style-type: none"> • When all data are measurement errors or over range • When the sum value exceeds $3.4E + 38$ • When the sum value is below $-3.4E + 38$ 	(Blank) 9.999999E + 99 -9.999999E + 99

Item	Data Condition of Computation Channels	Report Output Value
AVE (Average value)	When all data are computation errors or over range	(Blank)
MAX, MIN (Maximum value, minimum value)	<ul style="list-style-type: none"> • When all data are computation errors • When the maximum value exceeds 99999999 • When the minimum value is below -9999999 	(Blank) 99999999 -99999999

The decimal position that was specified when the span for the equation was specified is reflected in the maximum and minimum values. For example, if the span setting of the equation is "200.0," then "99999999" is output when the value exceeds "99999999.9" and "-99999999" is output when the value is below "-999999.9."

SUM (Sum value)	<ul style="list-style-type: none"> • When all data are computation errors or computation overflow • When the sum value exceeds $3.4E + 38$ • When the sum value is below $-3.4E + 38$ 	(Blank) 9.999999E + 99 -9.999999E + 99
--------------------	--	--

Appendix 3 The Relationship between Style Numbers and Functions

The following table shows the relationship between the style numbers and the functions that have been added or changed.

Functions that have been added on style number “S2”

- Batch function (/BT1 option)
- Cramped input terminal (/H2 option)
- Cu10 and Cu25 RTD input/three-wire isolated RTD input (/N1 option)
- 24 V DC/AC power supply (/P1 option)
- Delay upper/lower limit alarm function
- Automatic switching function of displayed groups
- Memory information on historical trend display
- Historical trend display of event data
- Function used to store the data to the external storage medium using key operation during auto save mode
- German and French as displayed language
- System screen
- Conformity to Water and Dust-Proof Specification NEMA NO.250 TYPE4
- Certified by UL3111-1 (CSA NRTL/C)

Functions that have been added on style number “S4”

- 24 VDC power supply for transmitter (/TPS2 or /TPS4)
- Fieldbus communication interface (/CF1)
- Web server function
- E-mail transmission function
- Modbus master function
- Communication command for key operation
- Communication output of alarm summary and message summary
- 50 VDC input range
- Combination of hourly and daily report
- Alarm output relay condition is held in the basic setting mode
- Horizontal display type 2 for trend screen
- [C10] scale division and [FINE] scale digit
- [AUTO] grid
- Memory timeout function
- Display update rate 15 s, 30 s, and 10h
- Event data sampling interval 300 s and 600 s
- Memory end alarm [OFF]
- German and French for all screens
- Snapshot as remote control function
- Improved display format for a group with three channels

Index

A

absolute mode	11-15
absolute value	11-1
access lamp	3-2
accessories (sold separately)	viii
accessories (standard)	vii
adjusting the internal clock (remote control)	10-14
alarm (computation)	11-3
Alarm ACK	6-1
alarm function	1-17
alarm hysteresis	1-19
alarm icon	4-4, 6-1
alarm mark	6-2, 6-3
alarm output relay	1-19
alarm point mark	6-3
alarm summary	1-10
alarm trigger	8-5
all channel display	1-7, 4-9
AND/OR	6-12
application name	1-22
arithmetical operations	11-1
ASCII file	App-9
ATA flash memory card	3-5
auto logout	10-7
auto save	1-16, 8-10
auto save interval	8-19
automatic increment of the lot number	10-20
automatic switching of displayed group	7-23

B

background color	1-14
backlight saver	1-14
bar graph screen	1-9
base position	1-9, 7-19
basic setting mode	3-7, 3-10
batch function	1-22
batch information	1-22
batch name	1-22
batch number	1-22
batch screen	10-17
block	8-4, 8-24
brightness	1-14
burnout	1-3

C

calibration	13-3
capacity (internal memory)	8-6
cautions (messages)	12-8
Celsius	10-24
channel assignment (group)	7-8
channel display area	6-3
channel display color	7-12
channel number display	1-5
channels to acquire the data	8-22
channels to display the trend	8-22
clearing computed results (remote control)	10-14
clearing data	9-14
clearing the character string	3-22
combinations of user IDs and passwords	1-22
comment	1-22

common logarithm	11-1
communication input data	11-2
computation channels	11-1
computation dropout display	11-9
computation function	1-20, 11-1
computation icon	4-4
computation operators	
-	11-4
+	11-4
.EQ.	11-5
.GT.	11-5
.LE.	11-5
.LT.	11-5
.NE.	11-5
/	11-4
ABS	11-4
AND	11-5
EXP	11-4
LOG	11-4
NOT	11-6
OR	11-6
SQR	11-4
TLOG.AVE	11-7
TLOG.MAX	11-7
TLOG.MIN	11-7
TLOG.P-P	11-7
TLOG.SUM	11-7
XOR	11-6
*	11-4
**	11-4
conditions of the remote control terminals	11-2
constants	11-1
contact specifications (alarm)	2-10
contact specifications (FAIL/memory end)	2-12
copying a character strings	3-22
cursor (historical trend)	1-13
cursor (overview)	1-10

D

daily report	11-22
data acquisition (display data)	8-3
data acquisition (event data)	8-4
data acquisition (manual sampled data)	8-9
data acquisition (report data)	8-9
data acquisition (TLOG data)	8-9
data display section	1-5
data formats of ASCII files	App-9
data length	8-4, 8-24, 8-25
data used in computation	11-1
date and time	3-23
date and time (entering comment)	10-18
daylight savings time	1-28
DC current	1-3
DC voltage	1-2
DDR	8-2
DDS	8-2
delay lower limit alarm	1-18
delay upper limit alarm	1-18
deleting directories	9-10, 9-12
deleting files	9-9, 9-12
Delta	1-2
DEV	8-2

Index

DI 1-2
difference 1-2
difference lower limit alarm 1-18
difference upper limit alarm 1-18
digital input 1-2
digital screen 1-9
digits of the scale values 7-18
dimensional drawings 14-19
directory name 8-20
directory name (manual save) 8-16
directory name (saving data using key operation) 9-5
display conditions of the LCD 1-14
display data 1-15, 8-1
display direction (bar graph) 1-9
display direction (trend) 1-7
display reference position 1-13
display update rate 1-6
displayed color (bar graph) 1-9
displayed color (message) 7-6
displayed color (trend) 1-7
displayed color (trip line) 7-11
displayed data of the waveform 1-7
displayed data type (historical trend) 4-14
displayed information 10-20
displayed language 1-26
dividing report files 8-11
DMN 8-2
DMR 8-2
DTG 8-2
DWR 8-2

E

e-mail transmission function icon 4-4
eject button 3-2
energize/de-energize (alarm output relay) 6-12
entering characters 3-22
entering numbers 3-21
error messages 12-1
ESC key 3-2
Ethernet port 3-3
event data 1-15, 8-1
expanding the time axis 4-19
exponent 11-1
extension 8-2
external storage medium (handling) 2-2
external storage medium condition 4-4
external trigger 8-5
external trigger for event data (remote control) 10-14

F

Fahrenheit 10-24
FAIL/memory end output 1-26
FDISK 9-11
file format 9-13
file header 8-20
file name 8-2, 9-1, 9-3, 9-13
filter 1-3
format time 9-11
format type 9-11
formatting 9-11, 9-12
free 8-4
free space 9-8
front cover 3-1
front panel 3-1
FTP test 3-8
FUNC key 3-2, 3-8

G

grid 7-24
group display 1-5, 4-9

H

H 6-6
h 6-6
half screen display 1-13
historical trend 1-12
hold/non-hold (alarm indication) 6-13
hold/non-hold (alarm output relay) 6-13
hourly report 11-22

I

Initial settings (basic setting mode) App-4
Initial settings (setting mode) App-1
initializing 9-15
input specifications (remote control) 2-14
input terminals 3-3
input type 1-2
installation 2-3
integration time 1-4
internal memory 1-15
interval (rate-of-change alarm) 1-19

K

key 3-2
key lock 1-24
key lock icon 4-4
key login function (with batch function) 1-22
key login/logout 1-25
key operations (basic setting mode) 3-19
key operations (setting mode) 3-20
key panel cover 3-1
key trigger 8-5

L

L 6-6
l 6-6
label 3-1
LCD 1-5
list of files 9-8
load the setup data (remote control) 10-15
loading setup data (basic setting mode) 9-4
loading setup data (setting mode) 9-2
log (communication command) 10-11
log (e-mail) 10-11
log (error message) 10-10
log (FTP) 10-11
log (key login/logout) 10-11
log (web operation) 10-11
log display 1-25
logical computation 11-1
logical format 9-11
lot number 1-22
lower limit alarm 1-17
lower limit on rate-of-change alarm 1-18

M

MAC address 1-25

maintenance 13-1
 manager name 1-22
 manual sampled data 1-16, 8-1
 manual sampled data file (data format) App-9
 manual sampling (remote control) 10-14
 manual save 1-16, 8-10
 mark 6-4
 maximum number of data points per channel 8-7
 measurable range (DC volt) 5-2
 measurable range (DI) 5-6
 measurable range (difference computation) 5-8
 measurable range (RTD) 5-4
 measurable range (TC) 5-4
 measurement channels 1-2
 memory information 4-20
 memory summary 1-11
 memory timeup 8-26
 MENU key 3-2
 message 1-7
 message string 7-7
 message summary 1-11
 mode 8-24
 model v
 monthly report 11-22
 moving average 1-3

N

normal (formatting) 9-11
 number of alarms 1-17
 number of data bytes per channel 8-6
 number of display data files 8-3
 numerical display (report) 11-24
 numerical display section 1-8

O

operation mode 3-7
 operation screen 4-1
 option terminals 3-3
 order of precedence of the operators 11-2
 over display range (computation) 11-3
 over range (measurement) 1-3, 11-24
 overflow 11-3
 overview screen 1-10

P

panel cutout 14-21
 partial expanded display 1-8
 password (key lock) 10-4
 password (key login) 10-9
 periodic maintenance 13-1
 physical format 9-11
 PNG 9-13
 PNL 9-1
 power (computation) 11-1
 power supply 2-17, 2-18
 power supply for transmitter 1-28
 power switch 3-2
 power terminals 3-3
 pretrigger 8-5
 protective ground terminal 3-3

Q

quick 9-11

R

R 6-6
 r 6-7
 range (computation channel) 11-11
 range (scaling) 5-10
 rear panel 3-3
 reducing the time axis 4-19
 reference channel 5-8
 reference junction compensation 1-3
 reflash 6-11
 relational computation 11-1
 relative mode 11-15
 releasing the alarm 6-1
 releasing the alarm (remote control) 10-14
 remote control function 1-27
 remote signal 1-27
 removing zip disk 3-6
 replacement periods for worn parts 13-5
 replacing the fuse 13-2
 report data 1-16, 8-1
 report data display 1-12
 report date 11-27
 report day of the week 11-27
 report file (data format) App-11
 report function 1-21, 11-22
 report time 11-27
 reset (TLOG) 11-16
 resistance temperature detector 1-2
 revision history x
 rising/falling edge 1-27
 RJC 1-3
 rolling average 11-3
 rotate 8-5
 RTD 1-2
 rules for writing an equation (common items) 11-7
 run mode 3-7

S

sample rate 8-24
 sampling interval (display data) 1-7
 sampling interval (event data) 8-24
 sampling length 8-7
 saved data (manual save) 8-20
 saving data to the external storage media 1-16
 saving data using key operation 9-5
 saving data via Ethernet 1-16
 saving setup data (basic setting mode) 9-3
 saving setup data (setting mode) 9-1
 saving the data using key operation (auto save) 8-17
 scale (bar graph) 1-9
 scale (trend) 1-8
 scale display position 7-17
 scale marks 7-18
 scale specifications 7-17
 scale values 7-18
 scaling 1-2
 scan interval 1-2
 screen menu 4-1
 sequence number 8-2, 8-16, 9-5, 9-13
 serial interface port 3-3
 serial number vii, 1-22
 setting items (basic setting mode) 3-17
 setting items (setting mode) 3-14
 setting mode 3-7, 3-10
 setting screen 1-14

Index

settings (alarm) 3-11
settings (computation) 3-12
settings (data storage) 3-12
settings (display) 3-11
settings (input) 3-11
setup mode 3-7
shunt resistor 5-2
skip 1-2
snapshot 9-13
soft key
 [+] 11-14
 [A/a/1] 3-22
 [BS] 3-22
 [Clear] 3-22
 [Copy] 3-22
 [DEL] 3-22
 [E+D] 8-24
 [E] 11-14
 [INS] 3-22
 [Paste] 3-22
soft keys 3-2
software viii
specifications
 24 VDC power supply for transmitter 14-13
 24 VDC/AC power supply 14-12
 3 terminal isolated RTD input 14-12
 alarm 14-8
 alarm output relays 14-10
 batch function 14-10
 clamped input terminal 14-11
 communication (Ethernet) 14-9
 computation functions 14-11
 Cu10, Cu25 RTD input 14-12
 data storage 14-5
 dimensional drawings 14-19
 display 14-3
 FAIL/memory end output 14-11
 fieldbus communication interface 14-11
 general 14-14
 input 14-1
 normal operating conditions 14-16
 power supply 14-15
 remote control 14-13
 serial communication interface 14-10
 standard operation conditions 14-14
speed of movement of waveform 1-6
Sqrt 1-2
square root 1-2, 11-1
square-root computation 5-12
stacks 11-7
START key 3-2
start/stop computation (remote control) 10-14
start/stop data acquisition (remote control) 10-14
statistical computation 11-1
status (report) 11-23
status display section 1-5, 4-2
status messages 12-8
STOP key 3-2
storage function 1-15
storage medium drive 3-2
style number i, App-14
sub menu 4-1
sum scale (report) 11-22
sum scale (TLOG) 11-15
summer/winter 10-22
supervisor name 1-22
system errors 12-8
system screen 1-25

T

T 6-7
t 6-7
tag display 1-5
TC 1-2
temperature unit 1-28
thermocouple 1-2
time zone 10-25
timer 11-15
timeup 8-26
TLOG computation 11-15
TLOG data 1-16, 8-1
trend screen 1-6
trigger 8-4
trigger (remote signal) 1-27
trip line 1-7
troubleshooting 12-9

U

unit (computation) 11-11
unit (scale) 7-19
unit (scaling) 5-10
unit (square-root computation) 5-12
unit handling 11-2
updating (bar graph) 1-9
updating (digital) 1-9
updating (overview) 1-10
updating (trend) 1-6
upper limit alarm 1-17
upper limit on rate-of-change alarm 1-18
usage condition (internal memory) 4-3
user ID 10-9
USER key 1-24, 3-2
user name 10-9

V

version number 1-25
viewing display data 9-6
viewing event data 9-7
volume name 9-11

W

waveform lines 1-7
weekly report 11-22
wiring (alarm output) 2-9
wiring (FAIL/memory end) 2-11
wiring (input signal) 2-5
wiring (power supply) 2-17
wiring (remote control) 2-13
wiring (transmitter power supply) 2-15
writing messages (remote control) 10-15

Z

zone display 1-8